



**TOTAL AIR ANALYSIS, INC.**

## SOURCE TEST FOR EMISSION FACTORS

### ONE FLARE CITY OF SANTA MARIA LANDFILL

Prepared For:

***Janechek & Associates***

248 Hill Place  
Costa Mesa, CA 92627

Prepared By:

***Total Air Analysis, Inc.***

1210 East 223<sup>rd</sup> Street, Suite 314  
Carson, CA 90745

***Test Date:*** September 9 - 11, 2010

***Report Identification No:*** JA-100887

Prepared by:

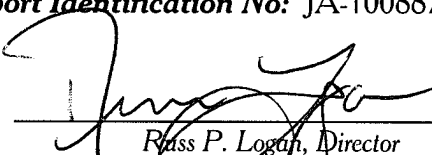
  
\_\_\_\_\_  
Russ P. Logan, Director

Reviewed by:

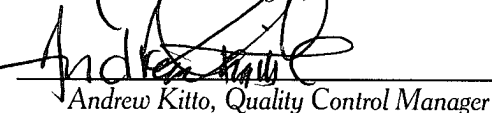
  
\_\_\_\_\_  
Andrew Kitto, Quality Control Manager

Submitted To:

***Santa Barbara County Air Pollution Control District***

260 N San Antonio Rd, Suite A  
Santa Barbara, CA 93110-1315

# TABLE OF CONTENTS

	<u>Page</u>
1.0 Summary of Results .....	1
2.0 Introduction .....	2
3.0 Equipment and Process Description .....	2
4.0 Rule/Compliance Requirements.....	3
5.0 Test Description.....	4
6.0 Sampling and Analytical Procedures .....	5
6.1 CARB Method 100 - Continuous Gaseous Emissions Sampling.....	5
6.2 CARB Method 425 - Hexavalent Chromium Emissions .....	8
6.3 CARB Method 429 - Determination of PAHs.....	8
6.4 CARB Method 430 - Determination of Acetaldehyde and Formaldehyde .....	9
6.5 CARB Method 436 - Multiple Metals Emission Determination .....	9
6.6 EPA Method 18 - Measurement of Gaseous Organic Emissions by Gas Chromatography.....	10
6.7 EPA Method 19 - Volume Flow Determination by Fuel.....	11
6.8 EPA Method 26 - Hydrochloric Acid (HCL) Emissions Determination ...	11
7.0 Quality Assurance/Quality Control .....	11
7.1 QA/QC Overview.....	12
7.2 QA/QC Equipment Calibration Procedures.....	12

## **LIST OF APPENDICES**

- Appendix A - *CARB Method 100* – NO<sub>x</sub>, CO, O<sub>2</sub>, CO<sub>2</sub>  
Calculation Spreadsheets, DAS, and Strip Charts**
- Appendix B - *CARB Method 425* – Hexavalent Chrome  
Calculation Spreadsheets, Analytical Results, and Field Data Sheets**
- Appendix C - *CARB Method 429* – PAHs Emissions  
Calculation Spreadsheets, Analytical Results, and Field Data Sheets**
- Appendix D - *CARB Method 430* - Formaldehyde  
Calculation Spreadsheets, Analytical Results, and Field Data Sheets**
- Appendix E - *CARB Method 436* – Multiple Metals  
Calculation Spreadsheets, Analytical Results, and Field Data Sheets**
- Appendix F - *EPA Method 18* –Acrylonitrile, 1,4-Dioxane  
Calculations and Analytical Results**
- Appendix G - *EPA Method 19* – Volume Flow Calculation  
Analytical Results and Fuel Meter Calibration**
- Appendix H - *EPA Method 26* – Acids, HCL, and HF  
Calculation Spreadsheets, Analytical Results, and Field Data Sheets**
- Appendix I - Facility Flare Process Data**
- Appendix J - Quality Assurance/Quality Control**
- Appendix K - CARB Independent Source Test Contractor Certificate**

## 1.0 SUMMARY OF RESULTS

**Facility:** Santa Maria Landfill  
**Source:** Flare  
**Load:** Normal  
**Start Date:** 9/9/2010

Parameter	Units	Run 1	Run 2	Run 3	Average
<b>NO<sub>x</sub></b>	ppmv	14.19	13.74	14.01	13.98
<b>Emission Rate</b>	lb/hr	0.32	0.31	0.30	0.31
<b>Emission Rate</b>	lb/MMBtu	<b>0.050</b>	<b>0.048</b>	<b>0.049</b>	<b>0.049</b>
<b>CO</b>	ppmv	0.82	0.38	0.001	0.40
<b>Emission Rate</b>	lb/hr	0.01	0.01	0.00001	0.01
<b>Emission Rate</b>	lb/MMBtu	<b>0.002</b>	<b>0.002</b>	<b>0.00001</b>	<b>0.001</b>
<b>VOCs, Acrylonitrile*</b>	ppbv	2.3	2.3	2.3	2.3
<b>Emission Rate</b>	lb/hr	6.41E-05	6.26E-05	6.35E-05	6.34E-05
<b>Emission Rate</b>	lb/MMBtu	<b>9.87E-06</b>	<b>9.79E-06</b>	<b>1.04E-05</b>	<b>1.00E-05</b>
<b>VOCs, 1,4-Dioxane*</b>	ppbv	1.4	1.4	1.4	1.4
<b>Emission Rate</b>	lb/hr	6.48E-05	6.32E-05	6.42E-05	6.41E-05
<b>Emission Rate</b>	lb/MMBtu	<b>9.98E-06</b>	<b>9.90E-06</b>	<b>1.05E-05</b>	<b>1.01E-05</b>
<b>O<sub>2</sub></b>	%	14.08	14.08	14.12	14.09
<b>CO<sub>2</sub></b>	%	5.65	5.65	5.61	5.64
<b>Heat Input</b>	MMBtu/Hr	6.50	6.39	6.12	6.33
<b>Flow (measured)</b>	dscfm	<b>3,320</b>	<b>3,238</b>	<b>3,288</b>	<b>3,282</b>
<b>Flow (calculated)</b>	dscfm	3,180	3,126	3,008	3,105

Note: All emission rates were computed using measured flow rate, calculated flow (fuel usage) is shown for CO<sub>2</sub>.  
 \* Laboratory analysis was Non-Detect, Reporting limits used for emissions shown.

## 1.1 SUMMARY OF RESULTS, PAHs

**Source:** Flare  
**Load:** Normal  
**Start Date:** 9/9/10  
**End Date:** 9/10/10

### City of Santa Maria, Landfill Gas Flare #1

Target Compounds	Lab result ug/sample	Emissions ug/cu ft	MW lb/lb-mole	Emissions mg/dscm	Emissions ppm	Flow Rate dscfm	Emissions lbs/hr
Naphthalene	0.406	0.0054	128.2	0.000189	3.60E-05	3,282	2.36E-06
2-methylnaphthalene	0.22176667	0.0029	142.0	0.000103	1.78E-05	3,282	1.29E-06
Acenaphthylene	0.2532	0.0033	154.2	0.000118	1.87E-05	3,282	1.47E-06
Acenaphthene	0.01633333	0.0002	152.0	0.000008	1.22E-06	3,282	9.51E-08
Fluorene	0.65736667	0.0087	166.2	0.000306	4.50E-05	3,282	3.83E-06
Phenanthrene	2.281	0.0301	178.2	0.001062	1.46E-04	3,282	1.33E-05
Anthracene	0.02563333	0.0003	178.2	0.000012	1.64E-06	3,282	1.49E-07
Fluoranthene	0.03253333	0.0004	202.0	0.000015	1.83E-06	3,282	1.89E-07
Pyrene	0.07053333	0.0009	202.2	0.000033	3.97E-06	3,282	4.11E-07
Chrysene	0.0151	0.0002	228.3	0.000007	7.53E-07	3,282	8.79E-08

**Lab Result is average of three samples**

The Detection Limit is used for ND Laboratory results.

## 1.2 SUMMARY OF RESULTS, Metals

**Facility:** Santa Maria Landfill  
**Source:** Flare  
**Load:** Normal  
**Start Date:** 9/9/2010

Parameter	Units	Run 1	Run 2	Run 3	Average
<b>Arsenic</b>	ug/sample	150.8	129.8	148.6	143.1
<b>Arsenic</b>	gr/dscf	3.31E-05	2.61E-05	6.81E-07	2.00E-05
<b>Emission Rate</b>	lb/hr	9.32E-04	7.39E-04	8.26E-04	8.32E-04
<b>Emission Rate</b>	lb/MMBtu	<b>1.43E-04</b>	<b>1.16E-04</b>	<b>1.35E-04</b>	<b>1.31E-04</b>
<b>Cadmium</b>	ug/sample	3.4200	3.4600	3.4800	3.4533
<b>Cadmium</b>	gr/dscf	7.50E-07	6.96E-07	6.81E-07	7.09E-07
<b>Emission Rate</b>	lb/hr	2.11E-05	1.97E-05	1.94E-05	2.01E-05
<b>Emission Rate</b>	lb/MMBtu	<b>3.25E-06</b>	<b>3.08E-06</b>	<b>3.17E-06</b>	<b>3.17E-06</b>
<b>Chromium(Total)</b>	ug/sample	0.0407	0.0244	0.0321	0.0324
<b>Chromium(Total)</b>	gr/dscf	3.05E-06	1.70E-06	2.19E-06	2.31E-06
<b>Emission Rate</b>	lb/hr	8.60E-05	4.81E-05	6.21E-05	6.54E-05
<b>Emission Rate</b>	lb/MMBtu	<b>1.32E-05</b>	<b>7.52E-06</b>	<b>1.02E-05</b>	<b>1.03E-05</b>
<b>Nickel</b>	ug/sample	3.4200	3.4600	3.4800	3.4533
<b>Nickel</b>	gr/dscf	7.50E-07	6.96E-07	6.81E-07	7.09E-07
<b>Emission Rate</b>	lb/hr	2.11E-05	1.97E-05	1.94E-05	2.01E-05
<b>Emission Rate</b>	lb/MMBtu	<b>3.25E-06</b>	<b>3.08E-06</b>	<b>3.17E-06</b>	<b>3.17E-06</b>
<b>Manganese</b>	ug/sample	3.4200	14.5666	3.4800	7.1555
<b>Manganese</b>	gr/dscf	7.50E-07	2.93E-06	6.81E-07	1.45E-06
<b>Emission Rate</b>	lb/hr	2.11E-05	8.29E-05	1.94E-05	4.11E-05
<b>Emission Rate</b>	lb/MMBtu	<b>3.25E-06</b>	<b>1.30E-05</b>	<b>3.17E-06</b>	<b>6.47E-06</b>
<b>O<sub>2</sub></b>	%	14.08	14.08	14.12	14.09
<b>CO<sub>2</sub></b>	%	5.65	5.65	5.61	5.64
<b>Heat Input</b>	MMBtu/Hr	6.50	6.39	6.12	6.33
<b>Flow (measured)</b>	dscfm	3320.35	3237.89	3287.61	3,282
<b>Flow (calculated)</b>	dscfm	3179.95	3126.21	3008.31	3,105

### 1.3 SUMMARY OF RESULTS

Facility: Santa Maria Landfill

Source: Flare

Load: Normal

Start Date: 9/10/10

End Date: 9/11/10

Parameter	Units	Run 4	Run 5	Run 6	Average
Formaldehyde	ppmv	0.17	0.20	0.08	0.15
Emission Rate	lb/hr	2.66E-03	3.12E-03	1.40E-03	2.39E-03
Emission Rate	lb/MMBtu	3.94E-04	4.62E-04	2.23E-04	3.60E-04
Hydrogen Fluoride (HF)	ppmv	0.430	0.233	0.207	0.29
Emission Rate	lb/hr	4.36E-03	2.38E-03	1.97E-03	2.90E-03
Emission Rate	lb/MMBtu	6.46E-04	9.81E-04	8.12E-04	8.13E-04
Hydrochloric Acid (HCL)	ppmv	0.002	0.003	0.003	0.003
Emission Rate	lb/hr	2.13E-05	2.27E-05	2.12E-05	2.18E-05
Emission Rate	lb/MMBtu	3.16E-06	3.37E-06	3.38E-06	3.30E-06
Hexavalent Chrome	ug/Sample	0.0647	0.0820	0.0527	0.0665
Hexavalent Chrome	gr/dscf	1.26E-08	2.44E-09	2.30E-09	5.79E-09
Emission Rate	lb/hr	3.59E-07	6.86E-08	6.47E-08	1.64E-07
Emission Rate	lb/MMBtu	5.32E-08	1.02E-08	1.03E-08	2.45E-08
O <sub>2</sub>	%	13.84	13.88	13.89	13.87
CO <sub>2</sub>	%	5.71	5.57	5.52	5.60
Heat Input	MMBtu/Hr	6.75	6.75	6.29	6.60
Flow (measured)	dscfm	3,312	3,282	3,286	3,293
Flow (calculated)	dscfm	3,199	3,220	3,004	3,141

All emission rates computed using measured flow, calculated flow (fuel) is shown for comparison.

## **2.0 Introduction**

Total Air Analysis, Inc. was contracted by Janechek & Associates to perform an emissions factor source test program on a Flare at the City of Santa Maria Landfill. The objective of the source test was to determine concentrations and emission rates of specific compounds from the exhaust of the Flare. The Flare was tested for Poly-Aromatic Hydrocarbons (PAHs), multiple metals including Hexavalent Chrome (Cr6), Formaldehyde, Hydrogen Chloride (HCL) and Hydrogen Fluoride (HF) Acids, and VOCs; Acrylonitrile, and 1,4-Dioxane. NOX/CO/CO<sub>2</sub> and O<sub>2</sub> were also measured during the test program.

Source testing was performed by Russ P. Logan and Jerry D. Grissom of Total Air Analysis.

## **3.0 Equipment and Process Description**

The Flare System consists of numerous collection wells pulling landfill gas into the flare. Following is a description of the subject landfill gas collection and flare system:

1. Landfill gas extraction wells.
2. Condensate water separator, vertical, 30 inches in diameter by five feet high, stainless steel construction, used to remove and collect condensate (water vapor) from incoming landfill gas.
3. Condensate water holding tank, 1,050 gallon capacity, five feet one inch in diameter by eight feet one inch high. Condensate water collected in the tank is disposed of by injection into the flare. A 5 hp air compressor drives the pneumatic pump needed to send the condensate water from the tank to the flare.
4. Gas blower, 500 scfm capacity, used to draw gas from the collection system and deliver it to the flare burner manifold. A standby blower is provided in case of failure of the primary blower.
5. Gas flow measurement station, used to measure and record gas flow rates.
6. Propane system, two propane tanks equipped with regulators set at different pressures. The pressure in the piping indicates which tank is in operation (primary/high pressure or secondary/low pressure).
7. Enclosed ground flare, rated at 13.5 MMBtu/hour, manufactured by Perennial Energy, Inc., model EF4-10.50-14303233-Z-00-10 (or equivalent), used for the continuous flaring of landfill gas. The flare is approximately six feet in diameter by 24 feet high, equipped with an automatic ignition system, three thermocouples, a propane fired pilot, an automatic temperature control system, a flame arrester, and a safety shutdown system.



# City of Santa Maria Landfill Gas Flare

Sample  
Port

55" I.D.

28.5"

~>30'

Inlet Sample  
Port

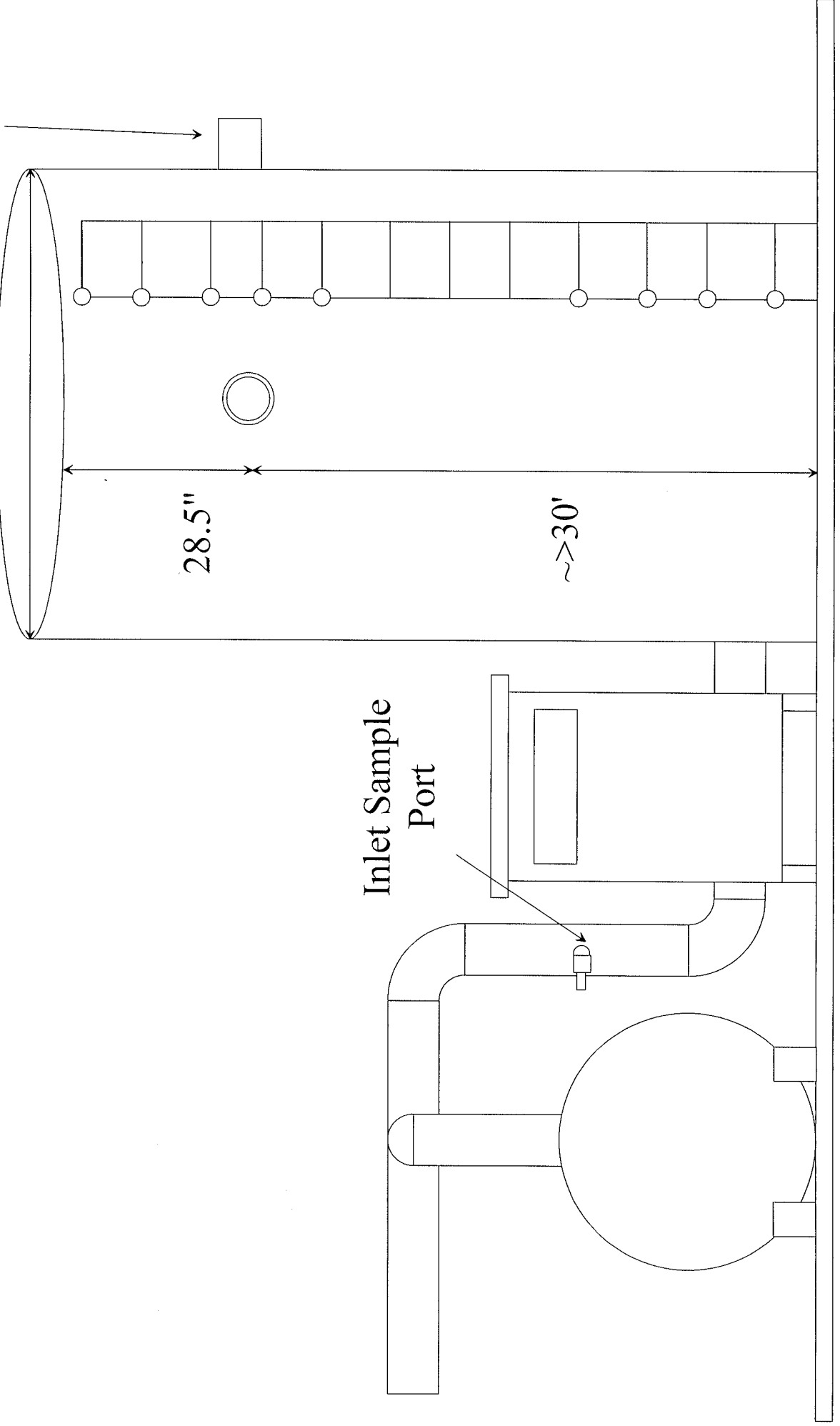

#### 4.0 Rule/Compliance Requirements

The objective of the source testing was to determine concentrations and emission rates of selected compounds from the exhaust of the flare. **Table 1** summarizes the target compounds and sampling performed. **Table 2** summarizes the run times and dates of each test method.

**Table 1 – Summary of Target Compounds, Test Methods, and Sampling Duration**

Toxic Compounds		Test Method	Number of Tests	Sampling Duration
Formaldehyde		CARB 430	Three	Two hours
Total Chrome		CARB 436	Three	Two hours
Nickel		CARB 436	Three	Two hours
Manganese		CARB 436	Three	Two hours
Arsenic		CARB 436	Three	Two hours
Cadmium		CARB 436	Three	Two hours
Hexavalent Chrome		CARB 425	Three	Two hours
Hydrogen Chloride (HCL)		EPA 26	Three	Two hours
Hydrogen Fluoride (HF)		EPA 26	Three	Two hours
Acrylonitrile		EPA 18	Three	Two hours
1, 4 – Dioxane		EPA 18	Three	Two hours
PAHs	Naththalene	CARB 429	Three	Two hours
	Benzo(b)fluoranthene	CARB 429	Three	Two hours
	Benzo(k)fluoranthene	CARB 429	Three	Two hours
	Benzo(a)pyrene	CARB 429	Three	Two hours
	Indeno(1,2,3-cd)pyrene	CARB 429	Three	Two hours
	Dibenz(a,h)anthracene	CARB 429	Three	Two hours

**Table 2 – Summary of Sampling Time**

Compounds	Run #	Sample Date	Sampling Time
PAHs	1	Sept 9, 2010	14:30 – 16:35
Multiple Metals	2	Sept 9, 2010	18:50 -20:55
VOCs	3	Sept 10, 2010	15:25-17:30
Formaldehyde	4	Sept 10, 2010	19:50-21:55
Hexavalent Chrome	5	Sept 11, 2010	10:30-12:35
Acids	6	Sept 11, 2010	14:00-16:05

Note: NO<sub>x</sub>/CO/CO<sub>2</sub>/O<sub>2</sub> were continuously recorded during all six runs to show any changes in Flare operation.

**5.0 Test Description**

The Flare was tested under normal operating conditions. Process operating data (Flare temp, and fuel usage) was logged continuously throughout the test program and is shown in Appendix I – Facility Flare process data. Table 3 shows the average operating data during each run.

**Table 3 – Process Conditions**

Test date	Run #	Flare Temp	Fuel Usage
Sept 9, 2010	1	1438°F	239 SCFM
Sept 9, 2010	2	1438°F	235 SCFM
Sept 10, 2010	3	1438°F	225 SCFM
Sept 10, 2010	4	1439°F	250 SCFM
Sept 11, 2010	5	1438°F	251 SCFM
Sept 11, 2010	6	1438°F	233 SCFM

## 6.0 Sampling and Analytical Procedures

### 6.1 CARB Method 100 - Continuous Gaseous Emissions Sampling

A continuous gas sample was extracted from the stack through a coarse filter, heated stainless steel probe, and Teflon line attached to our iced sample conditioner followed by an electronic thermal cooler. The sample was then drawn via 3/8" Teflon line into the climate controlled Mobile Emission Laboratory and delivered to the analyzers through the manifold, dedicated valves, and pressure indicators.

Prior to beginning of testing, a system leak check, calibration error, and system bias check was performed. The leak check was accomplished by plugging the probe tip and drawing at least 20" Hg vacuum on the entire sampling system. When all flow meters indicate 0.0 SCFH flow, the system was proven to be free of any leaks.

The calibration error check was performed as follows: After zeroing all analyzers, EPA Report No. 1 gases were used to calibrate each analyzer within 80-100% of full scale of the selected range. Then a 40%-60% of the selected range gas was introduced to each analyzer. Additionally, a system bias calibration check is performed by passing EPA Report I zero and calibration gases through the entire sampling system using a three-way valve located at the probe tip. Sampling system bias checks are determined by comparing the external calibration values to that of the values when introduced directly to each instrument.

To verify the latest sample conditioning requirements for CARB Method 100.1, two type-k thermocouples were used to measure the exit temperatures from the sample conditioner and electronic chiller. The gas temperature at the outlet of the sample conditioner was kept below 60°F and the temperature from the chiller will maintain below 37°F. A NO<sub>2</sub> conversion efficiency (CE) test was performed as required by CARB on-site. Additionally, a 3-point divider linearity check was performed on-site with the gas divider. The specifications of the instruments used for the CARB 100.1 sampling are as follows:

<i><b>NO<sub>x</sub> CHEMILUMINESCENT ANALYZER, California Analytical Instruments (CAI)</b></i>	<i><b>MODEL 600 Serial No. U09024</b></i>
Ranges	0-3 ppm, up to 0-3,000 ppm
Output	0-10V / 4-20mA
Linearity	Better than 0.5% of full scale
Operating Temperature	5-40 °C
Converter (Vitreous Carbon) Temp	205 °C > 95% efficiency
Detection Limit	0.1 ppm
Response Time (0%-90%)	Typically < 2 Seconds in NO <sub>x</sub> mode
Repeatability	Better than 0.5% of full scale
Zero + Spam Drift	< 1% full scale
Sample Flow rate	Typically 1.5-2.5 LPM

# MANIFOLD SCHEMATIC

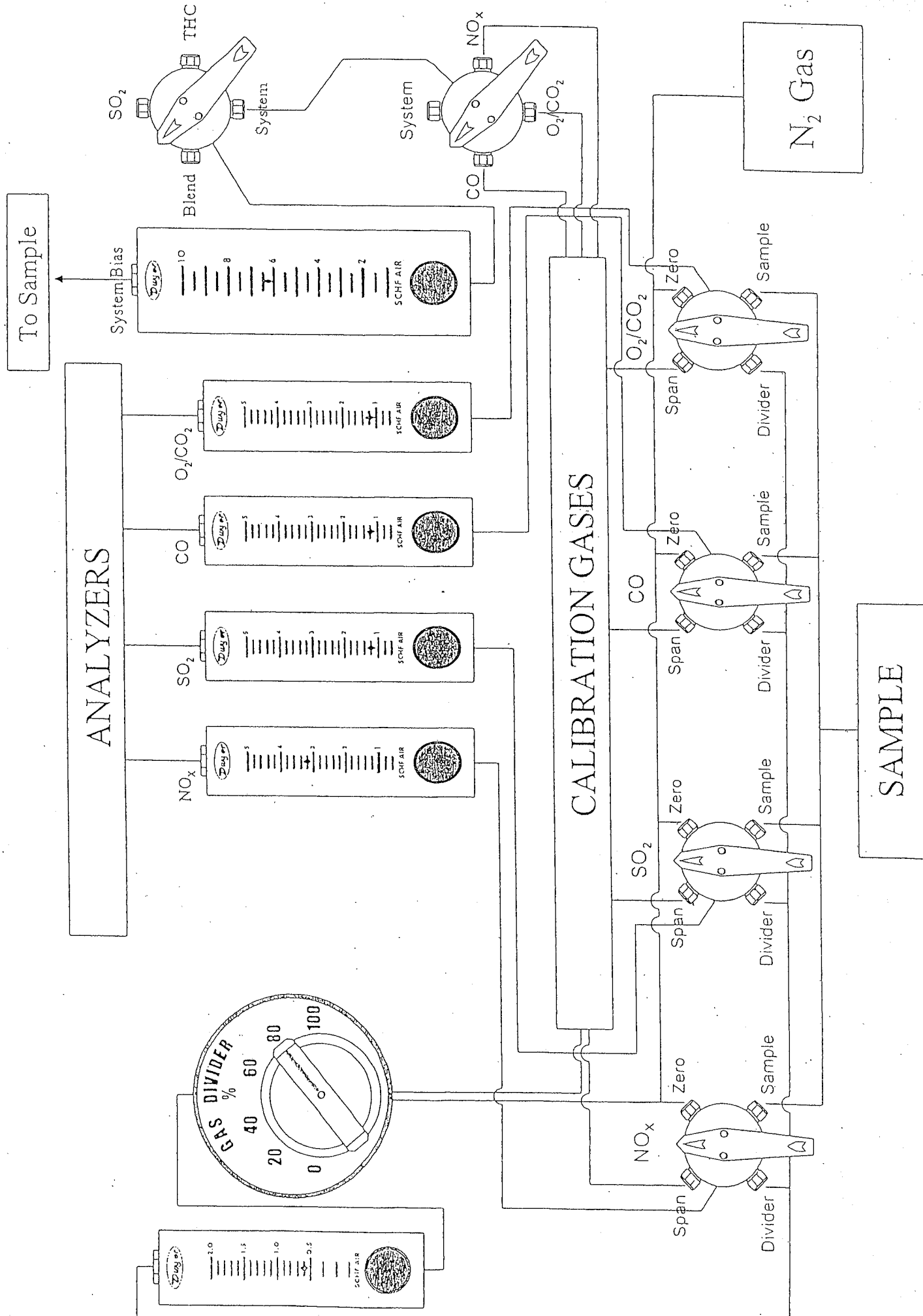

<b><i>CO<sub>2</sub> ANALYZER, NON-DISPERSIVE INFRARED (NDIR)</i></b>	<b><i>SERVOMEX, MODEL 1400 B Serial No. 4363</i></b>
Ranges	0%-25%, single range
Output	0-1 V or 4-20 mA (isolated)
Linearity	+/- 1% of full scale
Operating Temperature	0 to 40°C
Detection Limit	0.1%
Response Time (0%-90%)	<30 Seconds
Accuracy	+/- 1% of full scale
Repeatability	+/- 1% of full scale
Drift	<1% of full scale per 24 hours
Sample Flow Rate	0.5 – 1 li./min

<b><i>O<sub>2</sub> ANALYZER, PARAMAGNETIC</i></b>	<b><i>SERVOMEX, MODEL 1400</i></b>
Ranges	Selectable from 0%-1% up to 0%-100%
Output	0-1 V
Linearity	+/- 1% of full scale
Operating Temperature	5 to 50°C
Detection Limit	0.1%
Response Time (0%-90%)	<15 Seconds
Accuracy	+/- 0.1%
Repeatability	+/- 0.1%
Drift	<0.1%
Sample Flow Rate	1-2 li./min

<b><i>CO, California Analytical Instruments (CAI) Non-Dispersive Infrared (NDIR)</i></b>	<b><i>Model 602 Serial No. 512011</i></b>
Ranges	0-25 ppm, 0-10,000 ppm
Output	0-10V
Linearity	+/- 0.5%
Operating Temperature	5-45°C
Detection Limit	1.0 ppm
Response Time (0%-90%)	20 seconds
Accuracy	+/- 0.1%
Repeatability	< 1.0% of full scale
Noise	< 1.0% of full scale
Drift	< +/- 1% of full scale per 24 hours
Sample Flow Rate	0.5 – 2.0 l pm

<b>THERMAL ELECTRIC SAMPLE COOLER</b>	<b>BALDWIN TESTER CHOICE MODEL NO. 5210</b>
Maximum Inlet Gas Temperature	+ 450 °F
Maximum Inlet Gas Dewpoint	+138 °F
Maximum Inlet Water Concentration	30% by volume
Maximum Ambient Temperature	+104 °F
Maximum Inlet Pressure	50 psig
Maximum Sample Gas Flow Rate	8 li/min (12.9 scfh)
Ambient Temperature Range	+40 to 104 °F
Outlet Sample Gas Dewpoint	<36 °F +/- 1 °F
Power	740 Watts
Water Removal	Peristaltic Drain Pump

<b>STRIP CHART RECORDER</b>	<b>YOKOGAWA MODEL HR 2400</b>
Scan Cycle Time	1-60 Seconds
Scanning Rate	60 ms/Channel
Input Bias	Less than 10mA
Chart Speed	1-15,000 mm/hr
Maximum Allowable Input Voltage	60 VDC
Recording Accuracy	+/- 0.1 of effective range
Chart Speed Accuracy	+/- 0.1% recordings greater than 1 m
Data Acquisition System	Varilink Digital Software

<b>MOBILE EMISSIONS LABORATORY</b>	<b>GMC 15' BOX VAN</b>
Insulation	Fully Insulated
Air Conditioning	1 Full-size Coleman Air Conditioner
Computer	IBM Compatible System

### **Calculations**

Corrected Concentrations = (Raw Conc. - Avg. Zero) x Cal. Gas Value/(Avg. Span - Avg. Zero)

ppm NO<sub>x</sub> @ 15% O<sub>2</sub> = Corrected Concentrations x 5.95/(20.95 - %O<sub>2</sub> drift corr.)

LB/hr, Emission Rate = Corrected Concentrations x 1.558 x 10<sup>-7</sup> @ 68 °F x DSCFM x M<sub>d</sub>

M<sub>d</sub> = Dry Molecular Weight of NO<sub>x</sub> and CO= 46 and 28

NO<sub>2</sub> Conversion Efficiency, % CE = (D<sub>3</sub> - D<sub>2</sub>/D<sub>1</sub>) x 100

Where: D<sub>1</sub> = ppmv, NO<sub>2</sub> (cylinder)

D<sub>2</sub> = ppmv, reading NO mode

D<sub>3</sub> = ppmv, NO<sub>2</sub>, NO<sub>x</sub> mode

# Total Air Analysis, Inc. Sampling System

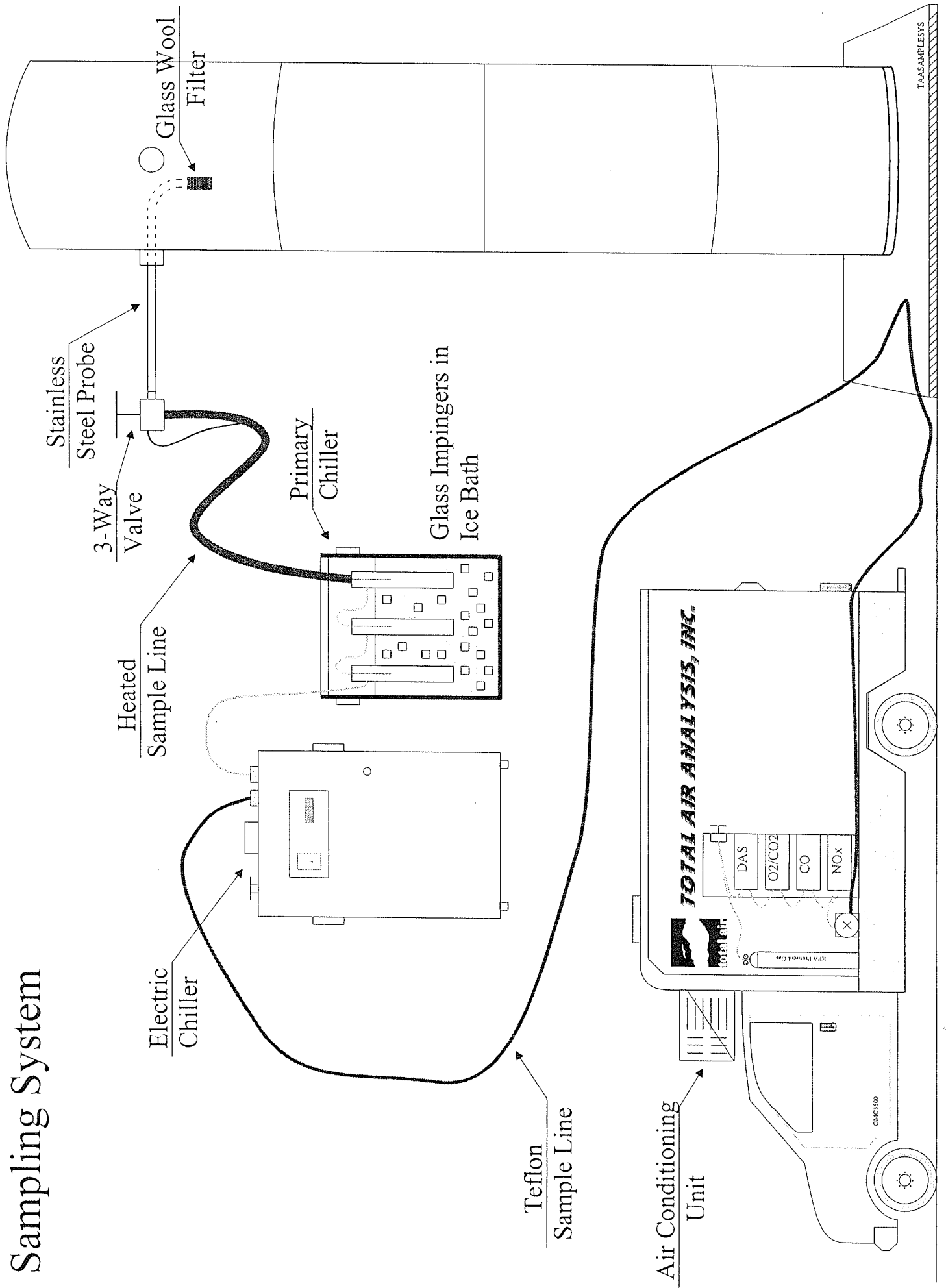



## **6.2 CARB Method 425 - Hexavalent Chromium Emissions**

This method determines Hexavalent chromium emission. The sampling equipment that came in contact with the sample was quartz/glass, glass, or Teflon and was put to an extremely stringent cleaning procedure and soaked in 1:1 Nitric Acid solution for at least six hours. A sample of stack gasses was withdrawn isokinetically from the source through the sample train. Hexavalent chromium was collected in impingers containing 0.1 NaOH and on the heated filter. The impingers were contained in an ice bath to maintain a sampled gas temperature of approximately 60°F. Samples were analyzed by Quantum Analytical for Hexavalent chromium using Ion Chromatograph (IC).

## **6.3 CARB Method 429 - Determination of Polycyclic Aromatic Hydrocarbons (PAH) in Emissions from Stationary Sources**

This method applies to the determination of nineteen polycyclic aromatic hydrocarbons (PAH) in emissions from stationary sources. Particulates and gaseous phase PAH were extracted from the stack and collected on XAD-2 resin and impingers. The analytical method was isotope dilution mass spectrometry combined with high-resolution gas chromatography.

The sampling train consisted of nozzle, probe, heated particulate filter, condenser, and sorbent module followed by three impingers and a silica gel drying cartridge.

The sample transfer line used was Teflon (1/4 in. O.D. x 1/32 in. wall) with connecting fittings that were capable of forming leak-free, vacuum tight connections without using sealing greases.

The sorbent module used was made of glass with o-ring fittings. A coil-type condenser, with circulating cold water, preceded the vertical resin trap. Gas entering the sorbent module was cooled to 20°C (68°F) or less. The gas temperature was monitored by a thermocouple placed either at the inlet or exit of the sorbent trap. The sorbent bed was firmly packed and secured in place to prevent settling or channeling during sample collection. Ground glass caps (or equivalent) were used to seal the sorbent-filled trap both prior to and following sampling. All sorbent modules were maintained in the vertical position during sampling.

Four impingers in series with ground glass fittings able to form leak-free, vacuum tight seals without sealant greases were connected. The impingers are Greenburg-Smith design modified by replacing the tip with a 1.3 cm (1/2 in.) I.D. glass tube extending to 1.3 cm (1/2 in.) from the bottom of the flask.

The first and second impingers contained 100 mL of 3 mM sodium bicarbonate ( $\text{NaHCO}_3$ ) and 2.4 mM sodium carbonate ( $\text{Na}_2\text{CO}_3$ ). This was intended to neutralize any acids that might form in the impingers. The third impinger was empty. Silica gel was added to the fourth impinger.

## CARB Method 425 – Hexavalent Chrome

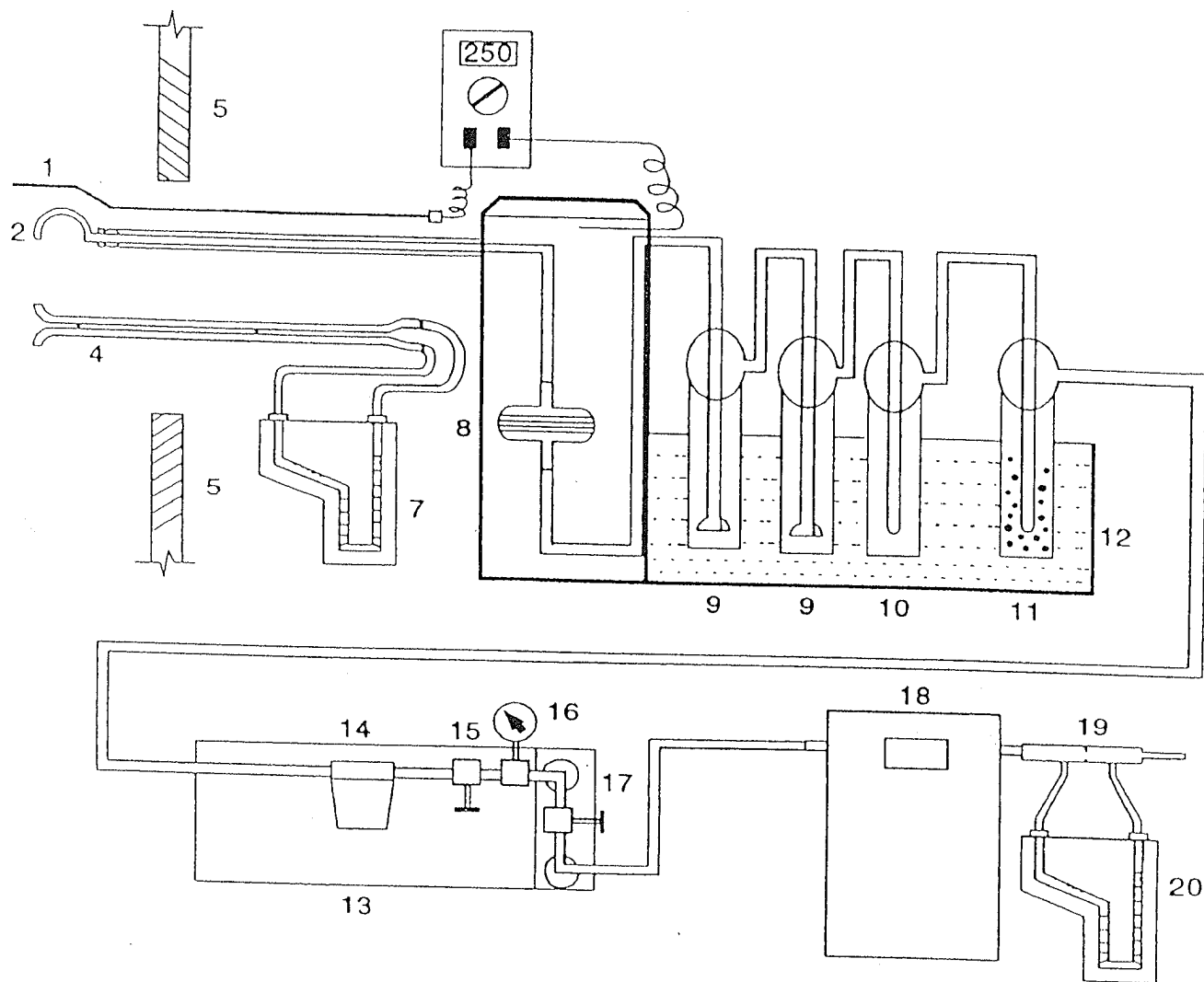

- |  |  |
|--|--|
| <ol style="list-style-type: none"> <li>1. Temperature Sensor</li> <li>2. Nozzle</li> <li>3. Glass lined Stainless Steel Probe-Heated</li> <li>4. S-type Pitot Tube</li> <li>5. Stack Wall</li> <li>6. Temperature Sensor Meter</li> <li>7. Pitot Tube Inclined Manometer</li> <li>8. Heated Box with Filter</li> <li>9. Impinger with 100 ml</li> <li>10. Empty Bubbler</li> </ol> | <ol style="list-style-type: none"> <li>11. Bubbler with Silica Gel</li> <li>12. Ice Bath</li> <li>13. Sealed Pump (Leak Free)</li> <li>14. Filter for Pump</li> <li>15. Metering Valve</li> <li>16. Vacuum Gauge</li> <li>17. By-pass Valve</li> <li>18. Temperature Compensated Dry Gas Meter</li> <li>19. Orifice</li> <li>20. Crifice Inclined Manometer</li> </ol> |
|--|--|

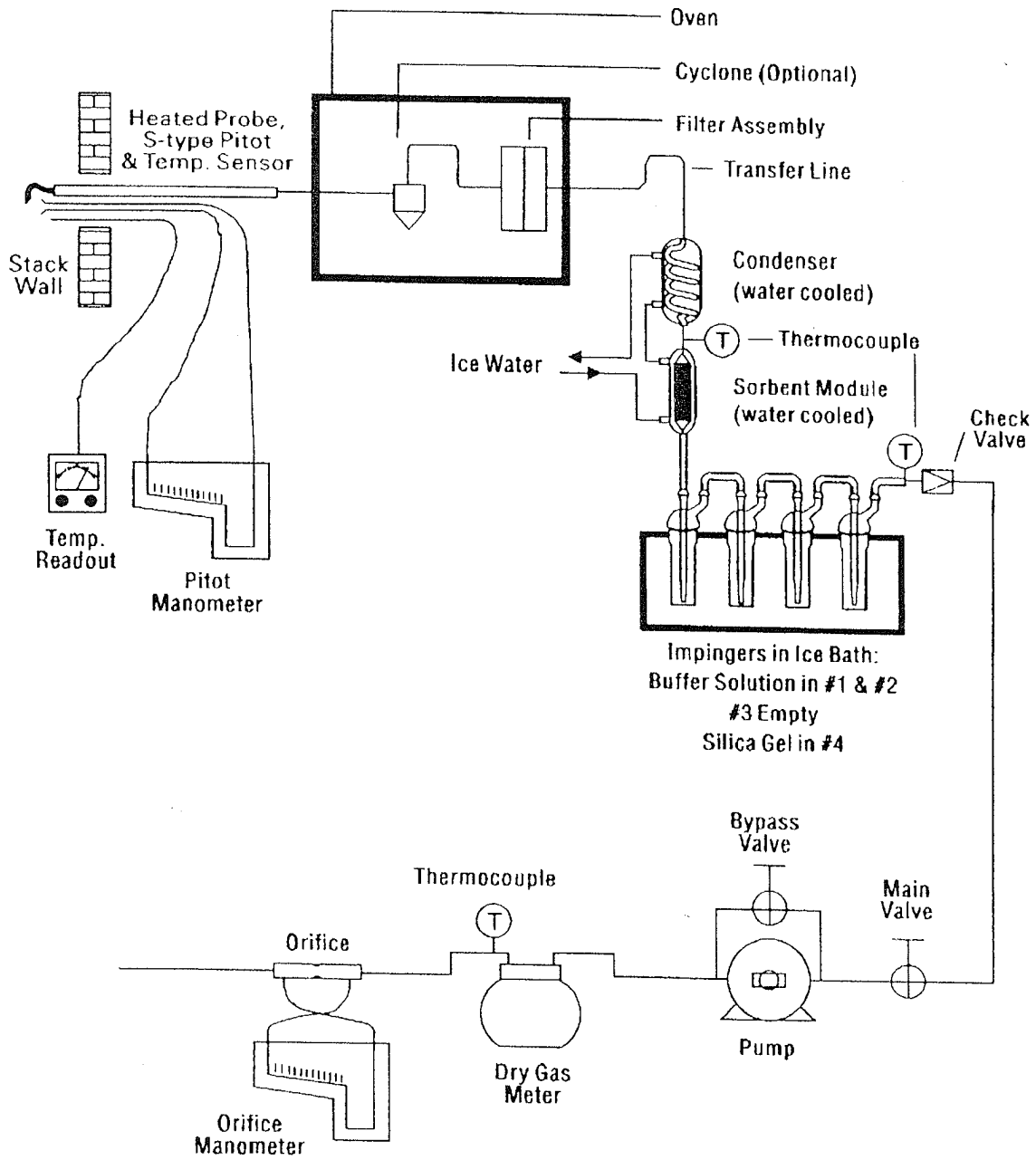

Figure 2  
PAH Sampling Train

Vista Analytical Laboratory, in El Dorado Hills, California, prepared the XAD resin traps and conducted all analytical procedures in accordance with CARB method 429 for PAHs. Front half (probe rinse and filter) and back half (condenser rinse and resin trap) samples were combined and analyzed using high resolution GC/MS. As part of the method QA/QC, all of the resin traps were pre-spiked with isotopically labeled PAH's, and a sampling train blank (consisting of all sampling materials and reagents) were prepared and submitted along with the samples for identical analysis.

#### **6.4 CARB Method 430 - Determination of Formaldehyde Emissions from Stationary Sources**

Formaldehyde was sampled and analyzed using CARB Method 430 by Air Toxics, Ltd. located in Folsom, California. The method is based on the use of HPLC.

Gaseous emissions were drawn through a Teflon sample line and two impingers in series, each impinger containing an aqueous acidic solution of 2,4-dinitrophenyl-hydrazine (DNPH). The sample line was rinsed with another aliquot of the same solution. An aldehyde reacts with DNPH by nucleophilic addition on the carbonyl followed by 1,2-elimination of water and the formation of a 2,4-dinitrophenylhydrazone. Acid is required to promote protonation of the carbonyl because DNPH is a weak nucleophile.

After organic solvent extraction, the sample was analyzed using reverse phase HPLC with an UV absorption detector. Impingers were analyzed separately.

Formaldehyde in the sample was identified and quantified by comparison of retention times and area counts of sample extracts with those of standards.

Sampling was performed at a constant rate of approximately 1.0 liters per minute for 20 minutes, using a low volume sampling pump. The sampling rate was determined before and after each test run using a mini-flow meter. As part of the method QA/QC, sampling material blanks (reagents) were submitted along with the samples for analysis. The DNPH solution was prepared in the laboratory 48 hours prior to sampling.

#### **6.5 CARB Method 436 - Multiple Metals Emission Determination**

The sampling equipment that came in contact with the sample was glass or Teflon and put to an extremely stringent cleaning procedure. All sampling equipment was pre-washed with hot soapy water, soaked in 1:1 HNO<sub>3</sub> for at least 6 hours, rinsed with Type II water, and finally allowed to air-dry then sealed with TFE tape.

A series of preliminary measurements were conducted prior to conducting the test. CARB Methods 1, 2 and 3 were performed to determine location and number of traverse points. Percent moisture was estimated and the nozzle size was determined for isokinetic sampling.

The sampling train was prepared on-site in our mobile emissions laboratory. The first two impingers were charged with 100 ml of 5% HNO<sub>3</sub>/10% H<sub>2</sub>O<sub>2</sub> solution, the third impinger was empty, and the fourth impinger contained approximately 300 gram of silica gel. The quartz

# CARB Method 430

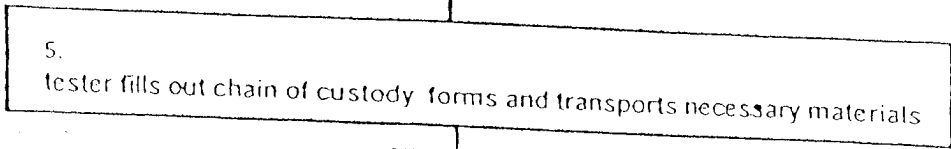
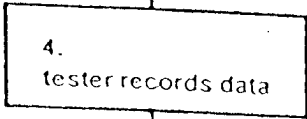
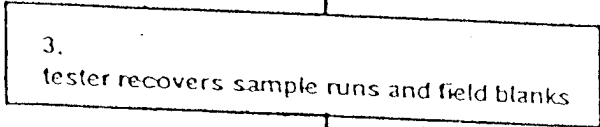
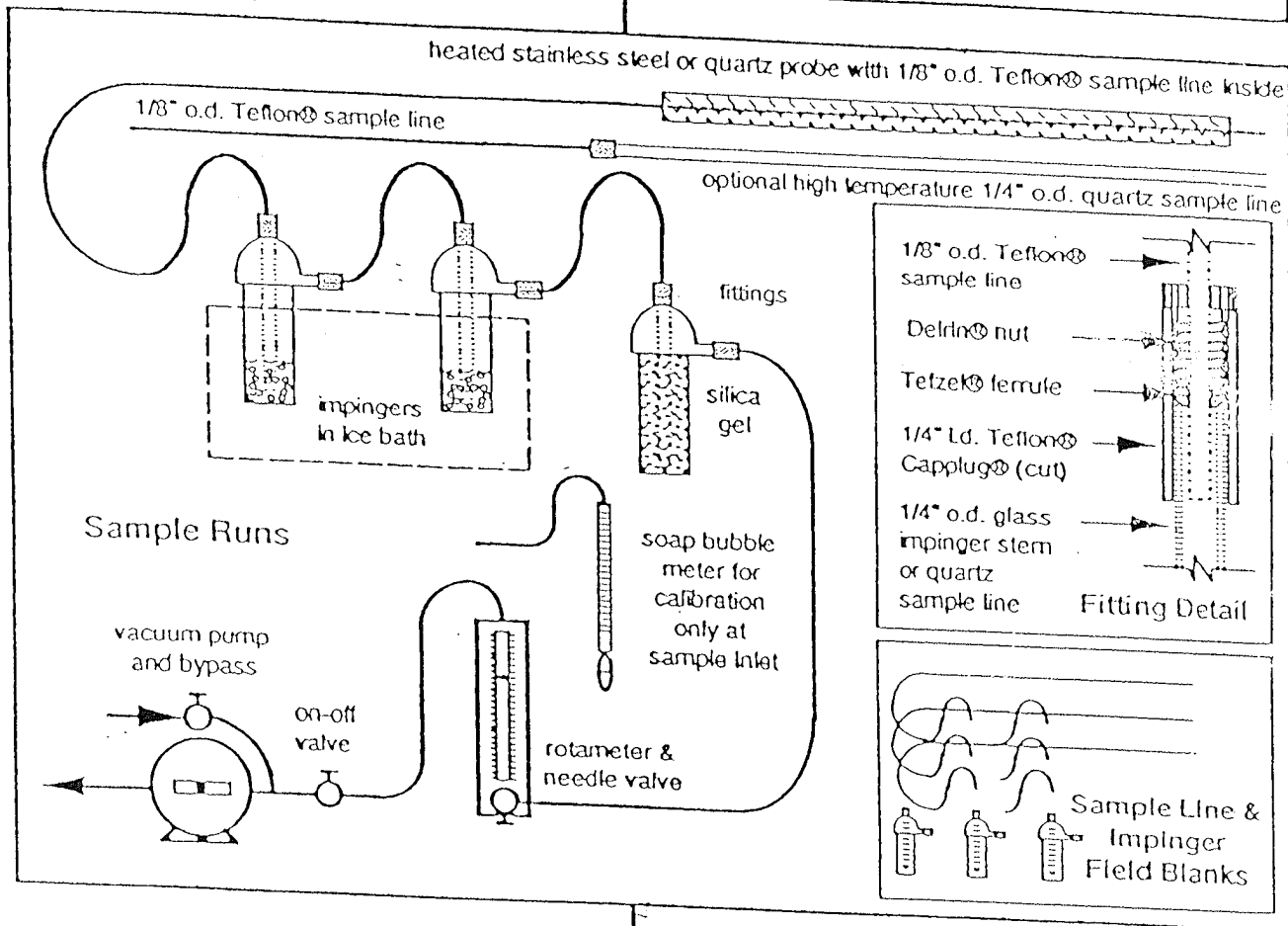
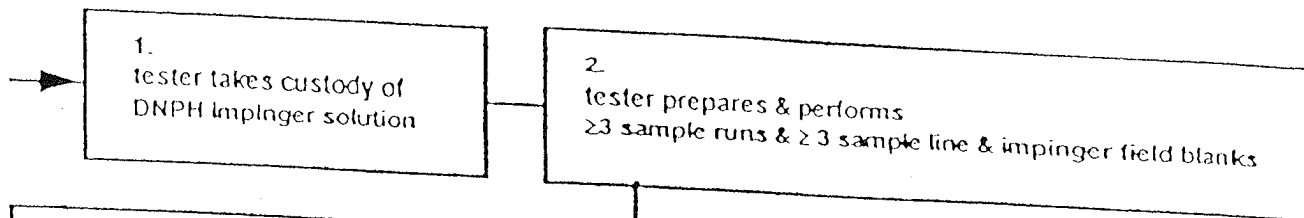

# CARB Method 436

## Multiple Metals

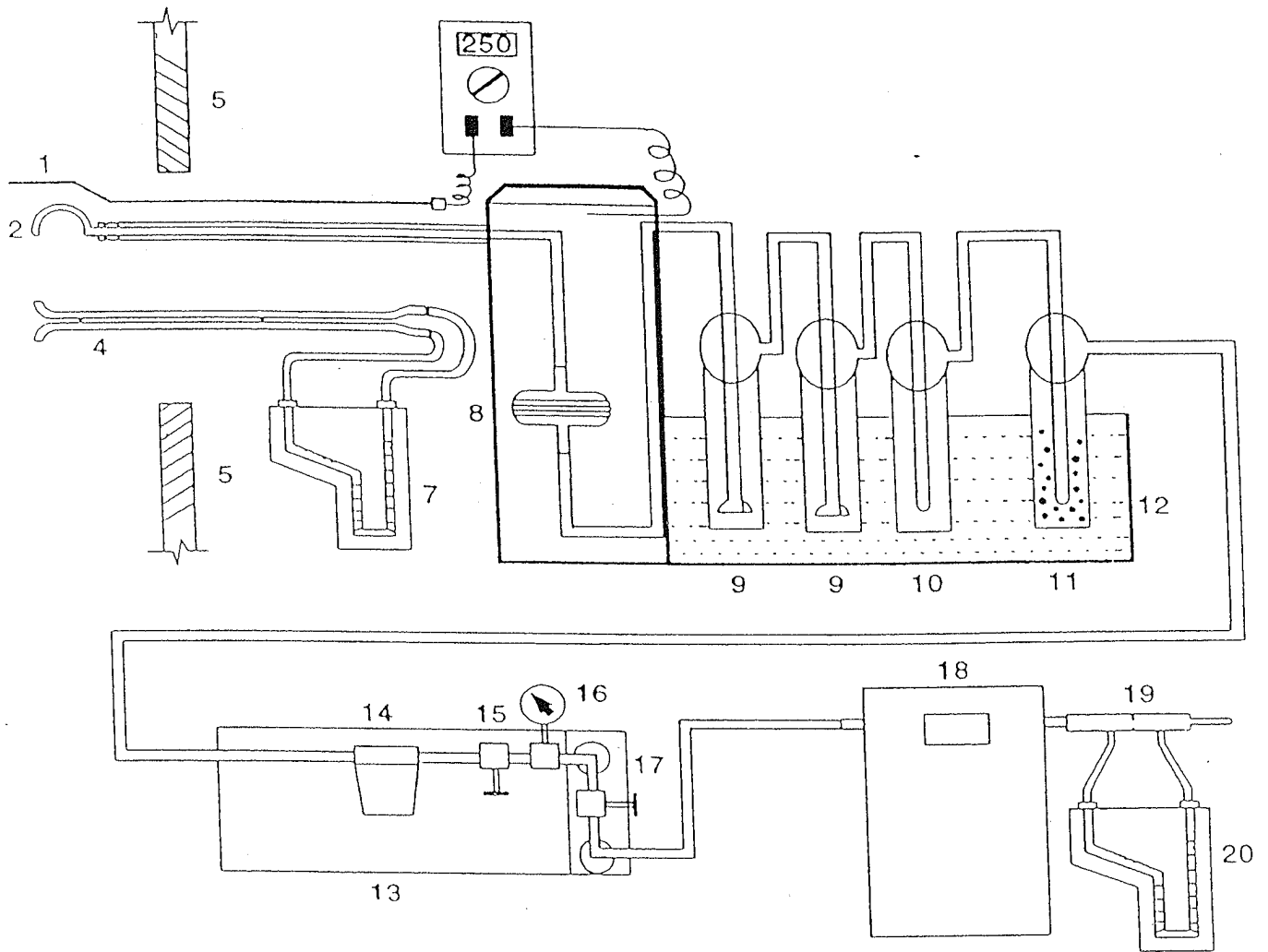

- |  |   |
|--|---|
| 1. Temperature Sensor  | 11. Bubbler with Silica Gel               |
| 2. Nozzle  | 12. Ice Bath                              |
| 3. Glass lined Stainless Steel Probe-Heated                                    | 13. Sealed Pump (Leak Free)               |
| 4. S-type Pitot Tube   | 14. Filter for Pump                       |
| 5. Stack Wall  | 15. Metering Valve                        |
| 6. Temperature Sensor Meter  | 16. Vacuum Gauge                          |
| 7. Pitot Tube Inclined Manometer   | 17. By-pass Valve                         |
| 8. Heated Box with Filter  | 18. Temperature Compensated Dry Gas Meter |
| 9. Impinger with 100 ml 5% HNO <sub>3</sub> /10% H <sub>2</sub> O <sub>2</sub> | 19. Orifice                               |
| 10. Empty Bubbler  | 20. Crifice Inclined Manometer            |

fiber filter was placed in the filter holder. The sampling apparatus was sealed and transported to the sampling locations where it was assembled and leak checked at 15-in. mercury vacuum.

The test was started when the nozzle is positioned into the gas flow, the vacuum pump started and the dH adjusted to obtain an isokinetic-sampling rate. A complete traverse was performed while sampling at seven and a half (7.5) minutes per sample point. Upon completion of the sampling run, the apparatus was leak checked at a vacuum greater than the highest observed vacuum during the test. The probe and the filter was cooled off and removed from the train and sealed with Teflon tape, and then the entire train component was transported to the mobile laboratory for recovery.

The filter and the loose particulate was carefully removed from the filter holder with TFE coated tweezers and placed into a labeled glass petri dish. The nozzle and probe was rinsed and brushed at least three times using 0.1 N HNO<sub>3</sub> and placed into a sample bottle labeled "Probe and Nozzle rinse". The impingers' solution was measured and placed into a sample bottle labeled "Impinger Catch". A 200-ml of the impinger solution, rinsing solution and a filter was placed in sample bottles and a petri dish and labeled as "Reagent Blank." The samples were transported to Cal Tech Environmental Laboratories for analysis, where the filter were combined with the "Probe and Nozzle rinse" and analyzed.

The samples and the blanks were analyzed for multiple metals using inductively coupled plasma (ICP).

#### **6.6 EPA Method 18 - Measurement of Gaseous Organic Emissions by Gas Chromatography**

Acrylonitrile and 1,4-Dioxane were sampled using EPA Method 18 – Measurement of Gaseous Organic Emissions.

Columbia Analytical Services analyzed the samples by gas chromatograph/mass spectrometer (GC/MS).

The organic components of a gas mixture are separated by gas chromatography and individually quantified by flame ionization, photoionization, electron capture, or other appropriate detection principles. The retention times of each separated component are compared with those of known compounds under identical conditions.

Tedlar sampling bags were used to sample the gas stream. Tedlar bags are a convenient and accurate means of collecting and measuring the concentration of chemicals in a gas stream. Tedlar film resists gas permeation both into and out of the bag. This assures sample integrity and valid data for analysis for most applications. A vacuum chamber (lung sampler) was used to allow the direct filling of the tedlar bag using negative pressure provided by the sampling pump. This eliminated the risk of contamination of the pump or the sample. Sample analyses were performed within 24 hours of collection.

### **6.7 EPA Method 19 - Volume Flow Determination by Fuel**

A new three-liter Tedlar bag fitted with polypropylene valves or the equivalent was used for sample transportation and storage. The bag was leak checked and purged with ultra pure nitrogen and stored in a safe area. Prior to sampling, the bag was conditioned to the fuel gas by filling and emptying the bags at least three times before the actual sample was taken.

The fuel sample was collected in a dark container to prevent the sun light from modifying the sample metrics.

The sample was analyzed for heat content (BTU) using ASTM Method 3588, and the ultimate analysis for the determination of Hydrogen, Carbon, Sulfur, Nitrogen, Oxygen, and Water from fuel by percent weight.

#### **Calculations:**

$$\text{Stack Gas Flow rate} = \text{Fuel Flow rate} \times \text{Heat Content} \times \text{F Factor} \times (20.9/(20.9-\text{O}_2))$$

### **6.8 EPA Method 26 - Hydrochloric Acid (HCL) Emissions Determination**

A series of preliminary measurements were conducted prior to conducting the test. CARB Methods 1, 2 and 3 were performed to determine location and number of traverse points.

The sampling train was prepared on-site in our mobile emissions laboratory. The first two impingers were charged with 100 ml of 0.1 N H<sub>2</sub>SO<sub>4</sub>, the third impinger was empty, and the fourth impinger contained approximately 300 grams of silica gel. The probe was brushed and rinsed with DI H<sub>2</sub>O. The heated filter was placed in the filter holder and connected to the sample train. The sampling apparatus was sealed and transported to the sampling location where it was assembled and leak checked.

The test will started and the dH was set to approximately 1.5 or a 0.7 cfm sampling rate. Each sample was taken for 120 minutes.

Upon completion of the sampling run, the apparatus was leak checked at a vacuum greater than the highest observed vacuum during the test. The probe and filter was removed from the train and sealed, then transported to the mobile laboratory for recovery.

The impinger's solution was measured and recovered. The samples was then transported to Quantum Analytical Laboratory for HCL analysis.

### **7.0 Quality Assurance and Quality Control**

Total Air Analysis applies stringent quality control and quality assurance procedures to ensure the validity of measurements for all projects. Total Air Analysis QA/QC procedures are documented in detailed Quality Assurance Project Plans similar to those used by the EPA, CARB, SCAQMD, and SDAPCD.



REFERENCE METHOD (RM)  
SAMPLING AND LABORATORY ANALYTICAL PROCEDURES

*EPA Method 26  
Equipment/Setup*

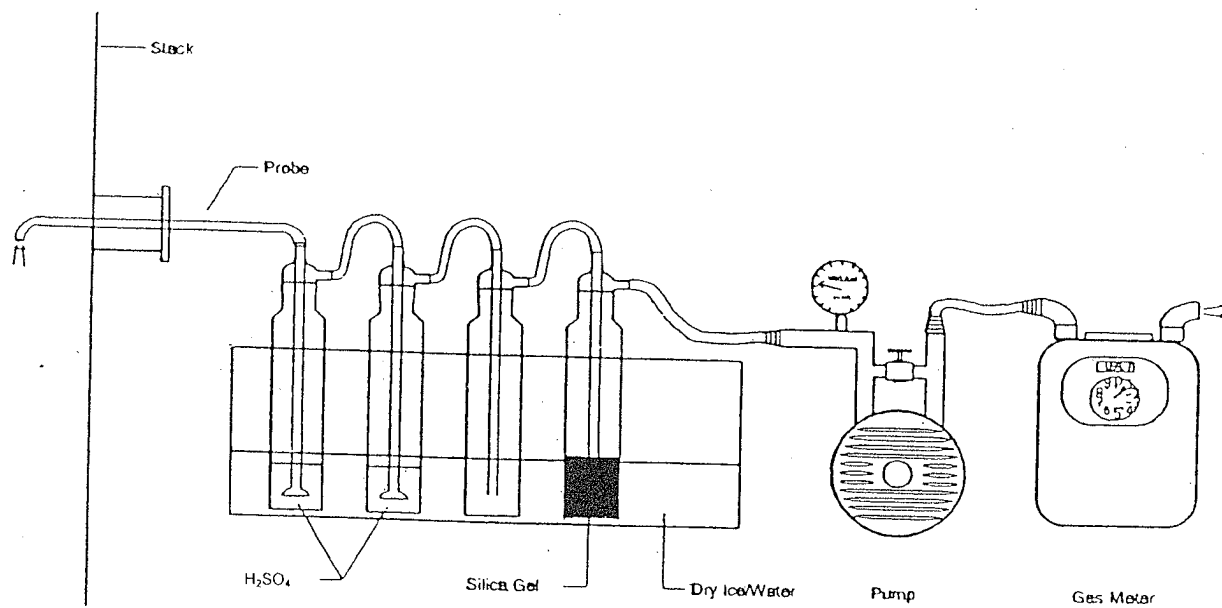

## 7.1 QA/QC Overview

Generally, Total Air Analysis QA/QC procedures follow guidelines in *Quality Assurance Handbook for Air Pollution Measurement Systems*, Volumes I through III. These procedures outline pretest preparation and calibrations of sampling equipment, post-test sample handling, and post-test calibrations. Standardized, written procedures, calculator programs, and spreadsheets are used for test planning, pre-surveys, equipment checklists, preliminary calculations, data and sample collection, sample tracking, data analysis, and reporting. Pre-test preparations and maintenance include organization of the following equipment:

- Calibrated pitots, balances, TCs, control boxes, sampling train specific for moisture, sample probes suitable for type of sampling to be done, and support equipment such as tools, safety gear, radios, and spares.

Test procedures follow applicable SCAQMD or other approved test methods. For non-continuous sampling systems (moisture train, etc.), these procedures specify the following:

- Pre-test and post-test leak checks on both pitot connections and moisture trains.
- Maintenance of pitot tube in a horizontal attitude by employment of special rail systems or jigs.
- Proper configuration of moisture train.
- Sample and velocity traverses, number and location of sampling points, check for cyclonic flow; stratification checks.
- Minimum sample time and volume for moisture determination.
- Required temperature limitations.
- Other test method-specific procedures.

## 7.2 QA/QC Equipment Calibration Procedures

Table 4 contains the specific QA/QC equipment calibration requirements that are strictly followed by Total Air Analysis personnel.

**Table 4**  
**Quality Assurance / Quality Control Calibration Table**

<b>Component</b>	<b>Frequency of Calibration</b>	<b>Requirements of Calibration</b>	<b>Limits of Calibration</b>
Pitots	Prior to each source testing program and semiannually	Visual inspection and measurements of angles and distances	$C_p$ is assumed to be 0.84 if all measurements are within specification
Stack Temperature and Sensors, Thermocouple, and Potentiometer System	Bimonthly	Ice water, boiling water, and boiling oil	$\pm 1.5\%$ deviation from referenced mercury in-glass thermometer
Barometer	Semiannual	Comparison to mercury in-glass barometer	$\pm 0.1$ inches from deviation from referenced mercury in-glass thermometer
Reference Wet Test Meter	Semiannual	Calibrated against an NBS traceable orifice or NBS laminar flow element	$Y_{rm} = 1.00 \pm 0.05$
Analyzer Linearity Checks	Quarterly	6 points – 0%, 20%, 40%, 60%, 80%, and 100% of full scale	Analyzer linearity = $\pm 2\%$ from actual value
Gas Divider Verification	Quarterly	6 point linearity check followed by internal calibration	Gas divider = $\pm 2\%$ from verification cylinder value
NO <sub>2</sub> Conversion Efficiency	Project Monthly	NO <sub>2</sub> calibration gas direct to NO <sub>x</sub> analyzer	Greater than 90% conversion efficiency

## **Appendix A**

### ***CARB Method 100 - NO<sub>x</sub>, CO, O<sub>2</sub>, CO<sub>2</sub>* Calculation Spreadsheets, DAS, and Strip Charts**

## Calibration Error, Bias, Drift & Drift-Corrected Concentrations

Run Number: 1

CEM Operator: RPL

**Facility:** Santa Maria Landfill      **Start Time:** 14:42  
**Source:** Flare                              **End Time:** 16:09  
**Load:** Normal  
**Start Date:** 9/9/2010

Species		NOx	CO	O2	CO2
Concentration Unit		%, dry	%, dry	ppmv, dry	ppmv, dry
High-Range Gas Fraction of Span		0.83	0.87	0.89	0.73
Span		50	100	25	25
Span Gas Concentration, Cma	HIGH	41.60	87.40	22.21	18.35
	MID	23.64	34.96	9.06	9.117
	ZERO	0.00	0.00	0.00	0.00
Initial Analyzer Calibration Check, Cai	HIGH	41.60	87.72	22.21	18.27
	MID	22.80	35.02	9.05	9.15
	ZERO	0.10	0.02	0.02	0.01
Response Time (seconds)		22.00	23.00	20.00	21.00
Initial Analyzer Calibration Error, Ei $E_i = ((C_{ma} - C_{ai})/Span) \times 100\%$	HIGH	0.00	0.32	0.00	-0.32
	MID	-1.68	0.06	-0.04	0.13
	ZERO	0.20	0.02	0.08	0.04
Initial Bias Check, Cbi  (Select Upscale Calibration Gas Closest to Stack Gas Concentration)	Upscale High (H) or Mid (M)?	M	H	M	M
	UPSCALE	22.50	85.22	9.00	9.07
	ZERO	0.00	3.42	0.05	0.02
Initial System Calibration Bias, Bi $B_i = ((C_{bi} - C_{ai})/Span) \times 100\%$	UPSCALE	-0.60	-2.50	-0.20	-0.32
	ZERO	-0.20	3.40	0.12	0.04
Final Bias Check, Cbf  (Select Upscale Calibration Gas Closest to Stack Gas Concentration)	UPSCALE	22.70	84.82	9.05	9.07
	ZERO	0.10	3.72	0.11	0.03
Final System Calibration Bias, Bf $B_f = ((C_{bf} - C_{ai})/Span) \times 100\%$	UPSCALE	-0.20	-2.90	0.00	-0.32
	ZERO	0.00	3.70	0.36	0.08
Drift Check, D $D = ((C_{bf} - C_{bi})/Span) \times 100\%$	UPSCALE	0.40	-0.40	0.20	0.00
	ZERO	0.20	0.30	0.24	0.04
Average Bias Response for zero Gas, $C_o = (C_{bi,zero} + C_{bf,zero})/2$		0.05	3.57	0.08	0.03
Average Bias Response for Upscale Gas, $C_m = (C_{bi,upscale} + C_{bf,upscale})/2$		22.60	85.02	9.03	9.07
Average Measured Concentration, Cavg		13.58	4.34	13.98	5.63
Drift Corrected Concentration, $C_{gas} = (C_{avg} - C_o) \times C_{ma} / (C_m - C_o)$		14.19	0.82	14.08	5.65
Drift Corrected Concentration, $C_{gas} = (C_{avg} - C_o) \times C_{ma} / (C_m - C_o)$ @ 15% O2		12.29	0.71	-	-

## Calibration Error, Bias, Drift & Drift-Corrected Concentrations

Run Number: 2

CEM Operator: RPL

**Facility:** Santa Maria Landfill      **Start Time:** 18:54  
**Source:** Flare      **End Time:** 20:48  
**Load:** Normal  
**Start Date:** 9/9/2010

Species		NOx	CO	O2	CO2	
Concentration Unit		%, dry	%, dry	ppmv, dry	ppmv, dry	
High-Range Gas Fraction of Span		0.83	0.87	0.89	0.73	
Span		50	100	25	25	
Span Gas Concentration, Cma	HIGH	41.60	87.40	22.21	18.35	
	MID	23.64	34.96	9.06	9.12	
	ZERO	0.00	0.00	0.00	0.00	
Drift Check from Previous Run less than 3 %?	UPSCALE	Yes	Yes	Yes	Yes	
Yes (Y) or No (N)	ZERO	Yes	Yes	Yes	Yes	
Initial Analyzer Calibration Check, Cai (Must repeat if drift from previous test >=3% Otherwise, copy calibration check from most recent cal. error determ	HIGH	41.60	87.72	22.21	18.27	
	MID	22.80	35.02	9.05	9.15	
	ZERO	0.10	0.02	0.02	0.01	
Initial Analyzer Calibration Error, Ei $E_i = ((C_{ma} - C_{ai})/Span) \times 100\%$	HIGH	0.00	0.32	0.00	-0.32	
	MID	-1.68	0.06	-0.04	0.13	
	ZERO	0.20	0.02	0.08	0.04	
Initial Bias Check, Cbi Upscale High (H) or Mid (M)? $B_i = ((C_{bi} - C_{ai})/Span) \times 100\%$	UPSCALE	22.50	85.82	9.06	9.07	
	(Select Upscale Calibration Gas Closest to Stack Gas Concentration	ZERO	0.00	2.12	0.07	0.02
	UPSCALE	-0.60	-1.90	0.04	-0.32	
Initial System Calibration Bias, Bi	ZERO	-0.20	2.10	0.20	0.04	
	UPSCALE	22.20	85.02	9.05	9.11	
Final Bias Check, Cbf (Select Upscale Calibration Gas Closest to Stack Gas Concentration	ZERO	0.20	1.62	0.08	0.05	
	UPSCALE	-1.20	-2.70	0.00	-0.16	
Final System Calibration Bias, Bf $B_f = ((C_{bf} - C_{ai})/(Span)) \times 100\%$	ZERO	0.20	1.60	0.24	0.16	
	UPSCALE	-0.60	-0.80	-0.04	0.16	
Drift Check, D $D = ((C_{bf} - C_{bi})/(Span)) \times 100\%$	ZERO	0.40	-0.50	0.04	0.12	
	UPSCALE	0.10	1.87	0.08	0.04	
Average Bias Response for zero Gas, $C_o = (C_{bi,zero} + C_{bf,zero})/2$		0.10	1.87	0.08	0.04	
Average Bias Response for Upscale Gas, $C_m = (C_{bi,upscale} + C_{bf,upscale})/2$		22.35	85.42	9.06	9.09	
Average Measured Concentration, Cavg		13.03	2.23	14.03	5.65	
<b>Drift Corrected Concentration, <math>C_{gas} = (C_{avg} - C_o) \times C_{ma} / (C_m - C_o)</math></b>		<b>13.74</b>	<b>0.38</b>	<b>14.08</b>	<b>5.65</b>	
<b>Drift Corrected Concentration, <math>C_{gas} = (C_{avg} - C_o) \times C_{ma} / (C_m - C_o)</math> @ 15% O2</b>		<b>11.90</b>	<b>0.33</b>	-	-	

## RM-CEMS Calibration Check

**Facility:** Santa Maria Landfill  
**Source:** Flare  
**Load:** Normal  
**Start Date:** 9/9/2010

Parameter		NOx	CO	O <sub>2</sub>	CO <sub>2</sub>
<b>A</b>	<b>Span Gas Concentration</b>				
	<b>HIGH</b>	41.60	87.40	22.21	18.35
<b>B</b>	<b>MID</b>	23.64	34.96	9.06	9.12
<b>C</b>	<b>Initial Analyzer Response</b>				
	<b>ZERO</b>	0.10	0.02	0.02	0.01
<b>D</b>	<b>HIGH</b>	41.60	87.72	22.21	18.27
<b>E</b>	<b>MID</b>	22.80	35.02	9.05	9.15
<b>F</b>	<b>Final Analyzer Response</b>				
	<b>ZERO</b>	0.00	0.02	0.06	0.03
<b>G</b>	<b>HIGH</b>	41.20	86.72	22.19	18.23
<b>H</b>	<b>MID</b>	22.60	32.92	9.07	9.14
<b>I</b>	<b>Analyzer Range</b>	50	100	25	25
<b>J</b>	<i>Linearity = <math>\{[B - ((E-C)(A/(D-C)))]/I\} \times 100</math></i>	1.8	0.1	0.1	-0.3
<b>K</b>	<i>Cal Error, Zero (%F.S.) = <math>[(F-C)/I] \times 100</math></i>	-0.2	0.0	0.2	0.1
<b>L</b>	<i>Cal Error, Mid (%F.S.) = <math>\{[(H-F)-(E-C)]/I\} \times 100</math></i>	-0.2	-2.1	-0.1	-0.1
<b>M</b>	<i>Cal Error, High (%F.S.) = <math>\{[(G-F)-(D-C)]/I\} \times 100</math></i>	-0.6	-1.0	-0.2	-0.2
<b>N</b>	<i>Average NOx Converter Test, (%) - (from stripchart)</i>	91.5			

### Calibration Error, Bias, Drift & Drift-Corrected Concentrations

Run Number: 3

CEM Operator: RPL

**Facility:** Santa Maria Landfill      **Start Time:** 15:37  
**Source:** Flare      **End Time:** 17:23  
**Load:** Normal  
**Start Date:** 9/10/2010

Species		NOx	CO	O2	CO2
Concentration Unit		%, dry	%, dry	ppmv, dry	ppmv, dry
High-Range Gas Fraction of Span		0.83	0.87	0.89	0.73
Span		50	100	25	25
Span Gas Concentration, Cma	HIGH	41.60	87.40	22.21	18.35
	MID	23.64	34.96	9.06	9.12
	ZERO	0.00	0.00	0.00	0.00
Initial Analyzer Calibration Check, Cai (Must repeat if drift from previous test >=3% Otherwise, copy calibration check from most recent cal. error determ	HIGH	41.60	87.62	22.16	18.26
	MID	23.30	33.72	9.03	9.15
	ZERO	0.00	0.02	0.01	0.00
Initial Analyzer Calibration Error, Ei Ei = ((Cma - Cai)/Span)x100%	HIGH	0.00	0.22	-0.20	-0.36
	MID	-0.68	-1.24	-0.12	0.13
	ZERO	0.00	0.02	0.04	0.00
Initial Bias Check, Cbi Upscale High (H) or Mid (M)? UPSCALE (Select Upscale Calibration Gas Closest to Stack Gas Concentration	M	M	H	M	M
	UPSCALE	22.60	86.82	8.99	9.10
	ZERO	0.00	3.12	0.03	0.02
Initial System Calibration Bias, Bi Bi = ((Cbi-Cai)/Span)x100%	UPSCALE	-1.40	-0.80	-0.16	-0.20
	ZERO	0.00	3.10	0.08	0.08
Final Bias Check, Cbf (Select Upscale Calibration Gas Closest to Stack Gas Concentration	UPSCALE	22.90	85.92	8.97	9.09
	ZERO	0.20	2.52	0.00	0.00
Final System Calibration Bias, Bf Bf = ((Cbf - Cai)/(Span))x100%	UPSCALE	-0.80	-1.70	-0.24	-0.24
	ZERO	0.40	2.50	-0.04	0.00
Drift Check, D D = ((Cbf - Cbi)/(Span))x100%	UPSCALE	0.60	-0.90	-0.08	-0.04
	ZERO	0.40	-0.60	-0.12	-0.08
Average Bias Response for zero Gas, Co=(Cbi,zero+Cbf,zero)/2		0.10	2.82	0.02	0.01
Average Bias Response for Upscale Gas, Cm=(Cbi,upscale+Cbf,upscale)/2		22.75	86.37	8.98	9.10
Average Measured Concentration, Cavg		13.53	2.77	13.98	5.60
<b>Drift Corrected Concentration, Cgas=(Cavg-Co)xCma/(Cm-Co)</b>		<b>14.01</b>	<b>-0.05</b>	<b>14.12</b>	<b>5.61</b>
<b>Drift Corrected Concentration, Cgas=(Cavg-Co)xCma/(Cm-Co) @ 15% O2</b>		<b>12.20</b>	<b>-0.04</b>	-	-



## Calibration Error, Bias, Drift & Drift-Corrected Concentrations

Run Number: 4

**Facility:** Santa Maria Landfill      Start Time: 20:10  
**Source:** Flare                              End Time: 21:30  
**Load:** Normal  
**Start Date:** 9/10/2010

Concentration Unit		NOx	CO	O2	CO2
High-Range Gas Fraction of Span		%, dry	%, dry	ppmv, dry	ppmv, dry
High-Range Gas Fraction of Span		0.83	0.87	0.89	0.73
Span		50	100	25	25
Span Gas Concentration, Cma	HIGH	41.60	87.40	22.21	18.35
	MID	23.64	34.96	9.06	9.12
	ZERO	0.00	0.00	0.00	0.00
Drift Check from Previous Run less than 3 %? Yes (Y) or No (N)	UPSCALE	Yes	Yes	Yes	Yes
	ZERO	Yes	Yes	Yes	Yes
Initial Analyzer Calibration Check, Cai (Must repeat if drift from previous test >=3% Otherwise, copy calibration check from most recent cal. error determ	HIGH	41.60	87.62	22.16	18.26
	MID	23.30	33.72	9.03	9.15
	ZERO	0.00	0.02	0.01	0.00
Initial Analyzer Calibration Error, Ei $E_i = ((C_{ma} - C_{ai})/Span) \times 100\%$	HIGH	0.00	0.22	-0.20	-0.36
	MID	-0.68	-1.24	-0.12	0.13
	ZERO	0.00	0.02	0.04	0.00
Initial Bias Check, Cbi Upscale High (H) or Mid (M)? (Select Upscale Calibration Gas Closest to Stack Gas Concentration	M	M	H	M	M
	UPSCALE	22.20	85.72	8.98	9.07
	ZERO	0.10	2.22	0.04	0.01
Initial System Calibration Bias, Bi $B_i = ((C_{bi} - C_{ai})/Span) \times 100\%$	UPSCALE	-2.20	-1.90	-0.20	-0.32
	ZERO	0.20	2.20	0.12	0.04
Final Bias Check, Cbf (Select Upscale Calibration Gas Closest to Stack Gas Concentration	UPSCALE	22.00	85.62	8.99	9.11
	ZERO	0.20	0.02	0.02	0.02
Final System Calibration Bias, Bf $B_f = ((C_{bf} - C_{ai})/(Span)) \times 100\%$	UPSCALE	-2.60	-2.00	-0.16	-0.16
	ZERO	0.40	0.00	0.04	0.08
Drift Check, D $D = ((C_{bf} - C_{bi})/(Span)) \times 100\%$	UPSCALE	-0.40	-0.10	0.04	0.16
	ZERO	0.20	-2.20	-0.08	0.04
Average Bias Response for zero Gas, $C_o = (C_{bi,zero} + C_{bf,zero})/2$		0.15	1.12	0.03	0.02
Average Bias Response for Upscale Gas, $C_m = (C_{bi,upscale} + C_{bf,upscale})/2$		22.10	85.67	8.99	9.09
Average Measured Concentration, Cavg	*	13.20	2.20	13.71	5.70
<b>Drift Corrected Concentration, <math>C_{gas} = (C_{avg} - C_o) \times C_{ma} / (C_m - C_o)</math></b>		<b>14.05</b>	<b>1.12</b>	<b>13.84</b>	<b>5.71</b>
<b>Drift Corrected Concentration, <math>C_{gas} = (C_{avg} - C_o) \times C_{ma} / (C_m - C_o)</math> @ 15% O2</b>		<b>12.24</b>	<b>0.97</b>	-	-

\* Note: Das data lost, Values are average from strip chart.

## RM-CEMS Calibration Check

**Facility:** Santa Maria Landfill  
**Source:** Flare  
**Load:** Normal  
**Start Date:** 9/10/2010

Parameter		NO <sub>x</sub>	CO	O <sub>2</sub>	CO <sub>2</sub>
<b>A</b>	<b>Span Gas Concentration</b>				
	<b>HIGH</b>	41.60	87.40	22.21	18.35
<b>B</b>	<b>MID</b>	23.64	34.96	9.06	9.12
<b>C</b>	<b>Initial Analyzer Response</b>				
	<b>ZERO</b>	0.00	0.02	0.01	0.00
<b>D</b>	<b>HIGH</b>	41.60	87.62	22.16	18.27
<b>E</b>	<b>MID</b>	23.30	33.72	9.03	9.15
<b>F</b>	<b>Final Analyzer Response</b>				
	<b>ZERO</b>	0.01	0.02	-0.01	0.01
<b>G</b>	<b>HIGH</b>	40.80	87.02	22.14	18.30
<b>H</b>	<b>MID</b>	22.20	34.62	9.01	9.16
<b>I</b>	<b>Analyzer Range</b>	50	100	25	25
<b>J</b>	<i>Linearity = <math>\{[B - ((E-C)(A/(D-C)))]/I\} \times 100</math></i>	0.7	1.3	0.1	-0.3
<b>K</b>	<i>Cal Error, Zero (%F.S.) = <math>[(F-C)/I] \times 100</math></i>	0.0	0.0	-0.1	0.0
<b>L</b>	<i>Cal Error, Mid (%F.S.) = <math>[\{(H-F)-(E-C)\}/I] \times 100</math></i>	-2.2	0.9	0.0	0.0
<b>M</b>	<i>Cal Error, High (%F.S.) = <math>[\{(G-F)-(D-C)\}/I] \times 100</math></i>	-1.6	-0.6	0.0	0.1
<b>N</b>	<i>Average NO<sub>x</sub> Converter Test, (%) - (from stripchart)</i>	91.5			

## Calibration Error, Bias, Drift & Drift-Corrected Concentrations

Run Number: 5

**Facility:** Santa Maria Landfill      Start Time: 11:17  
**Source:** Flare                              End Time: 12:29  
**Load:** Normal  
**Start Date:** 9/11/2010

High-Range Gas Fraction of Span		NOx	CO	O2	CO2
High-Range Gas Fraction of Span		%, dry	%, dry	ppmv, dry	ppmv, dry
High-Range Gas Fraction of Span		0.83	0.87	0.89	0.73
Span		50	100	25	25
Span Gas Concentration, Cma	HIGH	41.60	87.40	22.21	18.35
	MID	23.64	34.96	9.06	9.12
	ZERO	0.00	0.00	0.00	0.00
Initial Analyzer Calibration Check, Cai (Must repeat if drift from previous test >=3% Otherwise, copy calibration check from most recent cal. error detern	HIGH	40.80	87.42	22.22	18.30
	MID	22.90	34.72	9.06	9.16
	ZERO	0.00	0.02	0.02	0.00
Initial Analyzer Calibration Error, Ei Ei = ((Cma - Cai)/Span)x100%	HIGH	-1.60	0.02	0.04	-0.20
	MID	-1.48	-0.24	0.00	0.17
	ZERO	0.00	0.02	0.08	0.00
Initial Bias Check, Cbi Upscale High (H) or Mid (M)? UPSCALE	M		H	M	M
	UPSCALE	22.50	85.72	9.03	9.10
	ZERO	0.00	2.32	0.05	0.00
(Select Upscale Calibration Gas Closest to Stack Gas Concentration					
Initial System Calibration Bias, Bi Bi = ((Cbi - Cai)/Span)x100%	UPSCALE	-0.80	-1.70	-0.12	-0.24
	ZERO	0.00	2.30	0.12	0.00
Final Bias Check, Cbf (Select Upscale Calibration Gas Closest to Stack Gas Concentration	UPSCALE	23.20	86.02	9.02	9.09
	ZERO	0.30	2.82	0.06	0.01
Final System Calibration Bias, Bf Bf = ((Cbf - Cai)/(Span))x100%	UPSCALE	0.60	-1.40	-0.16	-0.28
	ZERO	0.60	2.80	0.16	0.04
Drift Check, D D = ((Cbf - Cbi)/(Span))x100%	UPSCALE	1.40	0.30	-0.04	-0.04
	ZERO	0.60	0.50	0.04	0.04
Average Bias Response for zero Gas, Co=(Cbi,zero+Cbf,zero)/2		0.15	2.57	0.06	0.01
Average Bias Response for Upscale Gas, Cm=(Cbi,upscale+Cbf,upscale)/2		22.85	85.87	9.03	9.10
Average Measured Concentration, Cavg		13.57	2.54	13.79	5.56
<b>Drift Corrected Concentration, Cgas=(Cavg-Co)xCma/(Cm-Co)</b>		<b>13.98</b>	<b>-0.03</b>	<b>13.88</b>	<b>5.57</b>
<b>Drift Corrected Concentration, Cgas=(Cavg-Co)xCma/(Cm-Co) @ 15% O2</b>		<b>12.17</b>	<b>-0.03</b>	-	-

## Calibration Error, Bias, Drift & Drift-Corrected Concentrations

Run Number: 6

**Facility:** Santa Maria Landfill      Start Time: 14:44  
**Source:** Flare                              End Time: 15:45  
**Load:** Normal  
**Start Date:** 9/11/2010

High-Range Gas Fraction of Span		NOx	CO	O2	CO2
High-Range Gas Fraction of Span		%, dry	%, dry	ppmv, dry	ppmv, dry
High-Range Gas Fraction of Span		0.83	0.87	0.89	0.73
Span		50	100	25	25
Span Gas Concentration, Cma	HIGH	41.60	87.40	22.21	18.35
	MID	23.64	34.96	9.06	9.12
	ZERO	0.00	0.00	0.00	0.00
Drift Check from Previous Run less than 3 %? Yes (Y) or No (N)	UPSCALE	Yes	Yes	Yes	Yes
	ZERO	Yes	Yes	Yes	Yes
Initial Analyzer Calibration Check, Cai (Must repeat if drift from previous test >=3% Otherwise, copy calibration check from most recent cal. error determ	HIGH	40.80	87.42	22.22	18.30
	MID	22.90	34.72	9.06	9.16
	ZERO	0.00	0.02	0.02	0.00
Initial Analyzer Calibration Error, Ei Ei = ((Cma - Cai)/Span)x100%	HIGH	-1.60	0.02	0.04	-0.20
	MID	-1.48	-0.24	0.00	0.17
	ZERO	0.00	0.02	0.08	0.00
Initial Bias Check, Cbi Upscale High (H) or Mid (M)? (Select Upscale Calibration Gas Closest to Stack Gas Concentration	UPSCALE	M	H	M	M
	UPSCALE	23.00	86.62	9.10	9.08
	ZERO	0.10	2.32	0.12	-0.01
Initial System Calibration Bias, Bi Bi = ((Cbi-Cai)/Span)x100%	UPSCALE	0.20	-0.80	0.16	-0.32
	ZERO	0.20	2.30	0.40	-0.04
Final Bias Check, Cbf (Select Upscale Calibration Gas Closest to Stack Gas Concentration	UPSCALE	23.30	86.02	9.02	9.04
	ZERO	0.30	2.62	0.07	0.00
Final System Calibration Bias, Bf Bf = ((Cbf - Cai)/(Span))x100%	UPSCALE	0.80	-1.40	-0.16	-0.48
	ZERO	0.60	2.60	0.20	0.00
Drift Check, D D = ((Cbf - Cbi)/(Span))x100%	UPSCALE	0.60	-0.60	-0.32	-0.16
	ZERO	0.40	0.30	-0.20	0.04
Average Bias Response for zero Gas, Co=(Cbi,zero+Cbf,zero)/2		0.20	2.47	0.10	-0.01
Average Bias Response for Upscale Gas, Cm=(Cbi,upscale+Cbf,upscale)/2		23.15	86.32	9.06	9.06
Average Measured Concentration, Cavg		13.64	2.59	13.84	5.48
<b>Drift Corrected Concentration, Cgas=(Cavg-Co)xCma/(Cm-Co)</b>		<b>13.85</b>	<b>0.13</b>	<b>13.89</b>	<b>5.52</b>
<b>Drift Corrected Concentration, Cgas=(Cavg-Co)xCma/(Cm-Co) @ 15% O2</b>		<b>12.06</b>	<b>0.11</b>	<b>-</b>	<b>-</b>

## RM-CEMS Calibration Check

**Facility:** Santa Maria Landfill  
**Source:** Flare  
**Load:** Normal  
**Start Date:** 9/11/2010

Parameter		NO <sub>x</sub>	CO	O <sub>2</sub>	CO <sub>2</sub>
<b>A</b>	Span Gas Concentration <b>HIGH</b>	41.60	87.40	22.21	18.35
<b>B</b>	<b>MID</b>	23.64	34.96	9.06	9.12
<b>C</b>	Initial Analyzer Response <b>ZERO</b>	0.00	0.02	0.02	0.00
<b>D</b>	<b>HIGH</b>	40.80	87.42	22.22	18.30
<b>E</b>	<b>MID</b>	22.90	34.72	9.06	9.16
<b>F</b>	Final Analyzer Response <b>ZERO</b>	0.00	0.62	0.04	0.00
<b>G</b>	<b>HIGH</b>	42.20	87.32	22.17	18.23
<b>H</b>	<b>MID</b>	23.10	34.72	9.05	9.12
<b>I</b>	Analyzer Range	50	100	25	25
<b>J</b>	<i>Linearity = <math>\{[B - ((E-C)(A/(D-C)))]/I\} \times 100</math></i>	0.6	0.3	0.1	-0.3
<b>K</b>	<i>Cal Error, Zero (%F.S.) = <math>[(F-C)/I] \times 100</math></i>	0.0	0.6	0.1	0.0
<b>L</b>	<i>Cal Error, Mid (%F.S.) = <math>\{[(H-F)-(E-C)]/I\} \times 100</math></i>	0.4	-0.6	-0.1	-0.2
<b>M</b>	<i>Cal Error, High (%F.S.) = <math>\{[(G-F)-(D-C)]/I\} \times 100</math></i>	2.8	-0.7	-0.3	-0.3
<b>N</b>	<i>Average NO<sub>x</sub> Converter Test, (%) - (from stripchart)</i>	91.5			

## MASS FLOW DILUTER CHECK

**Facility:** Santa Maria Landfill      **Analyt:** NOx  
**Source:** Flare      **Range:** 50  
**Test Date:** 9/9/2010 - 9/11/2010      **Dilution Gas Conc.:** 41.6

Dilution (%)	100	60	40	Challenge Gas
Expected Value	41.60	24.96	16.64	23.64
Run 1 Actual Value	41.80	25.10	16.50	23.00
Run 1 % Error	0.48	0.56	0.84	2.71

PASS

# Total Air Analysis Data Acquisition

Santa Maria Flare Run #6

Date	Time	RM O <sub>2</sub> (%)	RM CO <sub>2</sub> (%) CO <sub>2</sub> %	RM NO <sub>x</sub> (ppm) NO <sub>x</sub>	RM CO (ppm) CO #2
09/11/10	14:44:25	14.03	5.35	13.1	2.6
09/11/10	14:45:25	13.81	5.52	13.6	2.5
09/11/10	14:46:25	13.76	5.56	13.8	2.7
09/11/10	14:47:25	13.77	5.56	13.8	2.5
09/11/10	14:48:25	13.89	5.46	13.6	2.7
09/11/10	14:49:25	13.85	5.49	13.6	2.7
09/11/10	14:50:25	13.9	5.44	13.4	2.6
09/11/10	14:51:25	13.88	5.48	13.6	2.6
09/11/10	14:52:25	13.78	5.54	13.7	2.6
09/11/10	14:53:25	13.87	5.46	13.4	2.5
09/11/10	14:54:25	14.09	5.29	12.9	2.6
09/11/10	14:55:25	13.98	5.39	13.4	2.7
09/11/10	14:56:25	14.02	5.35	13.2	2.6
09/11/10	14:57:25	13.9	5.45	13.5	2.6
09/11/10	14:58:25	13.88	5.45	13.5	2.7
09/11/10	14:59:25	13.87	5.47	13.6	2.6
09/11/10	15:00:25	13.9	5.45	13.6	2.6
09/11/10	15:01:25	13.66	5.63	14	2.6
09/11/10	15:02:25	13.99	5.38	13.4	2.6
09/11/10	15:03:25	13.89	5.43	13.5	2.6
09/11/10	15:04:25	13.97	5.38	13.3	2.5
09/11/10	15:05:25	13.93	5.42	13.5	2.6
09/11/10	15:06:25	13.95	5.38	13.4	2.7
09/11/10	15:07:25	13.89	5.44	13.6	2.7
09/11/10	15:08:25	13.61	5.68	14.2	2.6
09/11/10	15:09:25	13.98	5.37	13.3	2.6

09/11/10	15:10:25	13.64	5.65	14.2	2.6
09/11/10	15:11:25	13.81	5.51	13.7	2.6
09/11/10	15:12:25	13.83	5.5	13.8	2.7
09/11/10	15:13:25	14.1	5.28	13.1	2.6
09/11/10	15:14:25	13.89	5.45	13.6	2.7
09/11/10	15:15:25	14.02	5.33	13.3	2.5
09/11/10	15:16:25	13.69	5.62	14.2	2.5
09/11/10	15:17:25	13.71	5.6	14	2.8
09/11/10	15:18:25	13.82	5.5	13.8	2.5
09/11/10	15:19:25	13.72	5.56	13.9	2.6
09/11/10	15:20:25	13.78	5.53	13.8	2.6
09/11/10	15:21:25	13.68	5.61	14.1	2.6
09/11/10	15:22:25	13.82	5.5	13.7	2.7
09/11/10	15:23:25	13.72	5.59	14	2.5
09/11/10	15:24:25	13.81	5.5	13.7	2.5
09/11/10	15:25:25	13.94	5.4	13.4	2.6
09/11/10	15:26:25	13.85	5.47	13.6	2.5
09/11/10	15:27:25	13.78	5.54	13.9	2.6
09/11/10	15:28:25	13.79	5.54	13.8	2.6
09/11/10	15:29:25	13.84	5.48	13.6	2.6
09/11/10	15:30:25	13.92	5.41	13.4	2.7
09/11/10	15:31:25	13.72	5.57	13.9	2.6
09/11/10	15:32:25	13.88	5.43	13.5	2.6
09/11/10	15:33:25	13.91	5.42	13.5	2.6
09/11/10	15:34:25	13.9	5.43	13.5	2.6
09/11/10	15:35:25	13.66	5.62	14	2.5
09/11/10	15:36:25	13.96	5.38	13.3	2.5
09/11/10	15:37:25	13.67	5.61	13.9	2.5
09/11/10	15:38:25	13.88	5.45	13.6	2.5
09/11/10	15:39:25	14.03	5.32	13.1	2.6
09/11/10	15:40:25	13.87	5.45	13.6	2.5
09/11/10	15:41:25	13.7	5.6	14.1	2.6
09/11/10	15:42:25	13.69	5.6	14	2.6
09/11/10	15:43:25	13.67	5.63	14.1	2.6
09/11/10	15:44:25	13.7	5.59	13.9	2.6
09/11/10	15:45:25	13.74	5.55	13.8	2.4
	<b>Average</b>	<b>13.84</b>	<b>5.48</b>	<b>13.64</b>	<b>2.59</b>



09/11/10	15:47:25	0.33	0.06	23	2.6	Cals.
09/11/10	15:48:25	0.09	0.01	23.3	2.6	
09/11/10	15:49:25	4.67	3.61	14.9	2.5	
09/11/10	15:50:25	9	9	0.6	2.4	
09/11/10	15:51:25	8.98	8.95	0.8	2.4	
09/11/10	15:52:25	9.44	8.17	1.4	3.7	
09/11/10	15:53:25	8.14	8.53	0.7	2.7	
09/11/10	15:54:25	0.1	0.07	0.3	83.9	
09/11/10	15:55:25	0.07	0.01	0.3	85.7	
09/11/10	15:56:25	0.06	0	0.3	85.7	
09/11/10	15:57:25	0.09	0	0.3	47.6	
09/11/10	15:58:25	0	0	0	0.3	
09/11/10	15:59:25	8.98	8.98	5.8	86.8	

**Total Air Analysis Data Acquisition**  
**Santa Maria Flare Run #5**

Date	Time	RM O <sub>2</sub>	RM CO <sub>2</sub>	RM NO <sub>x</sub>	RM CO
		(%) 0.02	(%) CO2 %	(ppm) NO <sub>x</sub>	(ppm) C0 #2
09/11/10	11:17:02	13.66	5.69	13.8	2.4
09/11/10	11:18:02	13.84	5.53	13.3	2.3
09/11/10	11:19:02	13.75	5.61	13.6	2.3
09/11/10	11:20:02	13.8	5.56	13.5	2.4
09/11/10	11:21:02	13.68	5.66	13.8	2.4
09/11/10	11:22:02	13.76	5.59	13.5	2.4
09/11/10	11:23:02	13.74	5.64	13.8	2.4
09/11/10	11:24:02	13.72	5.62	13.6	2.4
09/11/10	11:25:02	13.8	5.57	13.5	2.4
09/11/10	11:26:02	13.72	5.62	13.6	2.4
09/11/10	11:27:02	13.99	5.39	12.8	2.5
09/11/10	11:28:02	13.85	5.53	13.5	2.4
09/11/10	11:29:02	14.08	5.33	12.7	2.8
09/11/10	11:30:02	13.86	5.51	13.4	2.4
09/11/10	11:31:02	14.05	5.36	12.9	2.4
09/11/10	11:32:02	14.07	5.37	13.1	2.4
09/11/10	11:33:02	13.82	5.54	13.5	2.5
09/11/10	11:34:02	13.73	5.62	13.7	2.4
09/11/10	11:35:02	13.7	5.64	13.8	2.4
09/11/10	11:36:02	13.82	5.54	13.4	2.5
09/11/10	11:37:02	13.94	5.45	13.3	2.4
09/11/10	11:38:02	13.81	5.54	13.4	2.4
09/11/10	11:39:02	13.8	5.57	13.6	2.5
09/11/10	11:40:02	13.62	5.71	13.9	2.5
09/11/10	11:41:02	13.72	5.64	13.8	2.5
09/11/10	11:42:02	13.83	5.55	13.5	2.5
09/11/10	11:43:02	13.74	5.62	13.7	2.5
09/11/10	11:44:02	13.74	5.6	13.6	2.5
09/11/10	11:45:02	13.81	5.56	13.6	2.4

09/11/10	11:46:02	13.8	5.56	13.5	2.5
09/11/10	11:47:02	13.61	5.7	14	2.5
09/11/10	11:48:02	13.71	5.63	13.8	2.5
09/11/10	11:49:02	13.87	5.51	13.4	2.5
09/11/10	11:50:02	13.76	5.58	13.6	2.5
09/11/10	11:51:02	13.74	5.63	13.8	2.5
09/11/10	11:52:02	13.77	5.58	13.5	2.5
09/11/10	11:53:02	13.73	5.62	13.8	2.6
09/11/10	11:54:02	13.96	5.44	13.3	2.5
09/11/10	11:55:02	13.87	5.47	13.4	2.5
09/11/10	11:56:02	13.76	5.57	13.6	2.5
09/11/10	11:57:02	13.8	5.56	13.6	2.5
09/11/10	11:58:02	13.73	5.6	13.8	2.5
09/11/10	11:59:02	13.87	5.49	13.5	2.5
09/11/10	12:00:02	13.87	5.48	13.3	2.6
09/11/10	12:01:02	13.67	5.67	14	2.5
09/11/10	12:02:02	13.75	5.6	13.7	2.6
09/11/10	12:03:02	13.77	5.58	13.7	2.6
09/11/10	12:04:02	14.19	5.23	12.5	3.3
09/11/10	12:05:02	13.63	5.7	14.1	2.5
09/11/10	12:06:02	13.71	5.64	13.9	2.6
09/11/10	12:07:02	13.86	5.51	13.5	2.6
09/11/10	12:08:02	13.7	5.64	13.9	2.6
09/11/10	12:09:02	13.71	5.63	13.8	2.6
09/11/10	12:10:02	13.71	5.62	13.9	2.6
09/11/10	12:11:02	13.81	5.56	13.7	2.6
09/11/10	12:12:02	13.89	5.46	13.4	2.6
09/11/10	12:13:02	13.64	5.68	13.9	2.6
09/11/10	12:14:02	13.78	5.56	13.7	2.6
09/11/10	12:15:02	13.75	5.61	13.9	2.6
09/11/10	12:16:02	13.79	5.57	13.6	2.5
09/11/10	12:17:02	14.03	5.36	13	2.6
09/11/10	12:18:02	13.82	5.53	13.6	2.7
09/11/10	12:19:02	13.77	5.6	13.8	2.6
09/11/10	12:20:02	13.76	5.59	13.8	2.7

09/11/10	12:21:02	14.01	5.38	13.1	2.7
09/11/10	12:22:02	13.76	5.58	13.8	2.7
09/11/10	12:23:02	13.86	5.52	13.7	2.6
09/11/10	12:24:02	13.66	5.67	14.1	2.8
09/11/10	12:25:02	13.73	5.61	13.8	2.7
09/11/10	12:26:02	13.85	5.5	13.6	2.8
09/11/10	12:27:02	13.68	5.56	13.8	2.7
09/11/10	12:28:02	13.68	5.55	13.3	2.6
09/11/10	12:29:02	13.71	5.53	13.1	2.7

**Average      13.79      5.56      13.57      2.54**

09/11/10	12:30:02	13.73	5.58	12.7	3.1	Cals.
09/11/10	12:31:02	1.92	0.49	20.6	2.8	
09/11/10	12:32:02	0.07	0.01	23.2	2.8	
09/11/10	12:33:02	0.07	0.01	23.2	2.9	
09/11/10	12:34:02	8.7	8.63	1.7	3	
09/11/10	12:35:02	9.01	9.06	0.5	2.9	
09/11/10	12:36:02	9.02	9.08	0.5	3	
09/11/10	12:37:02	9.02	9.09	0.5	2.9	
09/11/10	12:38:02	9.02	9.09	0.4	2.9	
09/11/10	12:39:02	5.98	6.34	0.4	2.8	
09/11/10	12:40:02	0.09	0.07	0.3	84.4	
09/11/10	12:41:02	0.05	0.01	0.3	85.9	
09/11/10	12:42:02	19.21	0.03	0.2	3.1	
09/11/10	12:43:02	20.67	0.04	0.2	4	
09/11/10	12:44:02	20.67	0.04	0.2	4.4	
09/11/10	12:45:02	20.66	0.03	0.2	4.5	
09/11/10	12:46:02	20.67	0.04	0.1	1.4	

# Total Air Analysis Data Acquisition

## Santa Maria Flare Run #3

<b>Date</b>	<b>Time</b>	<b>RM O2</b> (%) 0.02	<b>RM CO2</b> (%) CO2 %	<b>RM NOx</b> (ppm) NOx	<b>RM CO</b> (ppm) CO #2
09/10/10	15:37:55	13.88	5.69	13.5	2.8
09/10/10	15:38:55	14.29	5.34	12.7	4.4
09/10/10	15:39:55	14.05	5.54	13.2	2.7
09/10/10	15:40:55	14.10	5.52	13.2	2.8
09/10/10	15:41:55	13.87	5.73	13.8	2.7
09/10/10	15:42:55	14.02	5.56	13.3	2.7
09/10/10	15:43:55	13.88	5.73	13.7	2.8
09/10/10	15:44:55	14.04	5.56	13.3	2.7
09/10/10	15:45:55	13.84	5.72	13.6	2.7
09/10/10	15:46:55	14.15	5.46	12.9	2.7
09/10/10	15:47:55	14.15	5.45	12.8	2.8
09/10/10	15:48:55	13.81	5.76	13.8	2.7
09/10/10	15:49:55	14.05	5.57	13.2	2.7
09/10/10	15:50:55	14.09	5.52	13	2.7
09/10/10	15:51:55	14.08	5.53	13.1	2.6
09/10/10	15:52:55	14.03	5.57	13.1	2.7
09/10/10	15:53:55	14.04	5.54	13.1	4.4
09/10/10	15:54:55	14.07	5.54	13.2	2.7
09/10/10	15:55:55	14.10	5.49	13.1	2.7
09/10/10	15:56:55	13.81	5.75	13.8	2.8
09/10/10	15:57:55	13.96	5.61	13.5	2.6
09/10/10	15:58:55	13.93	5.66	13.6	2.7
09/10/10	15:59:55	14.18	5.45	13.1	2.6
09/10/10	16:00:55	14.00	5.60	13.3	2.6
09/10/10	16:01:55	14.15	5.52	13.3	2.6
09/10/10	16:02:55	13.81	5.74	13.8	2.6
09/10/10	16:03:55	13.83	5.73	13.8	2.6

09/10/10	16:04:55	13.99	5.60	13.5	2.6
09/10/10	16:05:55	13.86	5.72	13.7	2.7
09/10/10	16:06:55	13.87	5.70	13.8	2.7
09/10/10	16:07:55	13.80	5.80	14.1	2.8
09/10/10	16:08:55	14.00	5.60	13.5	2.7
09/10/10	16:09:55	14.03	5.58	13.5	2.7
09/10/10	16:10:55	14.15	5.47	13.1	2.6
09/10/10	16:11:55	14.01	5.57	13.5	2.8
09/10/10	16:12:55	13.78	5.78	14	2.7
09/10/10	16:13:55	14.12	5.49	13.1	3.2
09/10/10	16:14:55	14.04	5.56	13.4	2.6
09/10/10	16:15:55	13.90	5.68	13.7	2.6
09/10/10	16:16:55	14.02	5.55	13.3	2.7
09/10/10	16:17:55	13.94	5.61	13.6	2.7
09/10/10	16:18:55	14.07	5.53	13.3	2.7
09/10/10	16:19:55	13.82	5.76	14	2.8
09/10/10	16:20:55	13.98	5.60	13.5	2.7
09/10/10	16:21:55	14.01	5.55	13.4	2.7
09/10/10	16:22:55	13.79	5.75	14	2.9
09/10/10	16:23:55	14.05	5.53	13.3	3.0
09/10/10	16:24:55	13.91	5.68	13.8	2.6
09/10/10	16:25:55	13.91	5.65	13.7	2.7
09/10/10	16:26:55	13.90	5.69	13.9	2.6
09/10/10	16:27:55	13.90	5.68	13.8	2.7
09/10/10	16:28:55	14.00	5.57	13.6	2.7
09/10/10	16:29:55	13.96	5.62	13.8	2.6
09/10/10	16:30:55	13.96	5.62	13.7	2.7
09/10/10	16:31:55	13.82	5.74	14.2	2.6
09/10/10	16:32:55	14.05	5.56	13.5	2.7
09/10/10	16:33:55	13.99	5.62	13.7	2.7
09/10/10	16:34:55	14.10	5.43	13.1	2.6
09/10/10	16:35:55	14.21	5.40	12.9	4.6
09/10/10	16:36:55	13.82	5.74	13.8	2.7

09/10/10	16:37:55	13.89	5.70	13.8	2.7
09/10/10	16:38:55	13.92	5.67	13.8	2.7
09/10/10	16:39:55	14.03	5.56	13.3	2.7
09/10/10	16:40:55	14.05	5.56	13.5	2.7
09/10/10	16:41:55	14.07	5.53	13.4	2.6
09/10/10	16:42:55	13.92	5.68	13.8	2.6
09/10/10	16:43:55	13.95	5.64	13.7	2.7
09/10/10	16:44:55	13.78	5.81	14.2	2.7
09/10/10	16:45:55	14.17	5.46	13.2	2.8
09/10/10	16:46:55	14.13	5.49	13.3	2.6
09/10/10	16:47:55	14.06	5.53	13.3	2.7
09/10/10	16:48:55	13.82	5.74	14	2.8
09/10/10	16:49:55	14.05	5.52	13.3	2.8
09/10/10	16:50:55	14.00	5.59	13.4	2.7
09/10/10	16:51:55	13.90	5.66	13.6	2.6
09/10/10	16:52:55	14.00	5.58	13.5	2.7
09/10/10	16:53:55	14.17	5.42	12.9	3.8
09/10/10	16:54:55	14.00	5.57	13.5	2.6
09/10/10	16:55:55	13.72	5.81	14.1	2.7
09/10/10	16:56:55	13.78	5.77	14.1	2.8
09/10/10	16:57:55	14.09	5.51	13.2	2.8
09/10/10	16:58:55	13.88	5.68	13.7	2.7
09/10/10	16:59:55	14.17	5.42	13.1	3.5
09/10/10	17:00:55	14.11	5.48	13.3	2.8
09/10/10	17:01:55	14.06	5.52	13.5	2.7
09/10/10	17:02:55	13.94	5.63	13.8	2.6
09/10/10	17:03:55	13.83	5.71	13.9	2.7
09/10/10	17:04:55	13.97	5.62	13.8	2.7
09/10/10	17:05:55	13.87	5.72	13.9	2.7
09/10/10	17:06:55	14.03	5.55	13.4	2.8
09/10/10	17:07:55	13.95	5.64	13.8	2.7
09/10/10	17:08:55	14.00	5.59	13.6	2.8
09/10/10	17:09:55	14.03	5.55	13.5	2.7

09/10/10	17:10:55	13.94	5.64	13.8	2.7
09/10/10	17:11:55	13.86	5.68	13.9	2.7
09/10/10	17:12:55	13.91	5.64	13.7	2.7
09/10/10	17:13:55	14.14	5.45	13.2	3.0
09/10/10	17:14:55	14.01	5.59	13.7	2.6
09/10/10	17:15:55	13.85	5.71	13.8	2.7
09/10/10	17:16:55	13.99	5.58	13.5	2.7
09/10/10	17:17:55	14.14	5.47	13.3	2.7
09/10/10	17:18:55	14.02	5.56	13.5	2.8
09/10/10	17:20:04	14.01	5.52	13.4	2.6
09/10/10	17:20:55	13.75	5.79	14.3	2.7
09/10/10	17:21:55	13.97	5.62	13.7	2.8
09/10/10	17:22:55	13.90	5.67	13.7	2.6
09/10/10	17:23:55	14.33	5.44	13.2	2.8
	<b>Average</b>	<b>13.98</b>	<b>5.60</b>	<b>13.5</b>	<b>2.77</b>



# Total Air Analysis Data Acquisition

Santa Maria Flare Run #2

Date	Time	RM O2 (%) O2 %	RM CO2 (%) CO2 %	RM NOx (ppm) NOX	RM CO (ppm) CO #2
09/09/10	18:54:09	13.97	5.67	13.40	2.2
09/09/10	18:55:09	13.94	5.67	13.30	2.2
09/09/10	18:56:17	13.94	5.67	13.40	2.2
09/09/10	18:57:09	13.91	5.72	13.60	2.2
09/09/10	18:58:17	14.10	5.55	13.10	2.2
09/09/10	18:59:09	13.86	5.76	13.60	2.2
09/09/10	19:00:17	13.64	5.94	14.30	2.2
09/09/10	19:01:09	13.85	5.78	13.70	2.2
09/09/10	19:02:17	14.79	5.03	11.70	2.1
09/09/10	19:03:09	14.42	5.28	12.10	4.7
09/09/10	19:04:17	13.63	5.94	14.10	2.3
09/09/10	19:05:09	12.82	6.61	16.20	2.2
09/09/10	19:06:17	13.36	6.22	12.20	2.5
09/09/10	19:07:09	15.36	4.62	10.60	3.3
09/09/10	19:08:17	14.51	5.17	11.60	3.2
09/09/10	19:09:09	13.58	5.99	14.30	2.2
09/09/10	19:10:17	13.58	6.03	13.70	2.7
09/09/10	19:11:09	13.83	5.78	13.60	2.2
09/09/10	19:12:17	13.82	5.65	13.20	2.3
09/09/10	19:13:09	13.85	5.77	13.50	2.2
09/09/10	19:14:17	13.88	5.67	13.20	2.1
09/09/10	19:15:09	13.92	5.71	13.40	2.2
09/09/10	19:16:09	13.91	5.71	13.40	2.2
09/09/10	19:17:09	14.04	5.63	13.10	2.2
09/09/10	19:18:09	13.97	5.67	13.30	2.2
09/09/10	19:19:09	14.12	5.56	12.90	2.2

09/09/10	19:20:17	14.25	5.62	12.80	2.1
09/09/10	19:21:09	13.85	5.78	13.50	2.1
09/09/10	19:22:17	13.88	5.74	13.50	2.2
09/09/10	19:23:09	13.89	5.75	13.50	2.2
09/09/10	19:24:17	13.64	5.74	13.50	2.1
09/09/10	19:25:09	13.87	5.76	13.50	2.1
09/09/10	19:26:17	13.87	5.77	13.50	2.2
09/09/10	19:27:09	14.02	5.63	13.10	2.2
09/09/10	19:28:17	13.90	5.72	13.30	2.2
09/09/10	19:29:09	13.98	5.67	13.20	2.1
09/09/10	19:30:09	13.93	5.72	13.40	2.1
09/09/10	19:31:09	14.01	5.64	13.10	2.0
09/09/10	19:32:09	14.01	5.65	13.20	2.1
09/09/10	19:33:09	14.12	5.54	12.90	2.1
09/09/10	19:34:09	14.07	5.59	12.90	2.1
09/09/10	19:35:09	14.02	5.64	13.20	2.1
09/09/10	19:36:09	13.97	5.69	13.30	2.1
09/09/10	19:37:09	14.02	5.65	13.20	2.1
09/09/10	19:38:09	13.96	5.69	13.20	2.1
09/09/10	19:39:09	14.04	5.62	13.00	2.1
09/09/10	19:40:09	13.96	5.65	13.10	2.1
09/09/10	19:41:09	13.97	5.67	13.10	2.2
09/09/10	19:42:16	13.95	5.55	13.12	2.1
09/09/10	19:43:09	13.94	5.71	13.30	2.1
09/09/10	19:44:09	14.15	5.54	12.80	2.1
09/09/10	19:45:09	14.04	5.63	13.10	2.1
09/09/10	19:46:16	14.08	5.73	13.00	2.1
09/09/10	19:47:09	14.09	5.57	12.90	2.1
09/09/10	19:48:16	14.05	5.55	13.02	2.2
09/09/10	19:49:09	13.92	5.74	13.30	2.1
09/09/10	19:50:16	13.85	7.70	12.40	2.3
09/09/10	19:51:09	14.09	5.59	12.90	2.1

09/09/10	19:52:16	14.04	5.35	12.99	2.2
09/09/10	19:53:09	14.14	5.52	12.80	2.1
09/09/10	19:54:16	14.25	5.35	12.78	2.2
09/09/10	19:55:09	14.18	5.51	12.80	2.1
09/09/10	19:56:09	14.03	5.64	13.10	2.1
09/09/10	19:57:09	14.10	5.59	13.00	2.1
09/09/10	19:58:09	14.06	5.62	13.00	2.2
09/09/10	19:59:09	14.09	5.59	12.80	1.9
09/09/10	20:00:09	14.10	5.57	12.80	1.9
09/09/10	20:01:09	14.04	5.63	13.10	1.9
09/09/10	20:02:09	14.09	5.57	12.80	2.0
09/09/10	20:03:09	14.03	5.65	13.10	2.0
09/09/10	20:04:09	14.00	5.67	13.10	1.9
09/09/10	20:05:09	14.13	5.55	12.80	1.9
09/09/10	20:06:09	14.02	5.65	13.10	2.0
09/09/10	20:07:09	14.04	5.64	13.10	2.0
09/09/10	20:08:09	14.06	5.63	13.00	1.9
09/09/10	20:09:09	14.08	5.60	12.90	1.8
09/09/10	20:10:16	13.98	5.70	13.20	1.7
09/09/10	20:11:09	14.01	5.67	13.10	1.8
09/09/10	20:12:16	14.19	5.53	12.70	1.8
09/09/10	20:13:09	14.00	5.67	13.10	1.9
09/09/10	20:14:09	13.99	5.67	13.10	1.7
09/09/10	20:15:09	14.15	5.54	12.60	2.3
09/09/10	20:16:16	13.97	5.70	13.20	1.8
09/09/10	20:17:09	13.98	5.69	13.10	1.8
09/09/10	20:18:16	14.05	5.63	12.90	1.8
09/09/10	20:19:09	14.05	5.63	12.90	1.8
09/09/10	20:20:16	13.75	5.91	13.90	0.6
09/09/10	20:21:09	13.89	5.78	13.40	1.7
09/09/10	20:22:09	14.36	5.41	12.60	1.7
09/09/10	20:23:09	14.61	5.19	11.60	7.0

09/09/10	20:24:16	14.31	5.40	12.20	4.3
09/09/10	20:25:09	14.12	5.57	12.80	1.8
09/09/10	20:26:16	14.03	5.65	12.90	1.7
09/09/10	20:27:09	13.09	6.46	15.60	1.6
09/09/10	20:28:16	14.22	5.55	13.10	1.7
09/09/10	20:29:09	14.45	5.30	12.00	4.4
09/09/10	20:30:16	14.30	5.43	12.40	2.5
09/09/10	20:31:09	14.22	5.48	12.40	3.5
09/09/10	20:32:16	14.20	5.50	12.60	2.0
09/09/10	20:33:09	14.07	5.62	12.80	1.8
09/09/10	20:34:16	14.00	5.68	13.00	2.1
09/09/10	20:35:09	14.12	5.58	12.80	1.7
09/09/10	20:36:16	14.11	5.59	12.80	2.2
09/09/10	20:37:09	13.70	5.92	13.70	1.7
09/09/10	20:38:16	13.65	5.99	13.35	2.1
09/09/10	20:39:09	13.91	5.79	13.40	1.7
09/09/10	20:40:16	14.80	5.07	11.50	1.8
09/09/10	20:41:09	14.73	5.06	11.00	3.9
09/09/10	20:42:16	14.66	5.51	12.40	2.1
09/09/10	20:43:09	13.68	5.97	13.80	1.7
09/09/10	20:44:16	13.81	5.35	13.35	2.2
09/09/10	20:45:09	14.49	5.27	11.70	5.5
09/09/10	20:46:09	14.25	5.46	12.20	2.9
09/09/10	20:47:09	14.18	5.52	12.40	1.6
09/09/10	20:48:09	14.12	5.57	12.40	1.6
	Average	14.03	5.65	13.03	2.2

# Total Air Analysis Data Acquisition

Santa Maria Flare Run #1

Date	Time	RM O2 (%) O2 %	RM CO2 (%) CO2 %	RM NOx (ppm) NOX	RM CO (ppm) CO #2
09/09/10	14:42:19	14.47	5.24	12.3	6.4
09/09/10	14:43:12	14.13	5.54	13.2	4
09/09/10	14:44:19	14.08	5.55	13.3	4
09/09/10	14:45:12	13.8	5.82	14	4
09/09/10	14:46:19	13.9	5.71	13.8	4
09/09/10	14:47:12	13.9	5.72	13.8	4.1
09/09/10	14:48:19	13.98	5.67	13.8	4.1
09/09/10	14:49:12	13.67	5.94	14.5	4.2
09/09/10	14:50:18	13.97	5.65	13.7	4.1
09/09/10	14:51:12	13.88	5.73	13.9	4.2
09/09/10	14:52:19	13.95	5.67	13.7	4.1
09/09/10	14:53:12	13.89	5.73	13.9	4.1
09/09/10	14:54:19	13.85	5.72	13.8	4.2
09/09/10	14:55:12	13.83	5.78	14	4.2
09/09/10	14:56:18	13.9	5.72	13.8	4.2
09/09/10	14:57:12	13.85	5.76	14	4.2
09/09/10	14:58:18	13.74	5.86	14.2	4.1
09/09/10	14:59:12	13.94	5.67	13.7	4.2
09/09/10	15:00:12	13.98	5.61	13.5	4.2
09/09/10	15:01:12	13.76	5.91	14.9	4.3
09/09/10	15:02:18	14.14	5.51	13.2	4.2
09/09/10	15:03:12	14.43	5.26	12.4	4.3
09/09/10	15:04:18	14.51	5.19	12.2	4.1
09/09/10	15:05:12	14.59	5.14	12.2	4.2
09/09/10	15:06:12	14.37	5.31	12.6	4.3
09/09/10	15:07:12	13.82	5.66	13.4	4.3
09/09/10	15:08:12	13.99	5.68	14	4.4
09/09/10	15:09:12	14.56	5.17	12.5	4.4

09/09/10	15:10:12	14.38	5.28	12.6	4.4
09/09/10	15:11:12	13.11	6.49	16.3	4.4
09/09/10	15:12:12	14.35	5.34	12.7	4.2
09/09/10	15:13:12	14.91	4.87	11.3	4.3
09/09/10	15:14:18	11.98	7.33	18.1	4.4
09/09/10	15:15:12	14.4	5.3	12.6	4.3
09/09/10	15:16:18	14.26	5.38	12.8	4.4
09/09/10	15:17:12	14	5.59	13.3	4.4
09/09/10	15:18:12	13.88	5.73	13.8	4.4
09/09/10	15:19:12	13.84	5.77	13.9	4.3
09/09/10	15:20:12	14	5.66	13.6	4.4
09/09/10	15:21:12	13.88	5.72	13.8	4.4
09/09/10	15:22:12	14.01	5.64	13.7	4.4
09/09/10	15:23:12	13.84	5.76	14	4.4
09/09/10	15:24:12	13.98	5.62	13.6	4.3
09/09/10	15:25:12	14.07	5.57	13.5	4.3
09/09/10	15:26:12	13.76	5.83	14.2	4.3
09/09/10	15:27:12	13.88	5.75	14	4.3
09/09/10	15:28:12	13.79	5.78	14.1	4.3
09/09/10	15:29:12	13.8	5.81	14.1	4.4
09/09/10	15:30:12	14.1	5.54	13.3	4.3
09/09/10	15:31:12	14.24	5.4	12.9	4.3
09/09/10	15:32:12	14.01	5.6	13.6	4.4
09/09/10	15:33:12	13.74	5.86	14.3	4.4
09/09/10	15:34:18	13.96	5.65	13.6	4.4
09/09/10	15:35:12	13.77	5.84	14.2	4.3
09/09/10	15:36:18	13.88	5.75	13.9	4.3
09/09/10	15:37:12	13.9	5.68	13.7	4.4
09/09/10	15:38:12	13.28	6.28	15.7	4.3
09/09/10	15:39:12	14.29	5.38	13.1	4.3
09/09/10	15:40:12	14.4	5.31	12.7	4.3
09/09/10	15:41:12	14.11	5.53	13.2	4.4
09/09/10	15:42:12	14	5.62	13.6	4.3
09/09/10	15:43:12	13.99	5.64	13.6	4.4
09/09/10	15:44:18	13.91	5.72	13.9	4.3

09/09/10	15:45:12	13.7	5.91	14.5	4.3
09/09/10	15:46:12	12.27	7.01	17.2	4.4
09/09/10	15:47:12	14.15	5.55	13.7	4.4
09/09/10	15:48:12	14.78	4.97	11.8	4.9
09/09/10	15:49:12	14.5	5.2	12.3	4.3
09/09/10	15:50:18	13.25	5.32	12.9	4.3
09/09/10	15:51:12	14.22	5.42	13.2	4.3
09/09/10	15:52:12	14.29	5.35	12.8	4.4
09/09/10	15:53:12	14.14	5.51	13.2	4.4
09/09/10	15:54:12	14.03	5.59	13.4	4.4
09/09/10	15:55:12	14.27	5.37	12.8	4.4
09/09/10	15:56:18	13.89	5.86	13.5	4.3
09/09/10	15:57:12	13.66	5.92	14.5	4.4
09/09/10	15:58:18	13.89	5.72	13.9	4.4
09/09/10	15:59:12	13.74	5.84	14.3	4.2
09/09/10	16:00:18	13.91	5.7	13.9	4.4
09/09/10	16:01:12	13.85	5.75	13.9	4.3
09/09/10	16:02:18	13.71	5.82	14	4.4
09/09/10	16:03:12	13.98	5.69	14.3	4.3
09/09/10	16:04:18	14.56	5.14	12.3	5.4
09/09/10	16:05:12	14.08	5.55	13.3	4.5
09/09/10	16:06:18	14.04	5.6	13.6	4.4
09/09/10	16:07:12	14.09	5.46	12.8	4.4
09/09/10	16:08:12	14.09	5.47	12	4.2
09/09/10	16:09:12	14.89	5.02	11.6	4.4
	<b>Average</b>	<b>13.98</b>	<b>5.63</b>	<b>13.58</b>	<b>4.34</b>

09/09/10	16:10:12	1.16	0.15	21.3	4.4
09/09/10	16:11:12	0.14	0.04	22.8	4.5
09/09/10	16:12:18	0.13	0	0	0
09/09/10	16:13:12	0.14	0.03	22.7	4.3
09/09/10	16:14:18	0.11	0.03	22.7	4.3
09/09/10	16:15:12	0.11	0.03	22.7	4.1
09/09/10	16:16:18	1.87	0.8	21.2	4.1

Cals.

09/09/10	16:17:12	9.02	9.04	0.2	4
09/09/10	16:18:12	9.03	9.07	0.1	3.8
09/09/10	16:19:12	9.03	9.07	0.1	3.8
09/09/10	16:21:54	7.2	7.38	0.1	3.7
09/09/10	16:21:54	0.1	0.05	0.1	84.2
09/09/10	16:22:12	0.11	0.04	0.1	84.7
09/09/10	16:23:12	0.1	0.04	0.1	84.4
09/09/10	16:25:54	0.09	0.03	0.1	84.7
09/09/10	16:25:54	0.08	0.05	0.4	84.8
09/09/10	16:27:53	0.08	0.05	0.5	85
09/09/10	16:27:54	2.82	0.06	0.8	70.9



Leak Check 0.00 @ 25" Hg Vx

OX - 41.6, 23.64 ppmv

ID - 87.4, 40%

CO2 - 222 / 8.35%

CO2 - 9.06 / 9.17%

NO2 - 19.24 ppmv

SANTA MARIA LANDFILL

FLARE

Total Air Analysis, Inc  
*[Signature]*

MO	DATE	TIME	DEPTH	TEMP	WIND	WIND DIR	REL HUM	BAROM	WAVE	SEA	SKY	WEATHER	REMARKS
01	09	13:30	10	55.00	0.00	0.00	100	1013.00	0.00	0.00	0.00	0.00	
01	09	13:30	20	55.00	0.00	0.00	100	1013.00	0.00	0.00	0.00	0.00	
01	09	13:30	30	55.00	0.00	0.00	100	1013.00	0.00	0.00	0.00	0.00	
01	09	13:30	40	55.00	0.00	0.00	100	1013.00	0.00	0.00	0.00	0.00	
01	09	13:30	50	55.00	0.00	0.00	100	1013.00	0.00	0.00	0.00	0.00	
01	09	13:30	60	55.00	0.00	0.00	100	1013.00	0.00	0.00	0.00	0.00	
01	09	13:30	70	55.00	0.00	0.00	100	1013.00	0.00	0.00	0.00	0.00	
01	09	13:30	80	55.00	0.00	0.00	100	1013.00	0.00	0.00	0.00	0.00	
01	09	13:30	90	55.00	0.00	0.00	100	1013.00	0.00	0.00	0.00	0.00	
01	09	13:30	100	55.00	0.00	0.00	100	1013.00	0.00	0.00	0.00	0.00	

Time	CO #2	NOX	CO #2	NOX	CO #2	NOX	CO #2	NOX
10	31.42	0.00	31.42	0.00	31.42	0.00	31.42	0.00
20	31.42	0.00	31.42	0.00	31.42	0.00	31.42	0.00
30	31.42	0.00	31.42	0.00	31.42	0.00	31.42	0.00
40	31.42	0.00	31.42	0.00	31.42	0.00	31.42	0.00
50	31.42	0.00	31.42	0.00	31.42	0.00	31.42	0.00
60	31.42	0.00	31.42	0.00	31.42	0.00	31.42	0.00
70	31.42	0.00	31.42	0.00	31.42	0.00	31.42	0.00
80	31.42	0.00	31.42	0.00	31.42	0.00	31.42	0.00
90	31.42	0.00	31.42	0.00	31.42	0.00	31.42	0.00
100	31.42	0.00	31.42	0.00	31.42	0.00	31.42	0.00
110	31.42	0.00	31.42	0.00	31.42	0.00	31.42	0.00
120	31.42	0.00	31.42	0.00	31.42	0.00	31.42	0.00
130	31.42	0.00	31.42	0.00	31.42	0.00	31.42	0.00
140	31.42	0.00	31.42	0.00	31.42	0.00	31.42	0.00
150	31.42	0.00	31.42	0.00	31.42	0.00	31.42	0.00
160	31.42	0.00	31.42	0.00	31.42	0.00	31.42	0.00
170	31.42	0.00	31.42	0.00	31.42	0.00	31.42	0.00
180	31.42	0.00	31.42	0.00	31.42	0.00	31.42	0.00
190	31.42	0.00	31.42	0.00	31.42	0.00	31.42	0.00
200	31.42	0.00	31.42	0.00	31.42	0.00	31.42	0.00
210	31.42	0.00	31.42	0.00	31.42	0.00	31.42	0.00
220	31.42	0.00	31.42	0.00	31.42	0.00	31.42	0.00
230	31.42	0.00	31.42	0.00	31.42	0.00	31.42	0.00
240	31.42	0.00	31.42	0.00	31.42	0.00	31.42	0.00
250	31.42	0.00	31.42	0.00	31.42	0.00	31.42	0.00
260	31.42	0.00	31.42	0.00	31.42	0.00	31.42	0.00
270	31.42	0.00	31.42	0.00	31.42	0.00	31.42	0.00
280	31.42	0.00	31.42	0.00	31.42	0.00	31.42	0.00
290	31.42	0.00	31.42	0.00	31.42	0.00	31.42	0.00
300	31.42	0.00	31.42	0.00	31.42	0.00	31.42	0.00
310	31.42	0.00	31.42	0.00	31.42	0.00	31.42	0.00
320	31.42	0.00	31.42	0.00	31.42	0.00	31.42	0.00
330	31.42	0.00	31.42	0.00	31.42	0.00	31.42	0.00
340	31.42	0.00	31.42	0.00	31.42	0.00	31.42	0.00
350	31.42	0.00	31.42	0.00	31.42	0.00	31.42	0.00
360	31.42	0.00	31.42	0.00	31.42	0.00	31.42	0.00
370	31.42	0.00	31.42	0.00	31.42	0.00	31.42	0.00
380	31.42	0.00	31.42	0.00	31.42	0.00	31.42	0.00
390	31.42	0.00	31.42	0.00	31.42	0.00	31.42	0.00
400	31.42	0.00	31.42	0.00	31.42	0.00	31.42	0.00
410	31.42	0.00	31.42	0.00	31.42	0.00	31.42	0.00
420	31.42	0.00	31.42	0.00	31.42	0.00	31.42	0.00
430	31.42	0.00	31.42	0.00	31.42	0.00	31.42	0.00
440	31.42	0.00	31.42	0.00	31.42	0.00	31.42	0.00
450	31.42	0.00	31.42	0.00	31.42	0.00	31.42	0.00
460	31.42	0.00	31.42	0.00	31.42	0.00	31.42	0.00
470	31.42	0.00	31.42	0.00	31.42	0.00	31.42	0.00
480	31.42	0.00	31.42	0.00	31.42	0.00	31.42	0.00
490	31.42	0.00	31.42	0.00	31.42	0.00	31.42	0.00
500	31.42	0.00	31.42	0.00	31.42	0.00	31.42	0.00

O<sub>2</sub>/CO<sub>2</sub> Sys

CO Sys

17.6 - 0.2 x 100  
19.24 = 91.5%

No more

NO<sub>2</sub> (19.24)

Spans

Direct Zeros

Leak Check 0.00 @ 25" Hg Vc

Total Air Analysis, Inc  
Kruppa

NOx - 416, 23.64 ppm  
CO - 4.44 ppm



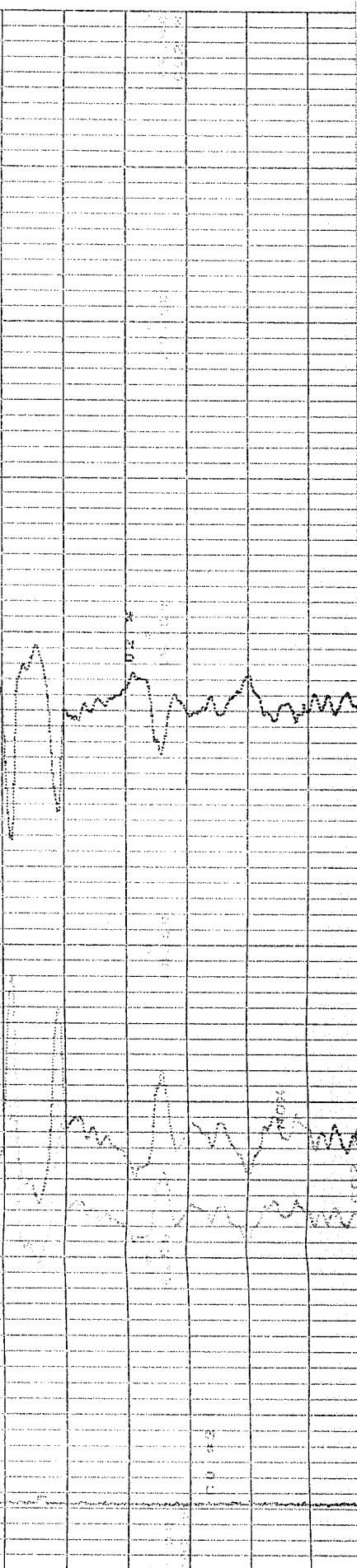
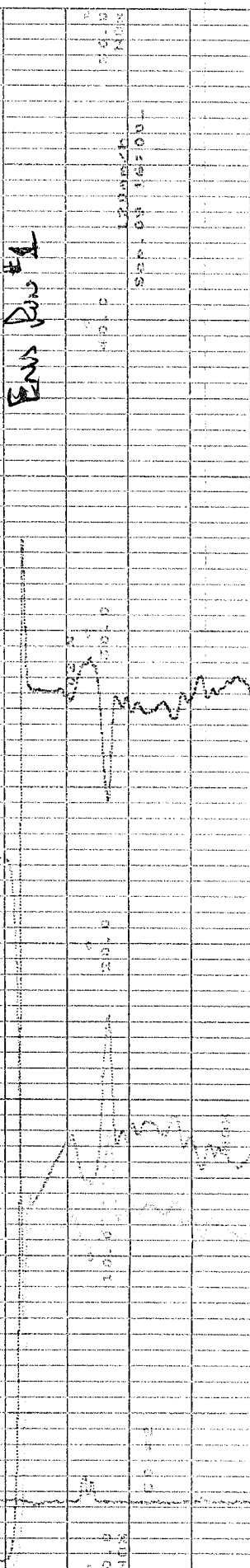
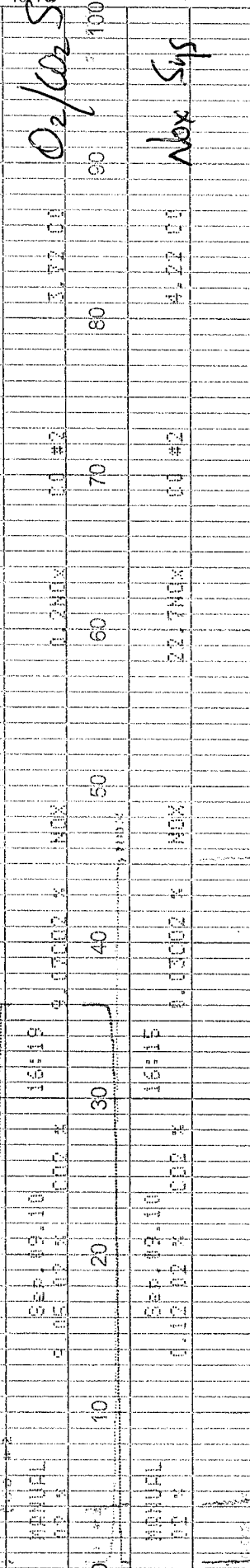
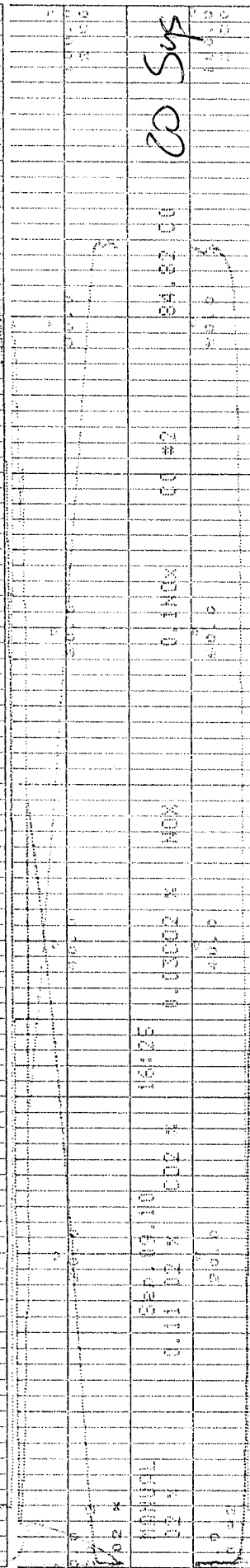
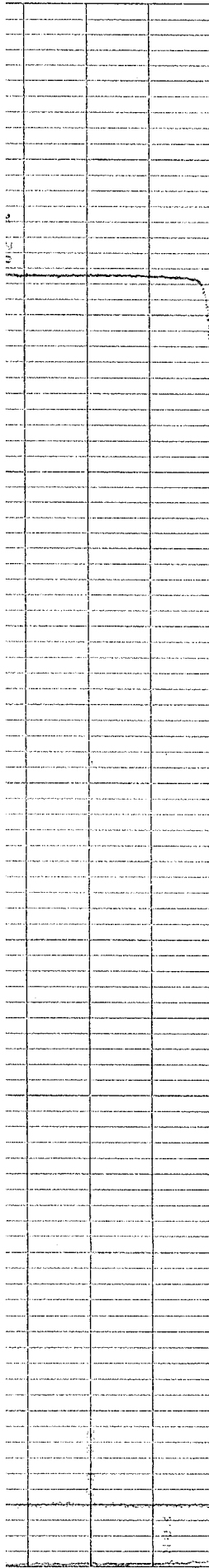

13772  
O2/CO2 Sys

ENS Run #1

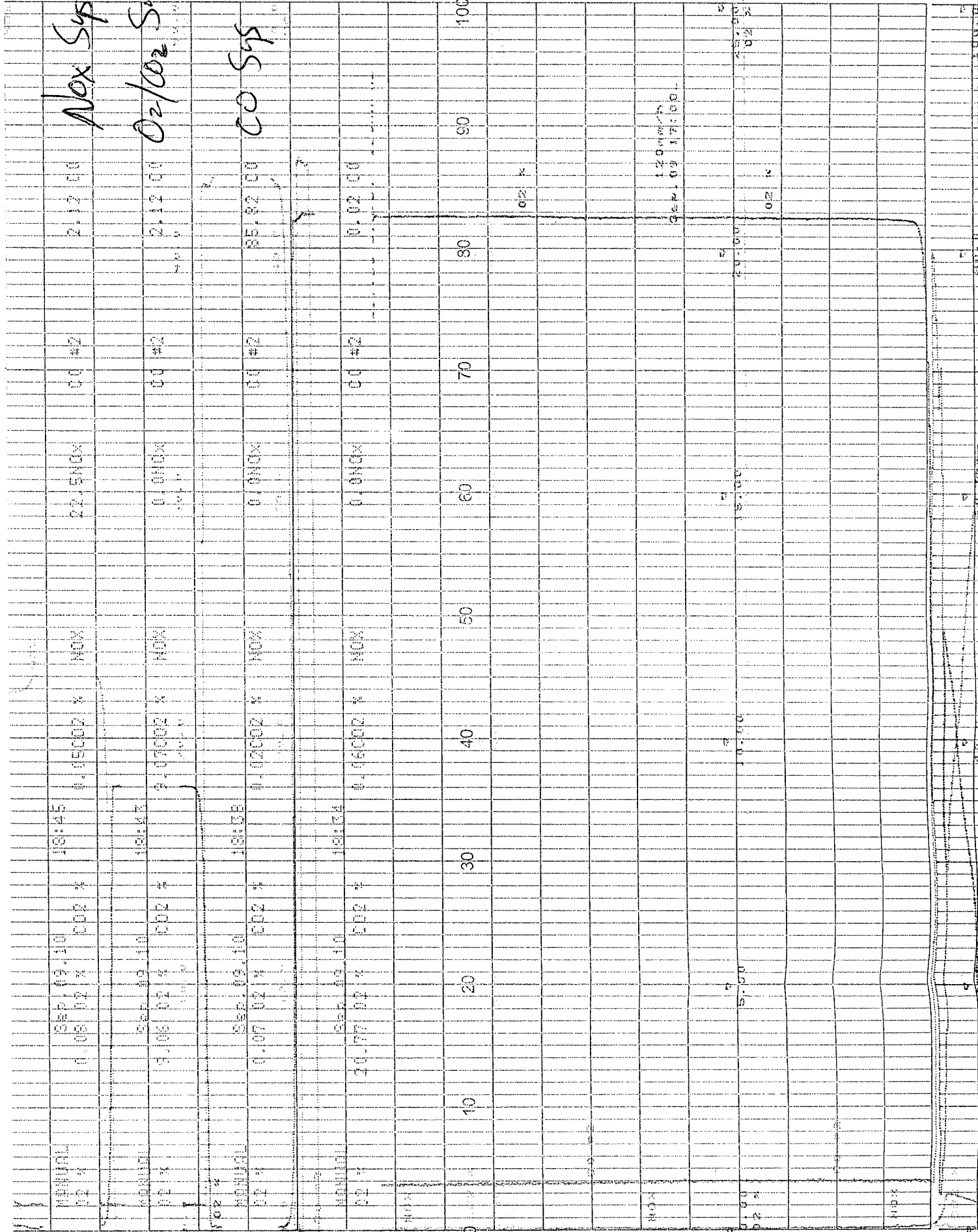

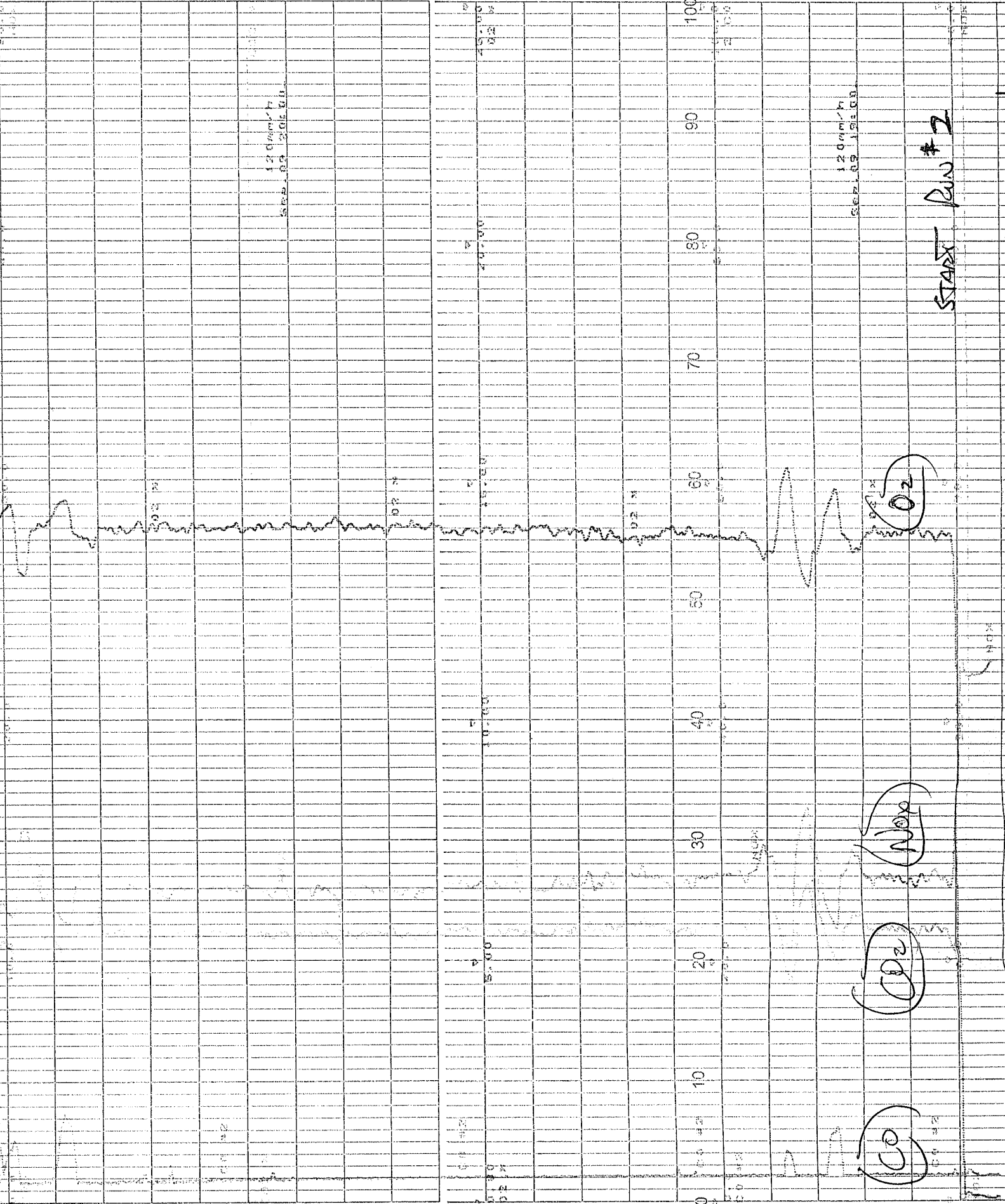

Spans

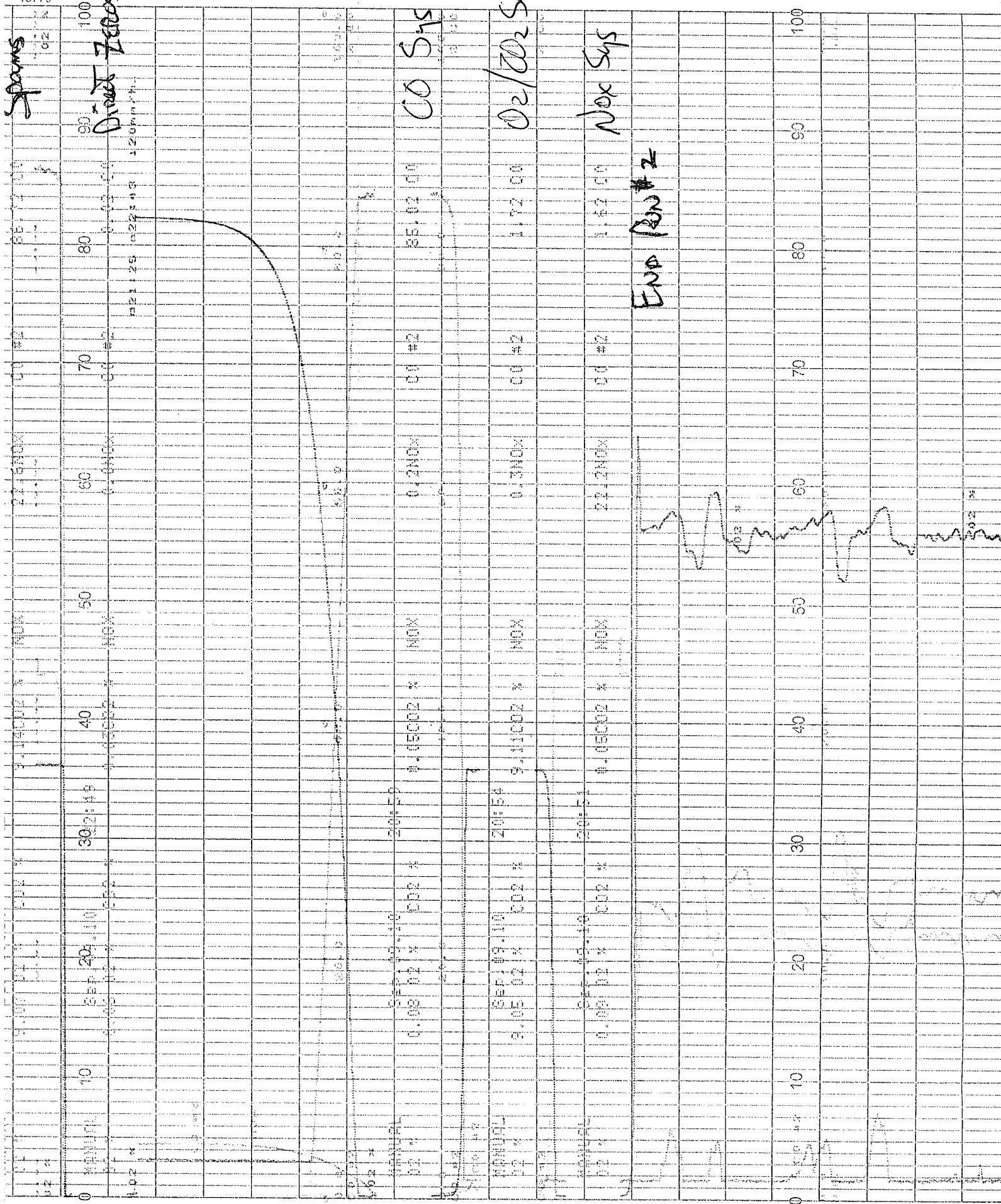

END RUN #2

CO Sys

O2/O2 Sys

NOx Sys

CO2

CO2

No 7.7-0.1 x 100  
= 910

NOV 10	20.64	02	NOV	0.13NOX	00 #2	4.12	00
NOV 10	20.64	02	NOV	17.7NOX	00 #2	3.72	00
NOV 10	22.16	02	NOV	18.7NOX	00 #2	3.77	54
NOV 10	22.16	02	NOV	4.62NOX	070 #2	827.62	00 90
NOV 10	22.16	02	NOV	42.7NOX	00 #2	87.72	00

Direct Zeros

Leak Check D.O @ 25" H6 VAC

NOV 10	20.64	02	NOV	14.100	00 #2	20.00	00
NOV 10	20.64	02	NOV	15.00	00 #2	20.00	00
NOV 10	20.64	02	NOV	14.2NOX	00 #2	20.00	00
NOV 10	20.64	02	NOV	15.00	00 #2	20.00	00
NOV 10	20.64	02	NOV	14.100	00 #2	20.00	00
NOV 10	20.64	02	NOV	14.100	00 #2	20.00	00
NOV 10	20.64	02	NOV	14.100	00 #2	20.00	00
NOV 10	20.64	02	NOV	14.100	00 #2	20.00	00
NOV 10	20.64	02	NOV	14.100	00 #2	20.00	00

MAINS

Spans

Direct Zeros



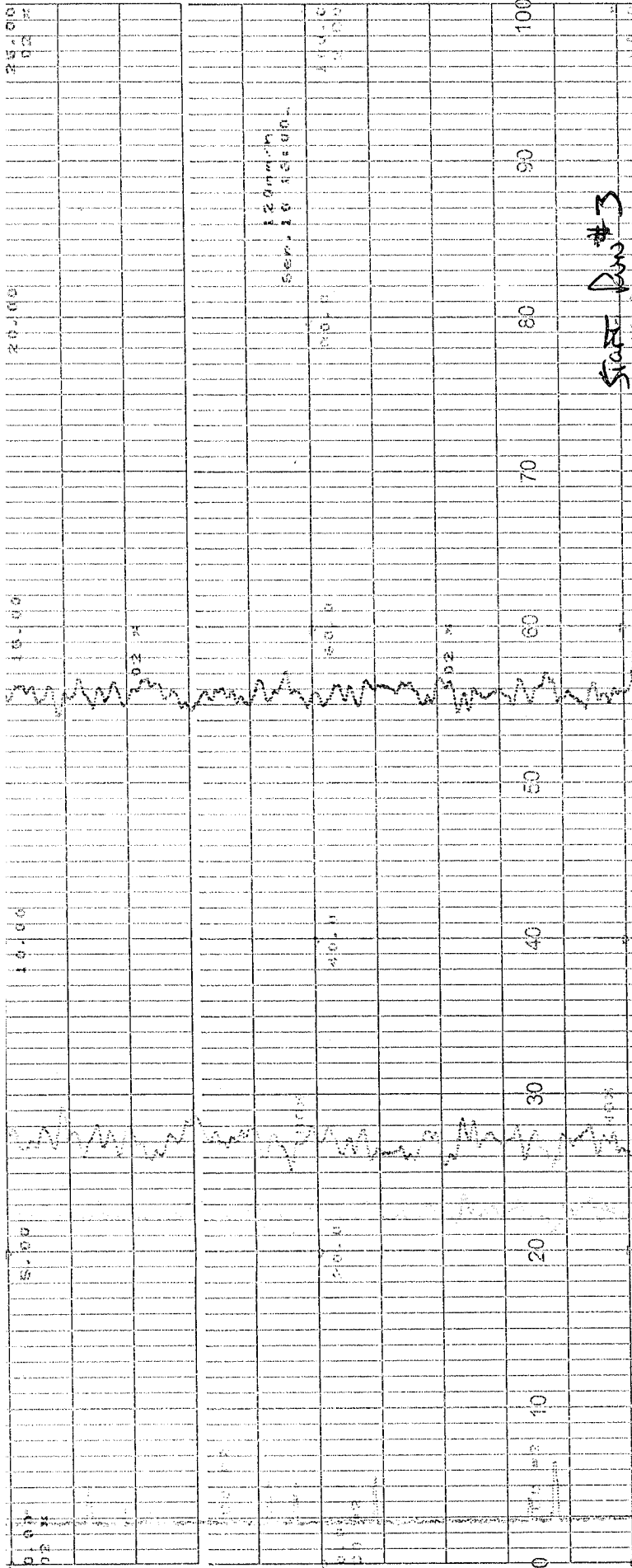

STATE Run #3

NOx Sys

Oz/CO2 Sys

CO Sys

NOx Min

NOx Max

Time	CO2 %	NOx	CO Sys	NOx Min	NOx Max
15:28	0.02002 %	NOX	0.00000 %	0.00000 %	0.00000 %
15:29	0.02002 %	NOX	0.00000 %	0.00000 %	0.00000 %
15:30	0.02002 %	NOX	0.00000 %	0.00000 %	0.00000 %
15:31	0.02002 %	NOX	0.00000 %	0.00000 %	0.00000 %
15:32	0.02002 %	NOX	0.00000 %	0.00000 %	0.00000 %
15:33	0.02002 %	NOX	0.00000 %	0.00000 %	0.00000 %
15:34	0.02002 %	NOX	0.00000 %	0.00000 %	0.00000 %
15:35	0.02002 %	NOX	0.00000 %	0.00000 %	0.00000 %
15:36	0.02002 %	NOX	0.00000 %	0.00000 %	0.00000 %
15:37	0.02002 %	NOX	0.00000 %	0.00000 %	0.00000 %
15:38	0.02002 %	NOX	0.00000 %	0.00000 %	0.00000 %
15:39	0.02002 %	NOX	0.00000 %	0.00000 %	0.00000 %
15:40	0.02002 %	NOX	0.00000 %	0.00000 %	0.00000 %
15:41	0.02002 %	NOX	0.00000 %	0.00000 %	0.00000 %
15:42	0.02002 %	NOX	0.00000 %	0.00000 %	0.00000 %
15:43	0.02002 %	NOX	0.00000 %	0.00000 %	0.00000 %
15:44	0.02002 %	NOX	0.00000 %	0.00000 %	0.00000 %
15:45	0.02002 %	NOX	0.00000 %	0.00000 %	0.00000 %
15:46	0.02002 %	NOX	0.00000 %	0.00000 %	0.00000 %
15:47	0.02002 %	NOX	0.00000 %	0.00000 %	0.00000 %
15:48	0.02002 %	NOX	0.00000 %	0.00000 %	0.00000 %
15:49	0.02002 %	NOX	0.00000 %	0.00000 %	0.00000 %
15:50	0.02002 %	NOX	0.00000 %	0.00000 %	0.00000 %
15:51	0.02002 %	NOX	0.00000 %	0.00000 %	0.00000 %
15:52	0.02002 %	NOX	0.00000 %	0.00000 %	0.00000 %
15:53	0.02002 %	NOX	0.00000 %	0.00000 %	0.00000 %
15:54	0.02002 %	NOX	0.00000 %	0.00000 %	0.00000 %
15:55	0.02002 %	NOX	0.00000 %	0.00000 %	0.00000 %
15:56	0.02002 %	NOX	0.00000 %	0.00000 %	0.00000 %
15:57	0.02002 %	NOX	0.00000 %	0.00000 %	0.00000 %
15:58	0.02002 %	NOX	0.00000 %	0.00000 %	0.00000 %
15:59	0.02002 %	NOX	0.00000 %	0.00000 %	0.00000 %
16:00	0.02002 %	NOX	0.00000 %	0.00000 %	0.00000 %

100

23.3NOX

NO

0.1NOX

17.7NOX

3.72 CO

4.52 CO

4.17 CO

3.72 CO

NO

17.7NOX

3.72 CO

NO

4.17 CO

4.52 CO

3.72 CO

NO

17.7NOX

3.72 CO

NO

4.17 CO

4.52 CO

3.72 CO

De/Co2 Sys

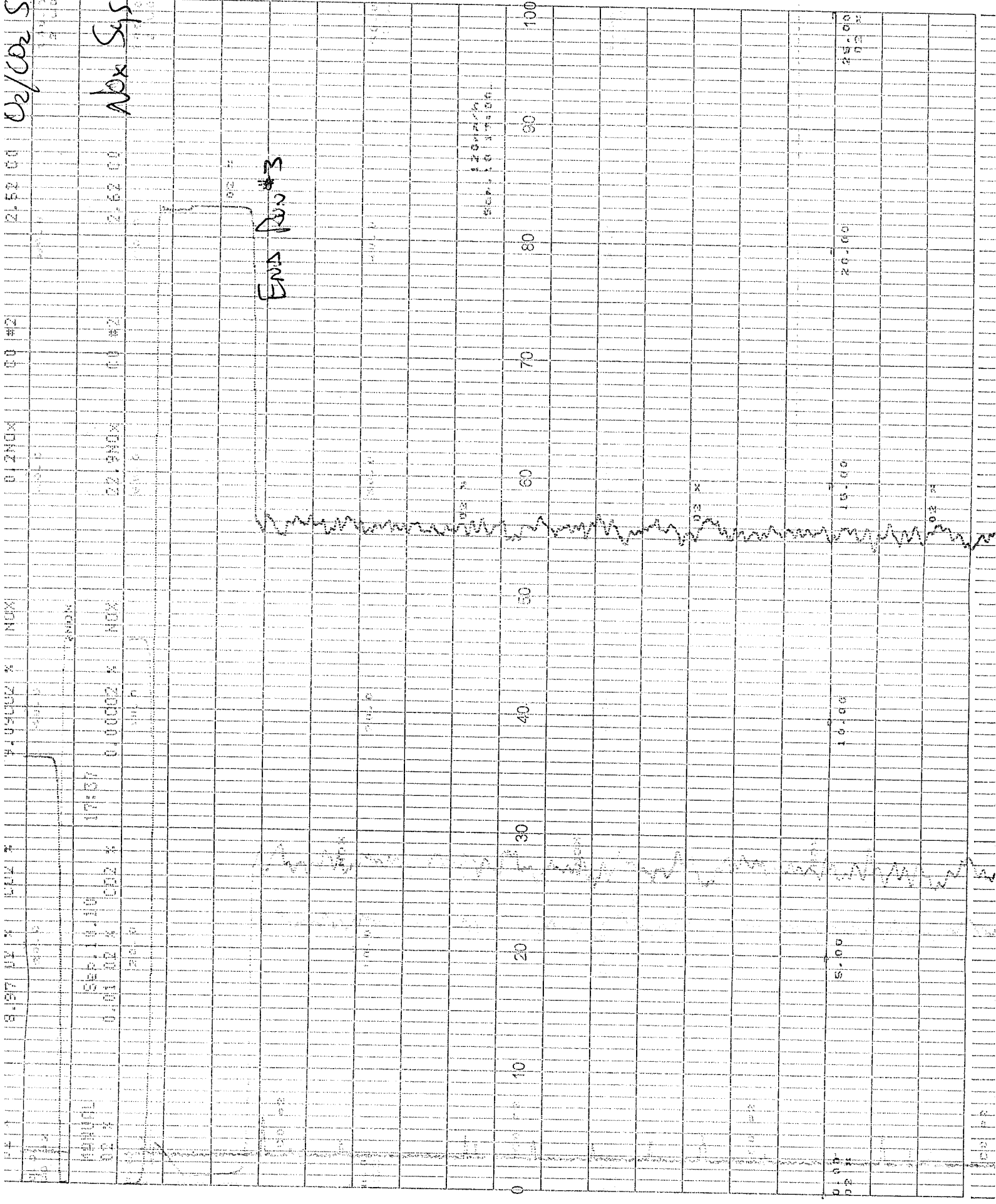



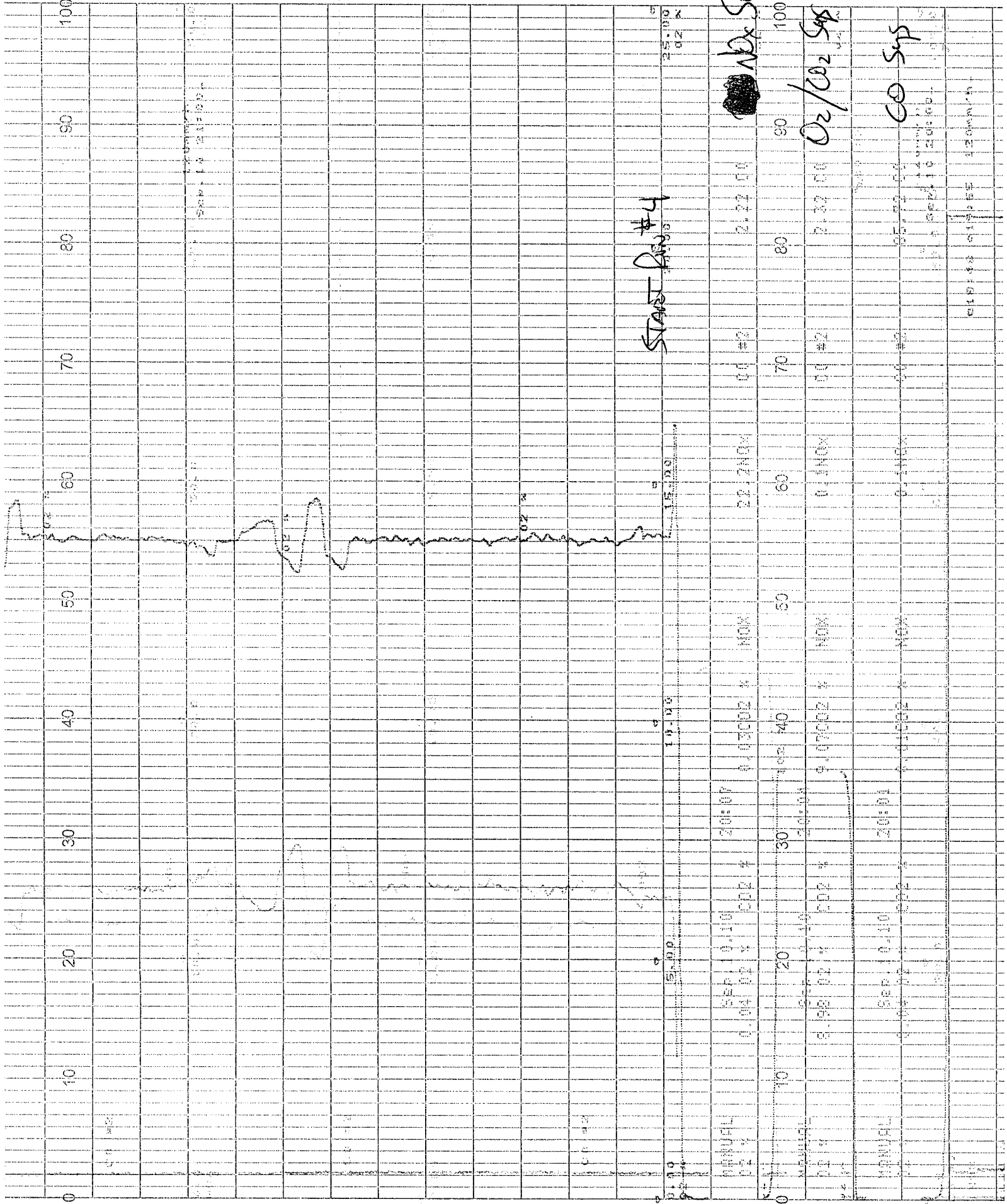

PERIODIC REPORT

02 SEP 10 22:00

0 10 20 30 40 50 60 70 80 90 100

ANIDS

SPNS

ZEROS

CO Sps

O2/CO2 Sps

NOx Sps

END RUN #4

0 10 20 30 40 50 60 70 80 90 100

9/13/10  
 8770

MANUAL	SEP 11 10	11:06	0.0NOX	00 #2	2.32 04	O <sub>2</sub> /CO <sub>2</sub> Sys
MANUAL	SEP 11 10	11:02	0.0NOX	00 #2	85.72 00	CO Sys
MANUAL	SEP 11 10	11:00	0.0NOX	00 #2	0.32 00	NO <sub>2</sub>
MANUAL	SEP 11 10	10:58	0.20NOX	00 #2	0.32 00	NO <sub>2</sub>
MANUAL	SEP 11 10	10:57	0.16NOX	00 #2	04.72 00	MANIDS
MANUAL	SEP 11 10	10:57	0.30NOX	00 #2	87.42 00	Spans
MANUAL	SEP 11 10	10:47	0.06NOX	00 #2	0.02 00	Zeros
Lent Check 0.00 @ 25" H6 VAC.						
SATURDAY - Santa Maria Flare						



(O2)

(CO2)

(NOx)

(O2)

START RUN #5

NOx Sys

O2/CO2 Sys

CO Sys





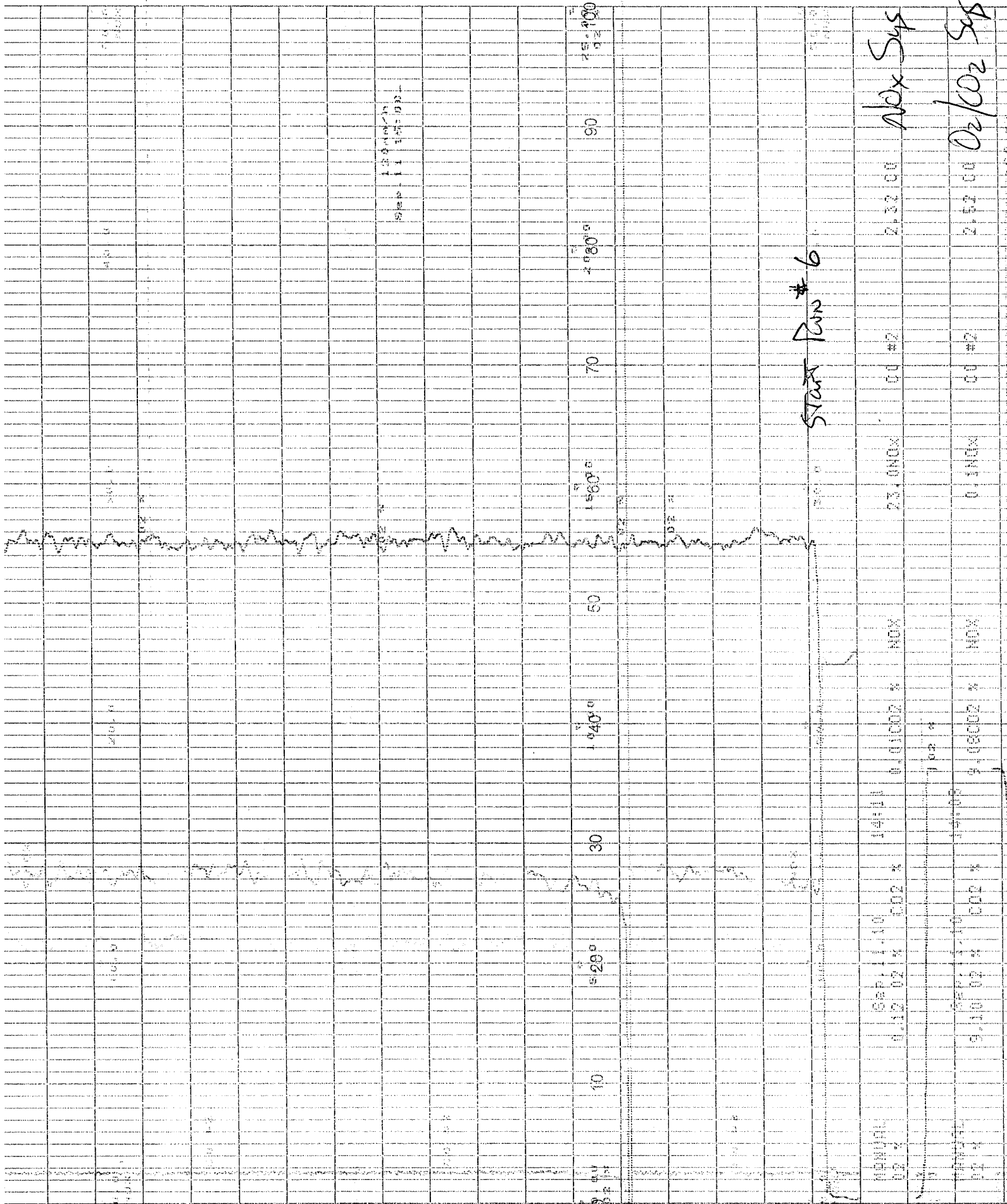

SEP 11 11:55:19.22

START Run # 6

TIME	CO2 %	NOX %	CO2 #2	NOX #2	ADJ Sys
SEP 11 14:11	0.1202 %	0.0002 %	00 #2	2.32 00	ADJ Sys
SEP 11 14:02	0.1102 %	0.0002 %	00 #2	2.52 00	O2/CO2 Sys



**Appendix B**

***CARB Method 425 – Hexavalent Chrome***  
**Calculation Spreadsheets, Analytical Results, and Field Data Sheets**

## CARB METHOD 425 - Hexavalent Chrome

Facility: Santa Maria Landfill      End Date: 9/11/2010  
 Source: Flare                              Operator: JDG  
 Load: Normal  
 Start Date: 9/10/2010

Data Entry	Symbol	Units	Run 1	Run 2	Run 3
Round Stack, Diameter	D	inches	55.0	55.0	55.0
Rectangular Stack, Length	L	inches			
	W	inches			
Nozzle Diameter	Dn	inches	0.750	0.750	0.750
Stack Temperature	Ts	degrees F	1355.0	1356.0	1349.1
Meter Temperature	Tm	degrees F	63.9	74.2	75.6
Barometric Pressure	Pbar	in. Hg	29.97	29.98	29.98
Stack Static Pressure	Pg	in. H <sub>2</sub> O	-0.01	-0.01	-0.01
Delta H	dH	in. H <sub>2</sub> O	1.500	1.500	1.488
Velocity Head (Delta P)	dP	in. H <sub>2</sub> O	0.010	0.010	0.010
Pitot Coefficient	Cp	-	0.99	0.99	0.99
Sample Volume	Vm	cubic ft.	78.24	79.04	80.10
Meter Factor	Y	-	0.9969	0.9969	0.9969
Sampling Time	min	minutes	120	120	120
Oxygen Content	%O <sub>2</sub> ,m	%	13.84	13.88	13.89
Carbon Dioxide Content	%CO <sub>2</sub> ,m	%	5.71	5.57	5.52
Impinger Gain	Ww	grams	129.6	135.1	138.1

Hex. Chrome, Impingers	ug	ug/Sample	0.0507	0.0698	0.0411
Hex. Chrome, Rinse	ug	ug/Sample	0.0140	0.0122	0.0116
Hex. Chrome, Total	ug	ug/Sample	0.0647	0.0820	0.0527

# CARB METHOD 425 - Hexavalent Chrome

Facility: Santa Maria Landfill  
 Source: Flare

Calculated Data	Symbol	Units	Run 1	Run 2	Run 3
Nozzle Area, $An = 3.14(dn)^2/4$	An	sq. in.	0.44179	0.44179	0.44179
Stack Area, $As = 3.14(ds)^2/576$ (Round) = L * W/144 (Rectangular)	As	sq. feet	16.50	16.50	16.50
Stack Temperature, $Ts = Fs + 460$	Ts,r	degrees R	1795	1816	1809
Meter Temperature, $Tm = Fm + 460$	Tm,r	degrees R	524	534	536
Sample Volume @ Standard Conditions					
$VmStd = 17.6471 Y (Vm/Tm) (Pbar + dH/13.6)$	VmStd	dscf	79.03	77.14	77.96
Water Vapor Volum, $VwStd = 0.04707 * Ww$	VwStd	dscf	6.10	6.36	6.50
Moisture Fraction, $Bws = VwStd / (VmStd + VwStd)$	Bws	none	0.07	0.08	0.08
Dry Molecular Weight, $Md = 0.32(\%O2,m) + 0.44(\%CO2,m) + 0.28\{100 - (\%O2,m) - (\%CO2,m)\}$	Md	lb/lb-mol	29.47	29.45	29.44
Wet Molecular Weight, $Mw = Md(1-Bws) + 18.0(Bws)$	Mw	lb/lb-mol	28.6	28.6	28.6
Absolute Stack Pressure, $Ps = Pbar + Pg/13.6$	Ps	in. Hg	29.97	29.98	29.98
Gas Velocity $vs = 85.49 Cp \{ \sqrt{[(dp*Ts) / (Ps*Mw)]} \}$	Vs	ft/s	12.2	12.3	12.3
Actual Stack Gas Flowrate, $Q = 60 * vs * As$	Qa	acf/min	12,115	12,199	12,179
Dry Stack Gas Flowrate $Qsd = 17.64 * Q * (1-Bws) * (Ps/Ts)$	Qsd	dscf/min	3,312	3,282	3,286
$Qsdm = Qsd / 35.32$	Qsdm	dscm/min	94	93	93
Isokinetic Rate, $I = 13.81 * Ts * VmStd / [Ps * vs * An * \min(1-Bws)]$	I	%	108.5	106.9	107.9

Concentration					
Hex. Chrome	ug/dscm	0.0289	0.0056	0.0053	
Hex. Chrome	gr/dscf	1.26E-08	2.44E-09	2.30E-09	
Emission Rate					
Hex. Chrome	g/Hr	0.006	0.001	0.001	
Hex. Chrome	lb/hr	3.59E-07	6.86E-08	6.47E-08	

IMPINGER	FINAL WT.	INITIAL WT	NET
1	781	685.2	95.8
2	700.1	678.3	21.8
3	605.7	601.1	4.6
4	913.7	906.3	7.4

**CARB 425, RUN 1**

129.6

	dH	dP	sqrt (dP)	Vm	Ts	Tm, in	Tm, out
1	1.5	0.01	0.1	668.26	1335	66	
2	1.5	0.01	0.1	746.50	1342	65	
3	1.5	0.01	0.1		1329	65	
4	1.5	0.01	0.1		1333	64	
5	1.5	0.01	0.1		1313	64	
6	1.5	0.01	0.1		1340	63	
7	1.5	0.01	0.1		1336	63	
8	1.5	0.01	0.1		1334	63	
9	1.5	0.01	0.1		1339	63	
10	1.5	0.01	0.1		1342	63	
11	1.5	0.01	0.1		1331	63	
12	1.5	0.01	0.1		1343	63	
13	1.5	0.01	0.1		1344	64	
14	1.5	0.01	0.1		1329	65	
15	1.5	0.01	0.1		1324	64	
16	1.5	0.01	0.1		1346	64	
17							
18							
19							
20							
21							
22							
23							
24							

**AVERAGE      1.50      0.010      0.1      78.24      1335      63.9**  
0.01

1	785.3	685.1	100.2
2	685.6	671	14.6
3	605.2	602.7	2.5
4	880	862.2	17.8

**RUN 2**

135.1

	dH	dP	sqrt (dP)	Vm	Ts	Tm, in	Tm, out
1	1.5	0.01	0.1	750.16	1321	74	
2	1.5	0.01	0.1	829.2	1313	74	
3	1.5	0.01	0.1		1322	74	
4	1.5	0.01	0.1		1298	74	
5	1.5	0.01	0.1		1301	74	
6	1.5	0.01	0.1		1336	74	
7	1.5	0.01	0.1		1349	74	
8	1.5	0.01	0.1		1341	74	
9	1.5	0.01	0.1		1399	74	
10	1.5	0.01	0.1		1406	74	
11	1.5	0.01	0.1		1406	74	
12	1.5	0.01	0.1		1409	74	
13	1.5	0.01	0.1		1379	74	
14	1.5	0.01	0.1		1386	75	
15	1.5	0.01	0.1		1396	75	
16	1.5	0.01	0.1		1334	75	
17							
18							
19							
20							
21							
22							
23							
24							

**AVERAGI 1.50 0.010 0.1 79.04 1356 74.2**  
0.01

IMPINGEFINAL WTINITIAL W NET

1	793.8	683.5	110.3
2	681.8	671.2	10.6
3	607.7	605.2	2.5
4	894.7	880	14.7

**CARB 425, RUN 3**

138.1

	dH	dP	sqrt (dP)	Vm	Ts	Tm, in	Tm, out
1	1.4	0.01	0.1	830.4	1386	75	
2	1.4	0.01	0.1	910.5	1402	75	
3	1.5	0.01	0.1		1389	75	
4	1.5	0.01	0.1		1406	75	
5	1.5	0.01	0.1		1369	75	
6	1.5	0.01	0.1		1346	75	
7	1.5	0.01	0.1		1348	76	
8	1.5	0.01	0.1		1289	76	
9	1.5	0.01	0.1		1331	76	
10	1.5	0.01	0.1		1341	76	
11	1.5	0.01	0.1		1351	76	
12	1.5	0.01	0.1		1342	76	
13	1.5	0.01	0.1		1340	76	
14	1.5	0.01	0.1		1329	76	
15	1.5	0.01	0.1		1313	76	
16	1.5	0.01	0.1		1303	76	
17							
18							
19							
20							
21							
22							
23							
24							

**AVERAGE** 1.49 0.01 0.1 80.10 1349.06 75.6  
0.01



<b>CLIENT</b>	<b>Total Air Analysis, Inc.</b>
<b>CLIENT PROJ NO:</b>	<b>JA-100887</b>
<b>LABORATORY NO:</b>	<b>10-744</b>
<b>SAMPLING DATE:</b>	September 10 & 11, 2010
<b>RECEIVING DATE:</b>	September 16, 2010
<b>ANALYSIS DATE:</b>	September 20, 2010
<b>REPORT DATE:</b>	September 22, 2010

### Laboratory Results

Analysis Method	CARB 425		
Detection Limits	0.2 ng/ml		
Sample ID	Volume	Cr6+	Cr6+
Description	(ml)	ng/ml	ng/Sample
Run 1 - Imp	286	0.18	50.7
Run 1 - Rinse	75	0.19	14.0
Run 2 - Imp	281	0.25	69.8
Run 2 - Rinse	75	0.16	12.2
Run 3 - Imp	288	0.14	41.1
Run 3 - Rinse	75	0.15	11.6
Field Blank - Imp	152	0.14	21.0
Field Blank - Rinse	75	0.16	11.7
Reagent Blank	75	0.13	9.6

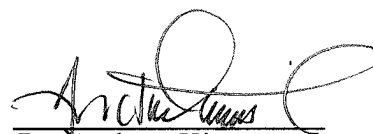

Dr. Andrew Kitto  
 President

**CLIENT** Total Air Analysis, Inc.  
**CLIENT PROJ NO:** JA-100887  
**LABORATORY NO:** 10-744  
**SAMPLING DATE:** September 10 & 11, 2010  
**RECEIVING DATE:** September 16, 2010  
**ANALYSIS DATE:** September 20, 2010  
**REPORT DATE:** September 22, 2010

### Quality Assurance Report

<b>Analysis Method</b>	<b>CARB 039</b>	
<b>Detection Limit</b>	<b>0.5 ng/ml</b>	
<b>Sample ID</b>	<b>Analyte</b>	<b>ng/ml</b>
Initial Blank (IB)	Cr6+	<0.5
Final Blank (FB)	Cr6+	<0.5

### Duplicate Analysis

<b>Sample ID</b>	<b>Analyte</b>	<b>Analysis # 1 ng/ml</b>	<b>Analysis # 2 ng/ml</b>	<b>Mean ng/ml</b>	<b>% Difference from the Mean</b>
<b>Run 3 - Rinse</b>	Cr6+	0.15	0.15	0.15	0.1%



Dr. Andrew Kitto  
President

**CLIENT:** Total Air Analysis, Inc.  
**CLIENT PROJ NO:** JA-100887  
**LABORATORY NO:** 10-744  
**SAMPLING DATE:** September 10 & 11, 2010  
**RECEIVING DATE:** September 16, 2010  
**ANALYSIS DATE:** September 20, 2010  
**REPORT DATE:** September 22, 2010

## Quality Assurance Report

### Standard Verification

Sample ID	Theoretical Value ng/ml	Tested Value ng/ml	% RPD	% Recovery*
CCV 5.0 ng/ml	5.0	4.63	7.4	93%
CCV 50 ng/ml	50	50.71	1.4	101%

\*: Must be between 85-115%



Dr. Andrew Kitto  
President

**Cr+6**

$y = 0.000003861x$   
 $R^2 = 0.999905980$

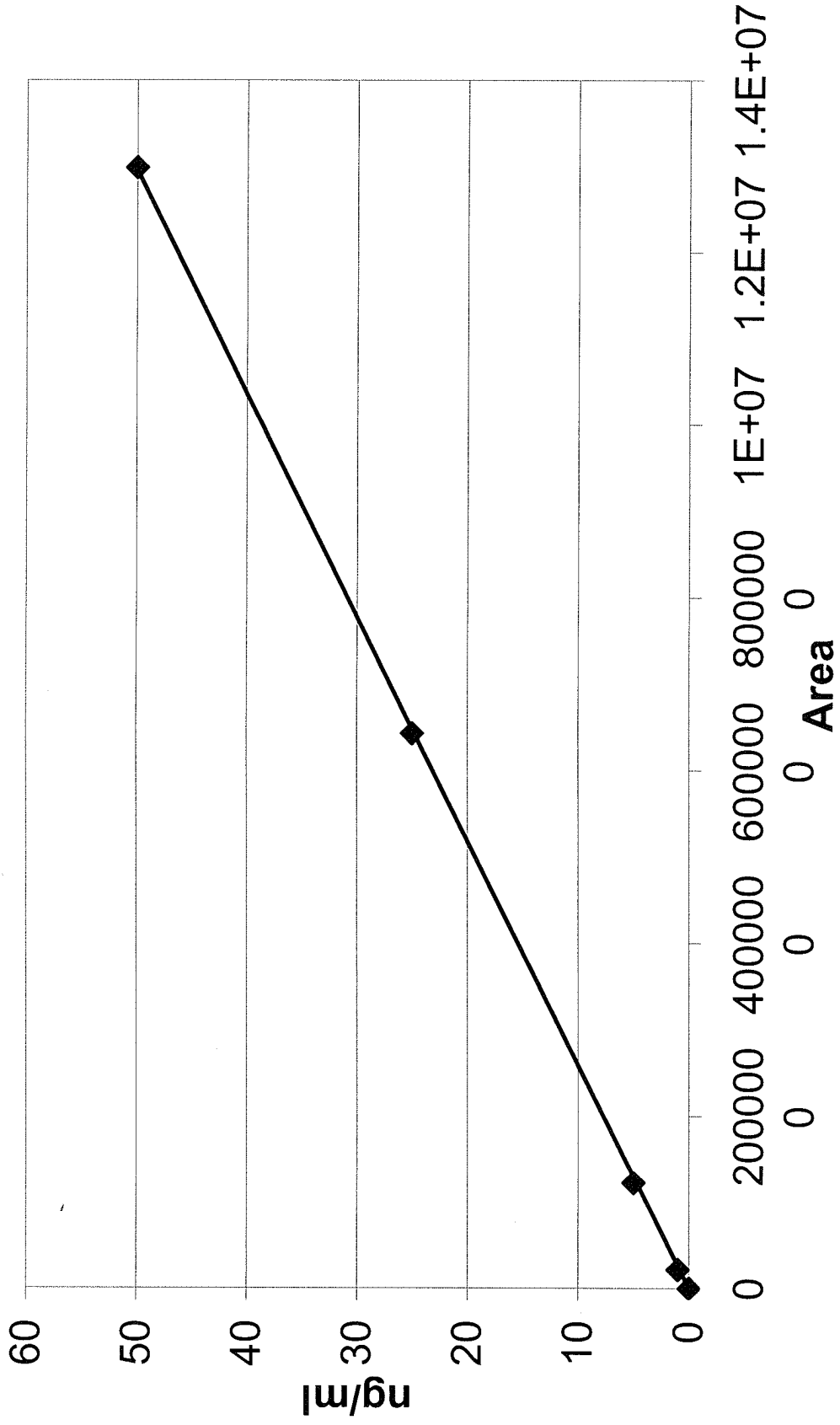

Laboratory: Quantum

10-744

# TOTAL AIR ANALYSIS, INC.

1210 East 223 rd Street, # 314 Carson, CA 90745 (310) 518 5133 Fax: (310) 518 5107

## CHAIN OF CUSTODY

Page: 1 of: 1

Client: <u>Santa Maria</u>		Project No.: <u>SA-100887</u>		Analysis		Turnaround Time:				
Contact Person: <u>Russ Logan</u>		Project Name: <u>Flare</u>		<input type="checkbox"/> Same Day <input type="checkbox"/> 24 Hours <input type="checkbox"/> 48 Hours <input checked="" type="checkbox"/> Normal		<input type="checkbox"/> Same Day <input type="checkbox"/> 24 Hours <input type="checkbox"/> 48 Hours <input checked="" type="checkbox"/> Normal				
tel: _____		Project Manager: <u>RPL</u>								
fax: _____		P.O. Number: _____		(APCS 425) HX Chlorine		O.I.N. NaOH 75mls				
Total Air ID #	Client Sample ID	Summa Canister #	Date					Type of Sample	Lab ID Number	Remarks
	<u>RUN #1 - Imp. Cr 6</u>	<u>-</u>	<u>9/10/10</u>					<u>Liquids</u>	<u>✓</u>	
	<u>" 1 - Rinse Cr 6</u>	<u>-</u>	<u>"</u>						<u>✓</u>	
	<u>RUN #2 - Imp. Cr 6</u>	<u>-</u>	<u>9/11/10</u>						<u>✓</u>	
	<u>" 2 Rinse Cr 6</u>	<u>-</u>							<u>✓</u>	
	<u>RUN #3 - Imp. Cr 6</u>	<u>-</u>							<u>✓</u>	
	<u>" 3 - Rinse Cr 6</u>	<u>-</u>							<u>✓</u>	
	<u>Field Blank - Imp Cr 6</u>	<u>-</u>							<u>✓</u>	
	<u>" Rinse Cr 6</u>	<u>-</u>							<u>✓</u>	
	<u>Reagent Blank (NaOH)</u>	<u>-</u>			<u>✓</u>					
Relinquished by: (signature)		Date/Time		Received by: (signature)		Date/Time				
<u>[Signature]</u>		<u>9/13/10 @ 11:05</u>		<u>[Signature]</u>		<u>9/16/10 12:25</u>				
Relinquished by: (signature)		Date/Time		Received by: (signature)		Date/Time				
<u>[Signature]</u>				<u>[Signature]</u>						

# Sample Analysis Report

Sample Name : BLANK

Data File Name : C:\PEAKNET\DATA\SEP2010\26310-01\_001.DXD

Method File Name : c:\peaknet\method\cr6as708.mct

Date Time Collected : 9/20/2010 1:22:07 PM

System Operator :

Peak Information : All Peaks

Peak #	Component Name	Retention Time	Amount	Peak Area	Peak Height
--------	----------------	----------------	--------	-----------	-------------

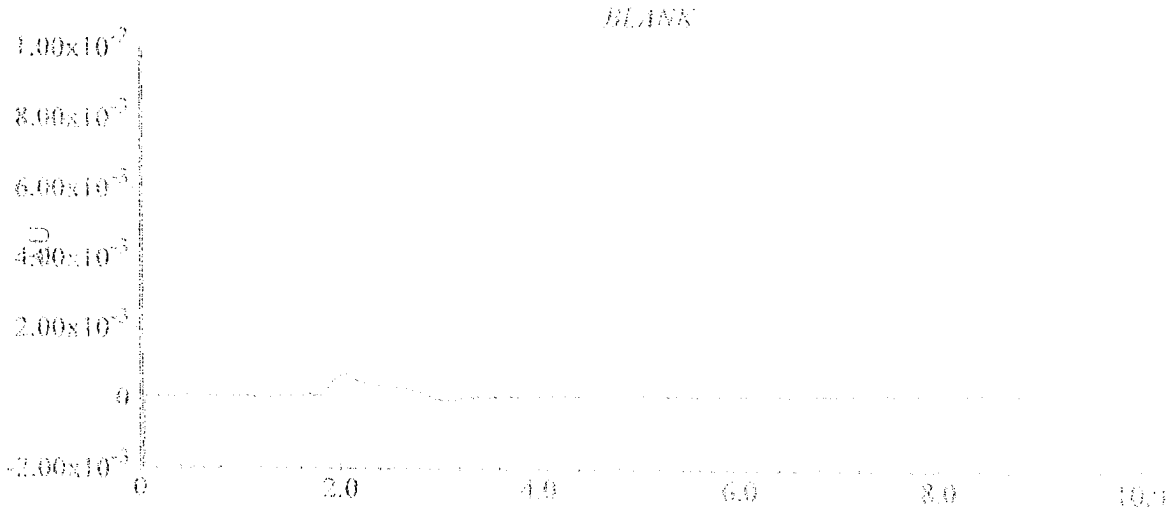

# Sample Analysis Report

Sample Name : 50 ng/mL STD

Data File Name : C:\PEAKNET\DATA\SEP2010\26310-04\_004.DXD

Method File Name : c:\peaknet\method\cr6as708.met

Date/Time Collected : 9/20/2010 2:07:01 PM

System Operator :

## Peak Information : All Peaks

Peak #	Component Name	Retention Time	Amount	Peak Area	Peak Height
1	Hex Chrome	6.27	420	13134681	704291

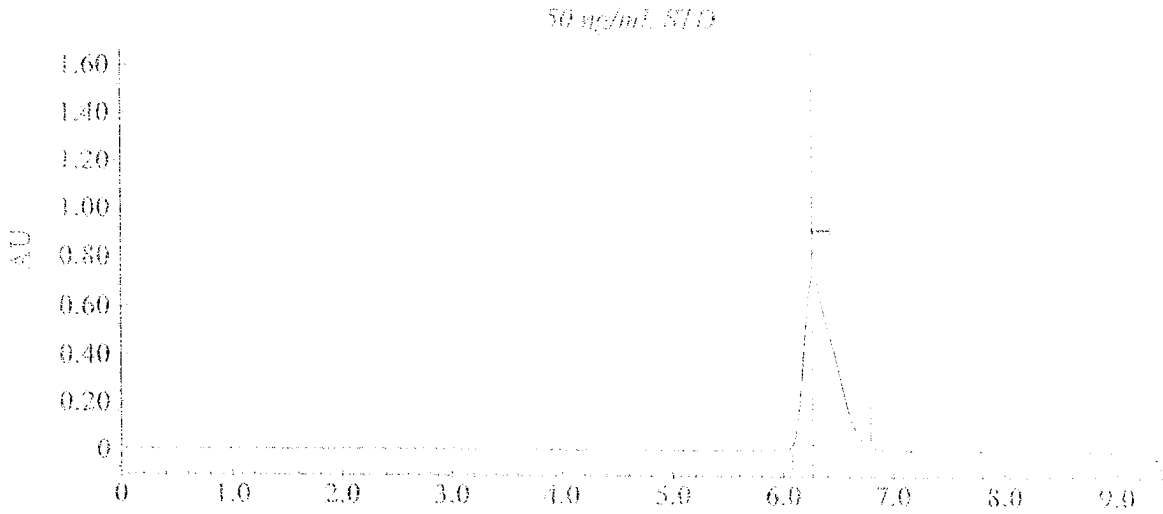

# Sample Analysis Report

Sample Name : TOTAL AIR, Run 1 Imp

Data File Name : C:\PEAKNET\DATA\SIEM2010\030310-05\_005.DXD

Method File Name : c:\peaknet\method\cr6as708.mct

Date Time Collected : 9/20/2010 2:19:44 PM

System Operator :

## Peak Information : All Peaks

Peak #	Component Name	Retention Time	Amount	Peak Area	Peak Height
1	Unknown 1	5.58	0.00	47320	1644
2	Hex Chrome	6.08	1.64	45869	2679

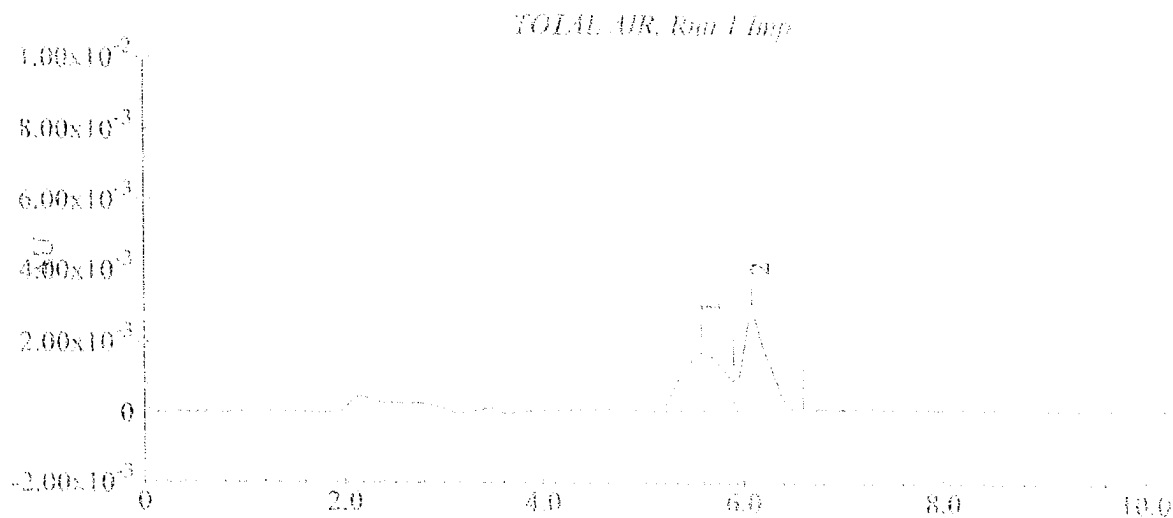



# Sample Analysis Report

Sample Name : TOTAL AIR, Run 1 Rinse

Data File Name : C:\PEAKNET\DATA\SEP2010\76319-01\_006.DXD

Method File Name : c:\peaknet\method\cr6as703.mn1

Date/Time Collected : 9/20/2010 2:31:54 PM

System Operator :

## Peak Information : All Peaks

Peak #	Component Name	Retention Time	Amount	Peak Area	Peak Height
1	Hex Chrome	6.28	1.0	11154	1071

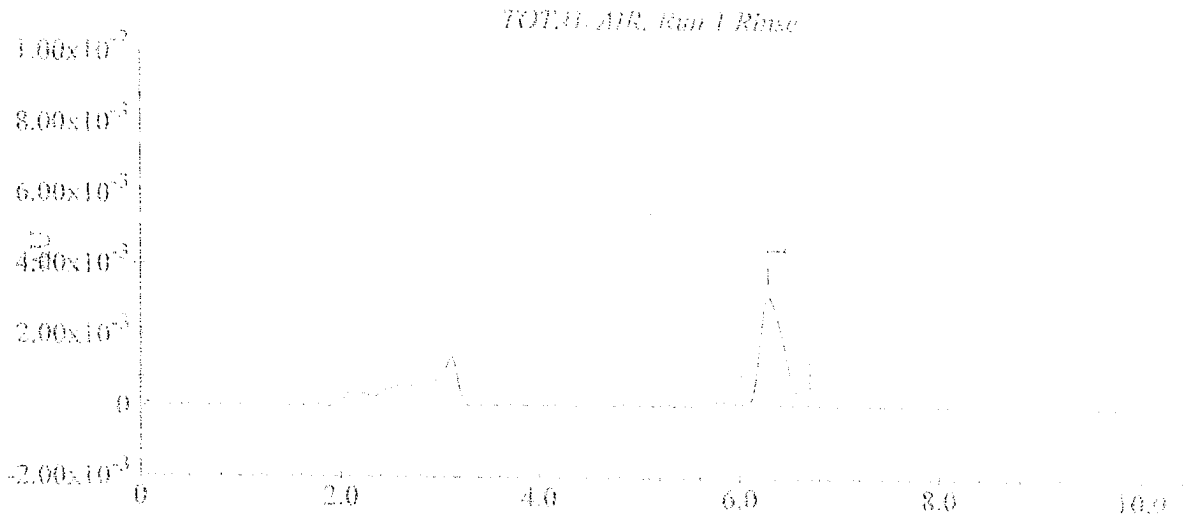

# Sample Analysis Report

Sample Name : TOTAL AIR, Run 2 Imp

Data File Name : CAPKAKNET\DATA\SEP2010\96310-07\_007.DXD

Method File Name : c:\peaksoft\method\cr6as708.mel

Date Time Collected : 9/20/2010 2:44:06 PM

System Operator :

## Peak Information: All Peaks

Peak #	Component Name	Retention Time	Amount	Peak Area	Peak Height
1	Unknown 1	5.58	0.00	39550	1130
2	Hex Chrome	6.18	<i>Jan</i>	64320	1700

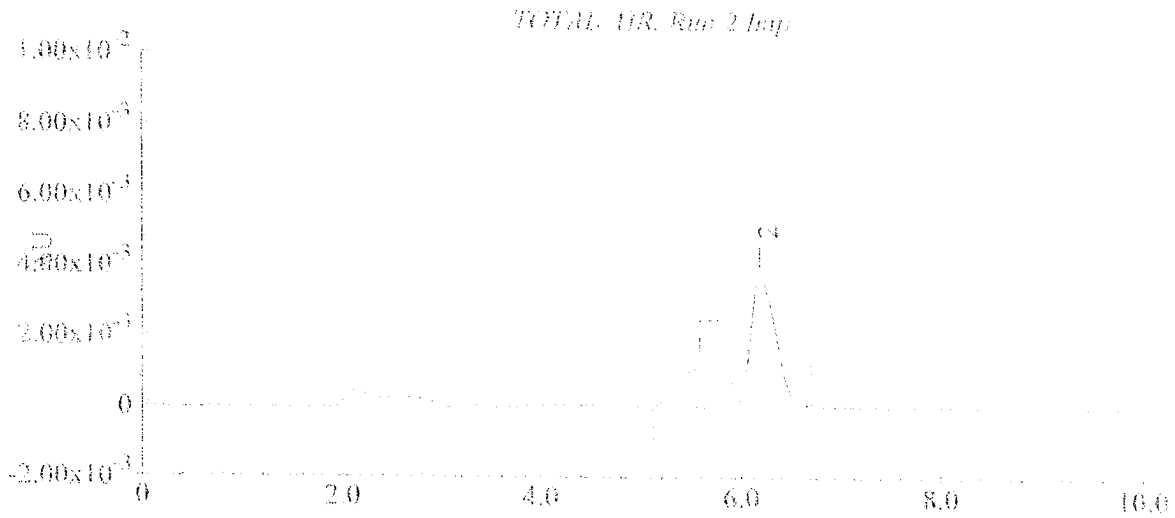

# Sample Analysis Report

Sample Name : TOTAL AIR, Run 2 Rinse

Data File Name : C:\PEAKNET\DATA\ASSET\2010\26310\AIR\_008.D\F1

Method File Name : c:\peaknet\method\ergas708.met

Date Time Collected : 9/20/2010 2:58:18 PM

System Operator :

Peak Information : All Peaks

Peak #	Component Name	Retention Time	Amount	Peak Area	Peak Height
1	Hex Chrome	6.27	1.00	41970	2921

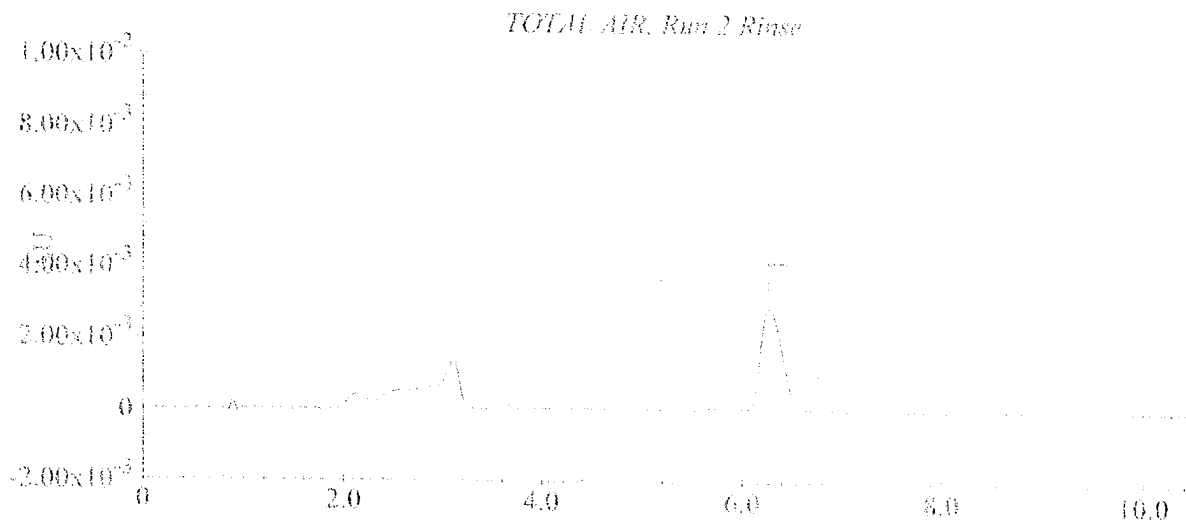

# Sample Analysis Report

Sample Name : TOTAL AIR, Run 3 Imp

Data File Name : C:\PEAKNET\DATA\SEP2010\076310-09\_000.D\01

Method File Name : c:\peaknet\method\cr6as708.mel

Date Time Collected : 9/20/2010 3:09:53 PM

System Operator :

## Peak Information : All Peaks

Peak #	Component Name	Retention Time	Amount	Peak Area	Peak Height
1	Unknown 1	5.58	0.00	42220	1151
2	Hex Chrome	6.22	<i>px</i>	36973	2121

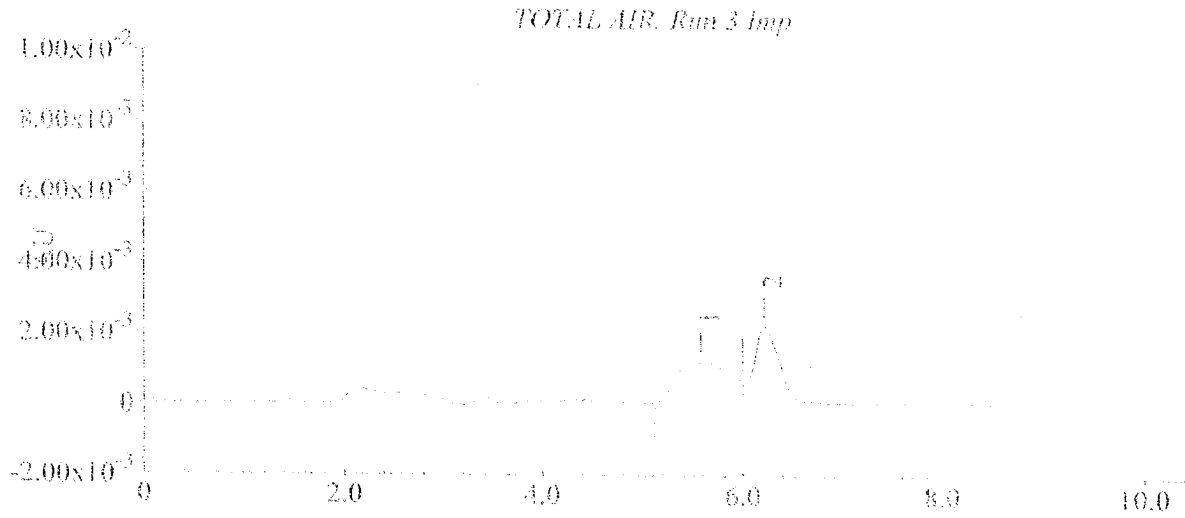

# Sample Analysis Report

Sample Name : TOTAL AIR, Rm 3 Riuse

Data File Name : C:\PEAKNET\DATA\SEP2010\26510-10\_010.DXD

Method File Name : c:\peaknet\method\cr6as708.met

Date Time Collected : 9/20/2010 3:19:20 PM

System Operator :

## Peak Information : All Peaks

Peak #	Component Name	Retention Time	Amount	Peak Area	Peak Height
1	Hex Chrome	6.25	<i>Low</i>	39933	1789

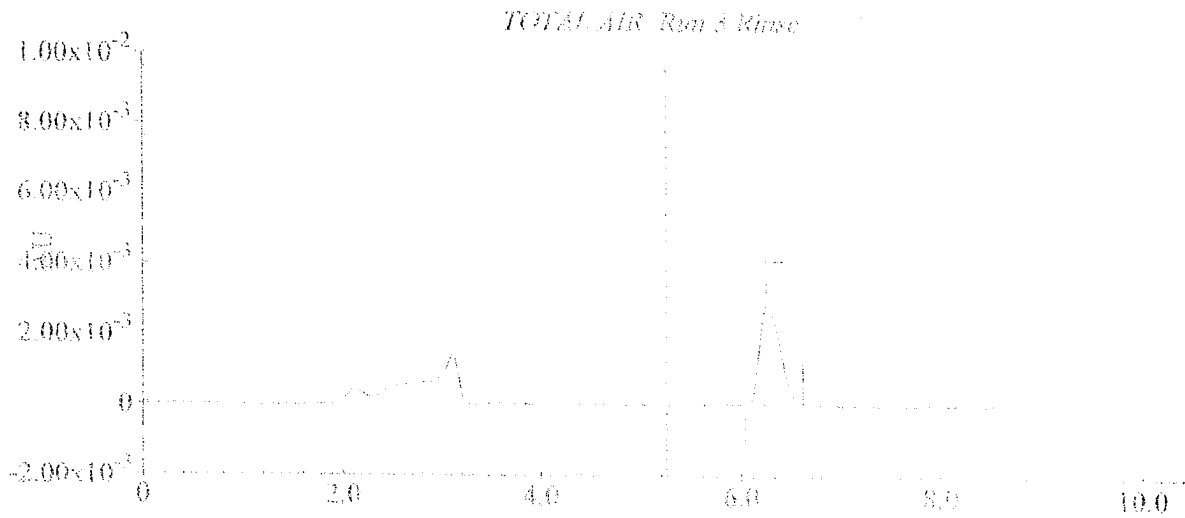

# Sample Analysis Report

Sample Name : TOTAL AIR, Run 3 Rinse DUP

Data File Name : C:\PEAK\NET\DATA\SEP2010\25110-100\_011.DXD

Method File Name : c:\peak\net\method\cr6as708.met

Date Time Collected : 9/20/2010 3:30:14 PM

System Operator :

## Peak Information: All Peaks

Peak #	Component Name	Retention Time	Amount	Peak Area	Peak Height
1	Hex Chrome	6.25	2.21	40025	2819

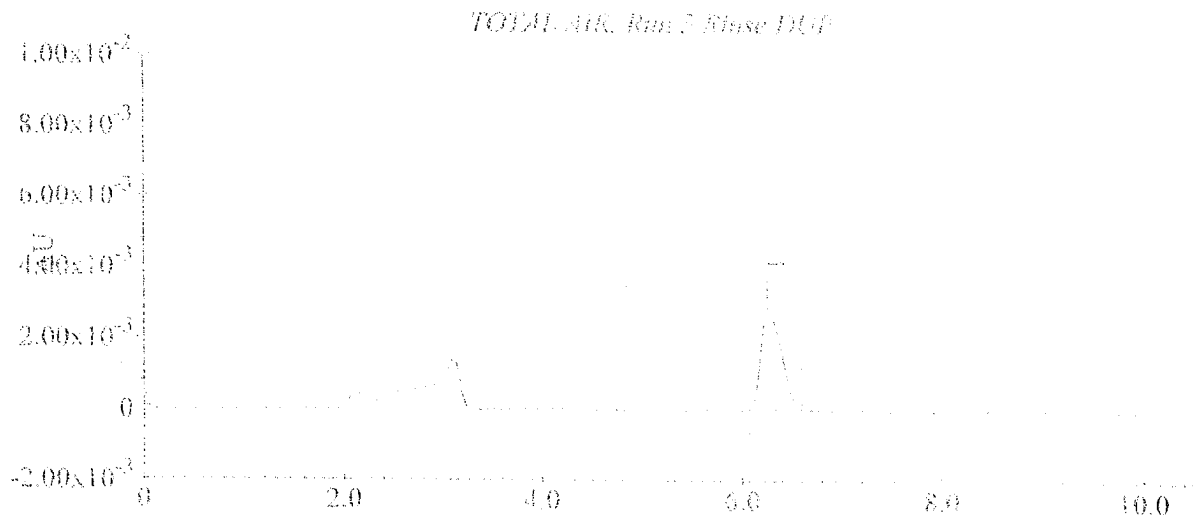

# Sample Analysis Report

Sample Name : TOTAL AIR, Field Blank-Imp

Data File Name : C:\PEAKNET\DATA\SEP2010\26310-11\_611193.D

Method File Name : c:\peaknet\method\Gas708.m

Date Time Collected : 9/20/2010 3:42:35 PM

System Operator :

## Peak Information: All Peaks

Peak #	Component Name	Retention Time	Amount	Peak Area	Peak Height
1	Unknown 1	6.25	0.00	13813	3193

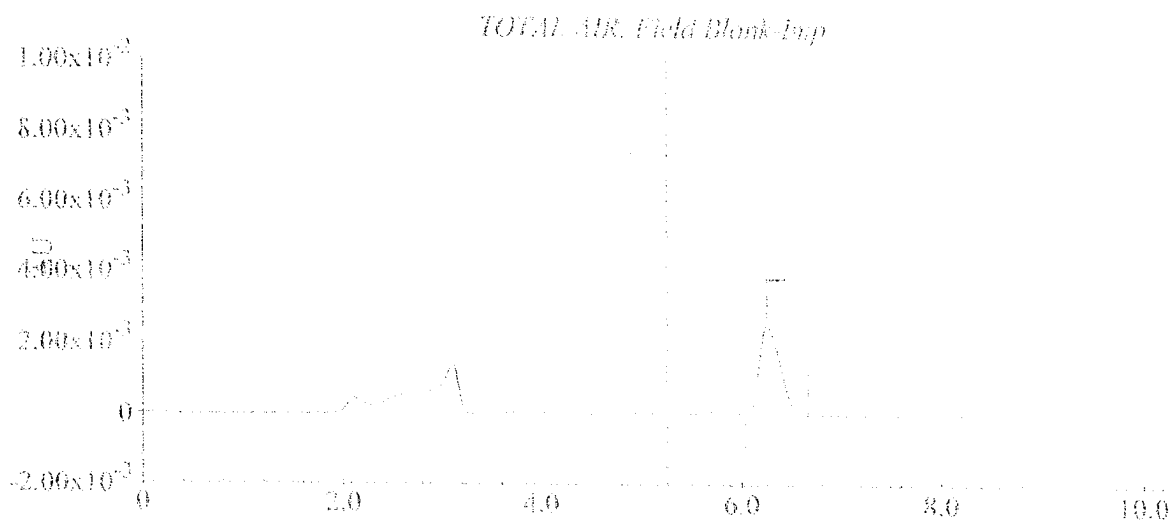

# Sample Analysis Report

Sample Name : TOTAL AIR, Field Blank-Rinse

Data File Name : C:\PEAKNET\DATA\SEP2010\26310\_12\_013.DXD

Method File Name : c:\peaknet\method\cr6as708.nut

Date Time Collected : 9/20/2010 3:52:24 PM

System Operator :

## Peak Information : All Peaks

Peak #	Component Name	Retention Time	Amount	Peak Area	Peak Height
1	Unknown 1	6.25	0.00	405.70	2876

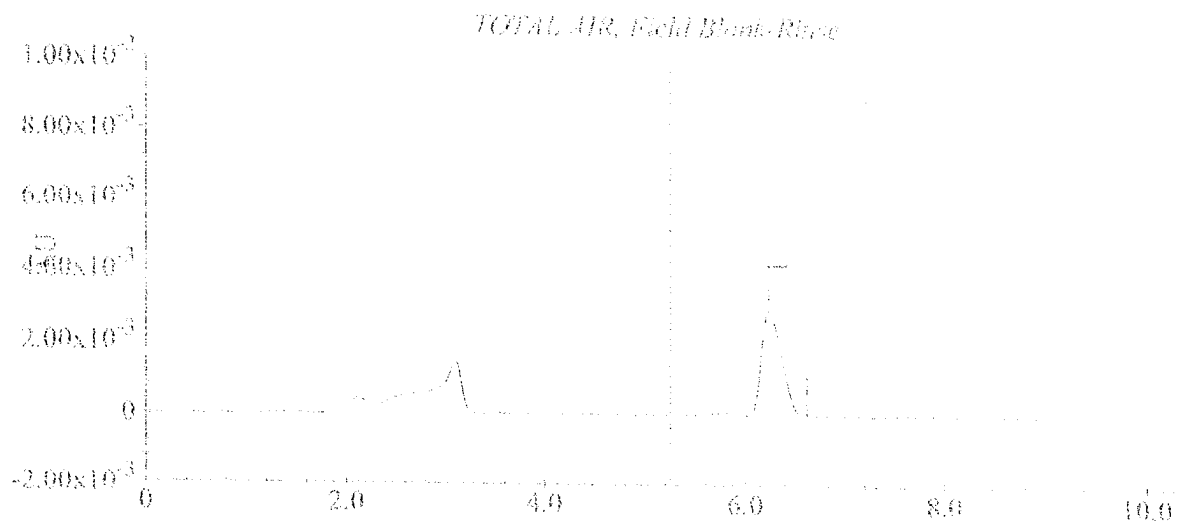



# Sample Analysis Report

Sample Name : TOTAL AIR, Reagent Blank

Data File Name : C:\PEAKNET\DATA\SEP2010\26310-13\_014.DXD

Method File Name : c:\peaknet\method\versar\08.mcd

Date Time Collected : 9/20/2010 4:02:47 PM

System Operator :

## Peak Information : All Peaks

Peak #	Component Name	Retention Time	Amount	Peak Area	Peak Height
1	Unknown 1	6.23	0.00	33100	2171

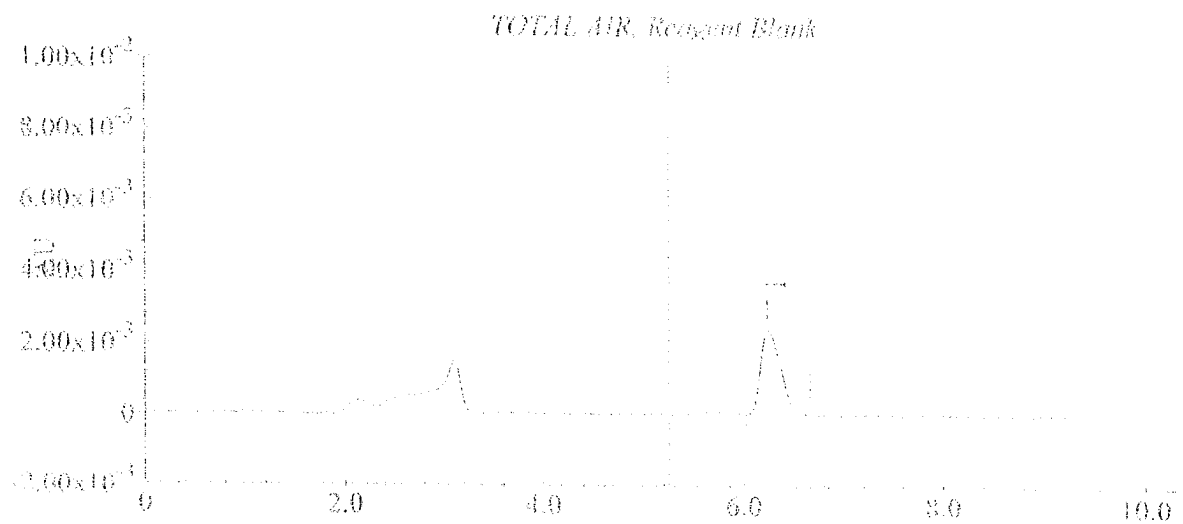

# Sample Analysis Report

Sample Name : 5.0 ug/mL STD

Data File Name : C:\PEAKNET\DATA\SEP2010\26310-14\_015.DXD

Method File Name : c:\peaknet\method\crbas708.mer

Date Time Collected : 9/20/2010 4:14:40 PM

System Operator :

## Peak Information : All Peaks

Peak #	Component Name	Retention Time	Abundant	Peak Area	Peak Height
1	Unknown 1	6.23	6.00	1198982	69105

5.0 ug/mL STD

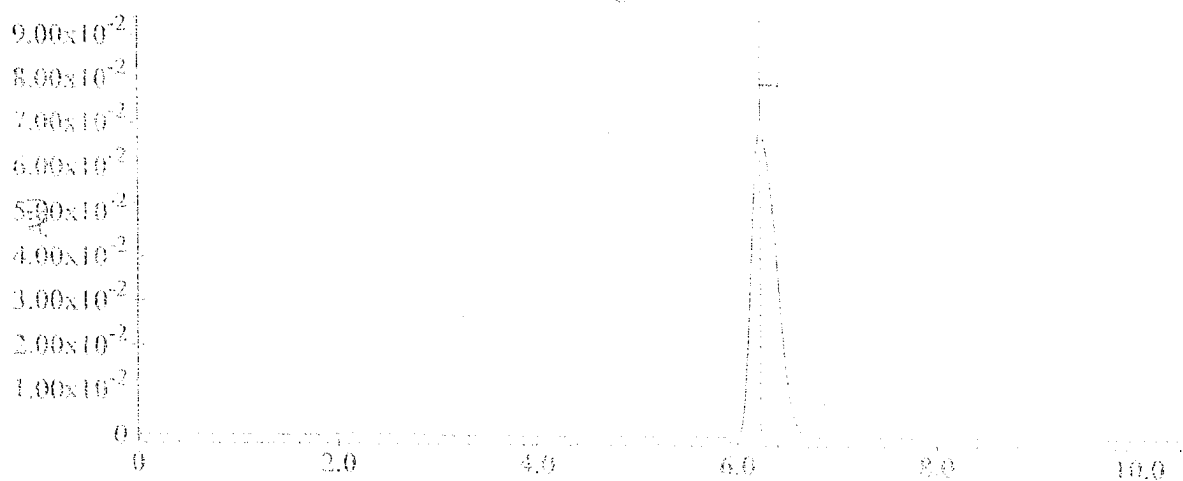

# Sample Analysis Report

Sample Name : BLANK - DI WATER

Data File Name : C:\PEAKNET\DATA\SEP2010\26310-15\_016.D\FID

Method File Name : c:\peaknet\method\cr6as708.met

Date Time Collected : 9/20/2010 4:27:29 PM

System Operator :

## Peak Information : All Peaks

Peak #	Component Name	Retention Time	Amount	Peak Area	Peak Height
--------	----------------	----------------	--------	-----------	-------------

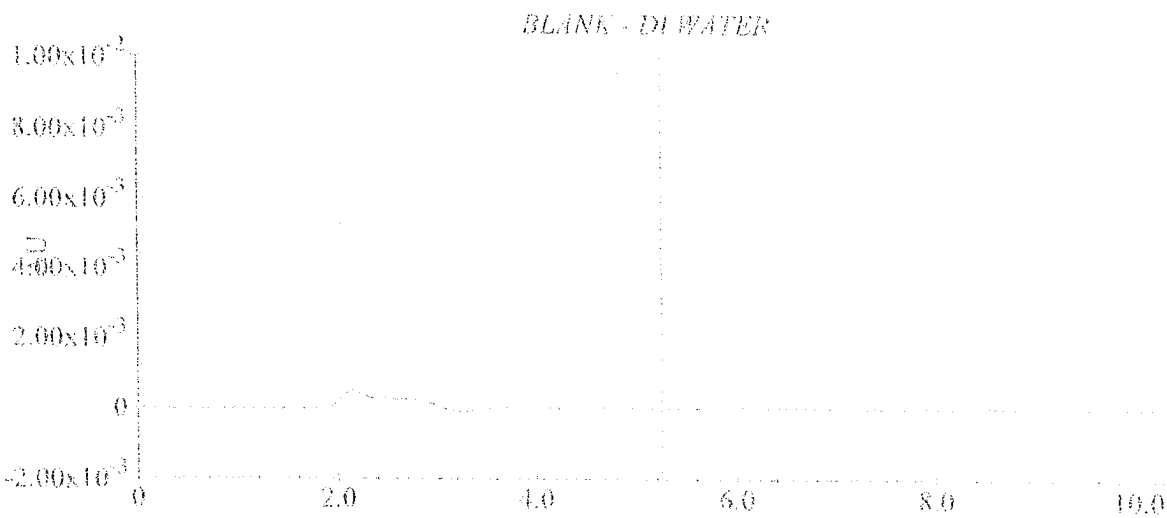

TOTAL AIR ANALYSIS, INC.

Method 5 Field Data Sheet

Pilot Tube Leak Test:

Before: 0.00 After: 0.00

Assumed Moisture: 7.5%

Assumed O<sub>2</sub>: 14.0%

Assumed CO<sub>2</sub>: 5.1%

Ambient Temp.: 7.5%

Facility: SANTA MARIA

Source: FLARE

Test Date: 09/10/2010

Run No.: 1

Project No.: CARB 425-C-16

Method: CARB 425-C-16

Meter No.: AEX 2

dHC: -

Y: 0.9969

Sampling Train Leak Test:

Before: 0.00 e-20

After: 0.00 e-10

Time	Sample Point	Delta P	Delta H	DGM Reading	Temperature		Filter	Pump Vacuities	Imp. Out Temp	Comments
					DGM In	DGM Out				
0 (19:50)	12	0.01	1.5	668.26	1335	63	252	-6		
7.5	11	0.01	1.5	672.15	1342	63	250	-6		
15	10	0.01	1.5	678.50	1329	63	257	-6		
22:00	9	0.01	1.5	682.92	1333	64	249	-6		
30	8	0.01	1.5	687.92	1313	64	258	-6		
37.5	7	0.01	1.5	692.71	1340	63	251	-6		
45	6	0.01	1.5	697.60	1336	63	245	-6		
52.5	5	0.01	1.5	702.49	1334	63	245	-6		
60	4			707.38	1335					
	3									
	2									
	1									
	12	0.01	1.5	707.38	1389	63	240	-6		
7.5	11	0.01	1.5	712.27	1342	63	248	-6		
15.0	10	0.01	1.5	717.16	1383	63	249	-6		
22.5	9	0.01	1.5	721.96	1348	63	250	-6		
30	8	0.01	1.5	726.85	1344	64	254	-6		
37.5	7	0.01	1.5	731.74	1329	65	250	-6		
45	6	0.01	1.5	736.63	1324	66	248	-6		
52.5	5	0.01	1.5	741.52	1346	67	244	-6		
60	4			746.50						
	3									
	2									
	1									

TOTAL AIR ANALYSIS, INC.

Method 5 Field Data Sheet

Facility: SANTA MARIA Stack Dia.: 55' Meter No.: APEX 42 Pitot Tube Leak Test: 0.0  
 Source: FLARE Nozzle Size: 0.75" dH@: 0.0 After: 0.0  
 Test Date: 09/11/2010 Pbar: 29.98 Y: 0.9969 Assumed Moisture: -  
 Run No.: 2 Static P: -0.01 Sampling Train Leak Test: - Assumed O<sub>2</sub>: -  
 Project No.: QUANTZ Before: 0.018 25" Assumed CO<sub>2</sub>: -  
 Method: HPX CHROME Pitot Coef./No.: 0.95 (SD) After: 0.018 22" Ambient Temp.: -

Time	Sample Point	Delta P	Delta H	DGM Reading	Temperature		Stack	DGM In	DGM Out	Probe	Filter	Pump Vacuum	Imp. Out Temp.	Comments
					DGM In	DGM Out								
0	12	0.01	1.5	70.16	74	1321	74				250	-10		
7.5	11	0.01	1.5	75.10	74	1313	74				250	-10		
15	10	0.01	1.5	76.00	74	1322	74				251	-10		
22.5	9	0.01	1.5	76.99	74	1298	74				251	-10		
30	8	0.01	1.5	76.94	74	1301	74				249	-10		
37.5	7	0.01	1.5	77.85	74	1336	74				250	-10		
45	6	0.01	1.5	77.80	74	1349	74				249	-10		
52.5	5	0.01	1.5	78.75	74	1341	74				250	-10		
60	4			78.70										
	3													
	2													
	1													
0	12	0.01	1.5	79.70	74	1359	74				251	-10		
7.5	11	0.01	1.5	79.62	74	1406	74				249	-10		
15	10	0.01	1.5	79.60	74	1406	74				250	-10		
22.5	9	0.01	1.5	80.50	74	1409	74				250	-10		
30	8	0.01	1.5	80.45	74	1379	74				249	-10		
37.5	7	0.01	1.5	81.40	75	1386	75				251	-10		
45	6	0.01	1.5	81.32	75	1396	75				251	-10		
52.5	5	0.01	1.5	82.26	75	1331	75				250	-10		
60	4			82.20										
	3													
	2													
	1													

TOTAL AIR ANALYSIS, INC.

Method 5 Field Data Sheet

Facility: SANTA MARIA Stack Dia.: 55" Meter No.: ALC 2 Pilot Tube Leak Test: Before: 0 After: 6  
 Source: FLARE Nozzle Size: 0.750 dH@: 0.9569 Assumed Moisture: \_\_\_\_\_  
 Test Date: 05/11/2010 Pbar: 29.98 Y: 0.9569 Assumed O<sub>2</sub>: \_\_\_\_\_  
 Run No.: 3 Static P: -0.01 Sampling Train Leak Test: Before: 0.000251 Assumed CO<sub>2</sub>: \_\_\_\_\_  
 Project No.: \_\_\_\_\_ Probe Type: QUMETZ After: 0.002727 Ambient Temp.: \_\_\_\_\_  
 Method: HEX CHARGE Pitot Coef./No.: \_\_\_\_\_

Time	Sample Point	Delta P	Delta H	DGM Reading	Temperature		Filter	Pump Vacuum	Imp. Out Temp	Comments
					Stack	DGM In				
0	12	0.01	1.4	830.70	1380	75	257	-10		
7.5	11	0.01	1.4	831.38	1402	75	250	-10		
15	10	0.01	1.5	840.42	1389	75	251	-10		
22.5	9	0.01	1.5	841.47	1406	75	251	-10		
30	8	0.01	1.5	850.53	1369	75	250	-10		
37.5	7	0.01	1.5	855.50	1346	75	251	-10		
45	6	0.01	1.5	860.40	1348	76	251	-10		
52.5	5	0.01	1.5	865.35	1289	76	250	-10		
60	4			870.30						
	3									
	2									
	1									
0	12	0.01	1.5	870.30	1331	76	250	-10		
7.5	11	0.01	1.5	871.35	1341	76	257	-10		
15	10	0.01	1.5	880.43	1351	76	251	-10		
22.5	9	0.01	1.5	885.46	1342	76	250	-10		
30	8	0.01	1.5	890.33	1340	76	251	-10		
37.5	7	0.01	1.5	895.41	1325	76	251	-10		
45	6	0.01	1.5	900.29	1313	76	249	-10		
52.5	5	0.01	1.5	905.36	1303	76	250	-10		
60	4	0.01	1.5	910.50						
	3									
	2									
	1									

# HEX CHROME

## Total Air Analysis, Inc. Impingers Weight Sheet

Facility: Santa Maria  
 Source: Flare  
 Run No.: 1  
 Test Date: 9/10/10  
 Operator: RPL

Filter No.: YES CARB 425

Impinger No.	Impinger Solution	Amount (ml)	Impinger Type	Weight	Comments
1	0.1 Nopm NaOH	~75	G/S	Final: <del>781.0</del> 781.0	Clear
				Init.: 665.2	
				Net:	
2	0.1 Nopm NaOH	~75	G/S	Final: <del>700.1</del> 700.1	Clear pH ≈ 9.0
				Init.: 670.3	
				Net:	
3	KCl	-	G/S	Final: 605.7	-
				Init.: 601.1	
				Net:	
4	SILICA	~300 g <sub>wt</sub>	KCl G/S	Final: 913.7	-
				Init.: 906.3	
				Net:	
5				Final:	
				Init.:	
				Net:	
6				Final:	
				Init.:	
				Net:	
7				Final:	
				Init.:	
				Net:	

Probe  
Rinse  
= 100 ml

Sample clean

Total Gain: \_\_\_\_\_

Preparation Date: 9/10/10  
 Prepared By: RPL

Recovery Date: 9/10/10  
 Recovered By: RPL

# Total Air Analysis, Inc.

## Impingers Weight Sheet

Facility: Santa Maria  
 Source: Flare  
 Run No.: 2  
 Test Date: 9/11/10  
 Operator: JDG

Filter No.: Yes

CARB 425 - Hex. Chrome

Impinger No.	Impinger Solution	Amount (ml)	Impinger Type	Weight	Comments
1	0.1 N NaOH	~75 uls	G/S	Final: 785.3	Clear
				Init.: 685.1	
				Net:	
2	0.1 N NaOH	~75 uls	G/S	Final: 685.6	Clear pH ≈ 8.5
				Init.: 671.0	
				Net:	
3	K <sub>2</sub> O	-	G/S	Final: 605.2	-
				Init.: 602.7	
				Net:	
4	Silica	~300	mod. G/S	Final: 880.0	-
				Init.: 862.2	
				Net:	
5				Final:	
				Init.:	
				Net:	
6				Final:	
				Init.:	
				Net:	
7				Final:	
				Init.:	
				Net:	

Probe Rinse = 100 uls, clear

Total Gain: \_\_\_\_\_

Preparation Date: 9/11/10

Prepared By: RPL

Recovery Date: 9/11/10

Recovered By: RPL



# Total Air Analysis, Inc.

## Impingers Weight Sheet

Facility: Santa Maria  
 Source: Flare  
 Run No.: 3  
 Test Date: 9/11/10  
 Operator: JDB

Filter No.: Yes

Hex.

Impinger No.	Impinger Solution	Amount (ml)	Impinger Type	Weight	Comments
1	0.1 N NaOH	75 ul	G/S	Final: 793.8	Clear
				Init.: 683.5	
				Net:	
2	0.1 N NaOH	~75ul	G/S	Final: 681.8	Clear PH ~ 9.5
				Init.: 671.2	
				Net:	
3	KO	—	G/S	Final: 607.7	—
				Init.: 605.2	
				Net:	
4	Silica	~300	mod. G/S	Final: 894.7	—
				Init.: 880.0	
				Net:	
5				Final:	
				Init.:	
				Net:	
6				Final:	
				Init.:	
				Net:	
7				Final:	
				Init.:	
				Net:	

100 uls - Clean

Total Gain: \_\_\_\_\_

Preparation Date: 9/11/10

Prepared By: RPL

Recovery Date: 9/11/10

Recovered By: RPL

**Appendix C**

***CARB Method 429 – PAHs Emissions***

**Calculation Spreadsheets, Analytical Results, and Field Data Sheets**

## CARB Method 429 PAH Emissions

Facility:	Santa Maria Landfill	Operator:	JDG
Source:	Flare	Entered By:	RPL
Load:	Normal	Checked By:	RPL
Start Date:	9/9/10		
End Date:	9/10/10		

Data Entry	Symbol	Units	Data	Data	Data
Run Number	-	-	1	2	3
Round Stack, Diameter	ds	inches	55.00	55.00	55.00
Rectangular Stack, Length	L	inches			
Wdth	W	inches			
Nozzle Diameter	dn	inches	0.750	0.750	0.750
Average Stack Temperature	Fs	degrees F	1323.38	1375.00	1375.00
Average Meter Temperature	Fm	degrees F	70.56	64.38	64.00
Barometric Pressure	Pbar	in. Hg	29.94	29.94	29.97
Stack Static Pressure	Pg	in. H2O	-0.01	-0.01	-0.01
Avg. Velocity Head	dP	in. H2O	0.01	0.01	0.01
Avg. Delta H	dH	in. H2O	1.60	1.60	1.60
Pitot Coefficient	Cp	-	0.99	0.99	0.99
Gas Sample Volume	Vm	cubic ft.	78.66	72.67	74.77
Meter Calibration Factor	Y	-	0.9986	0.9986	0.9986
Total Sampling Time	min	minutes	120	120	120
Stack Gas Oxygen Content	Co2,m	%	14.08	14.08	14.12
Stack Gas Carbon Dioxide Content	Cco2,m	%	5.65	5.65	5.61
Total Impinger Gain	Ww	grams	130.4	144.5	117.6

PAH Catch	Mi					
Naphthalene		µg	0.306	0.247		0.665
2-Methylnaphthalene		µg	0.142	0.0933		0.43
Acenaphthene		µg	0.561	0.0266		0.172
Acenaphthylene		µg	0.0125	ND	0.01	0.0265
Fluorene		µg	1.71	0.0511		0.211
Phenanthrene		µg	6.26	0.139		0.444
Anthracene		µg	0.0463	ND	0.01	0.0206
Fluoranthene		µg	0.0349	0.0111		0.0516
Pyrene		µg	0.0513	0.0163		0.144
Benzo (a) anthracene		µg	ND	0.01	ND	0.01
Chrysene		µg	0.0253	ND	0.01	ND
Benzo (b) fluoranthene		µg	ND	0.01	ND	0.01
Benzo (k) fluoranthene		µg	ND	0.01	ND	0.01
Benzo (e) pyrene		µg	ND	0.01	ND	0.01
Benzo (a) pyrene		µg	ND	0.01	ND	0.01
Perylene		µg	ND	0.01	ND	0.01
Indeno (1,2,3-cd) pyrene		µg	ND	0.01	ND	0.01
Dibenz (a,h) anthracene		µg	ND	0.01	ND	0.01
Benzo (g,h,i) perylene		µg	ND	0.01	ND	0.01
<b>Total PAH</b>		µg	9.2	0.7		2.3

## CARB Method 429 PAH Emissions

PAH Molecular Weight	MW				
Naphthalene		lb/lb-mole	128.2	128.2	128.2
2-Methylnaphthalene		lb/lb-mole	142.0	142.0	142.0
Acenaphthene		lb/lb-mole	154.2	154.2	154.2
Acenaphthylene		lb/lb-mole	152.0	152.0	152.0
Fluorene		lb/lb-mole	166.2	166.2	166.2
Phenanthrene		lb/lb-mole	178.2	178.2	178.2
Anthracene		lb/lb-mole	178.2	178.2	178.2
Fluoranthene		lb/lb-mole	202.0	202.0	202.0
Pyrene		lb/lb-mole	202.2	202.2	202.2
Benzo (a) anthracene		lb/lb-mole	228.3	228.3	228.3
Chrysene		lb/lb-mole	228.3	228.3	228.3
Benzo (b) fluoranthene		lb/lb-mole	252.0	252.0	252.0
Benzo (k) fluoranthene		lb/lb-mole	252.0	252.0	252.0
Benzo (e) pyrene		lb/lb-mole	252.3	252.3	252.3
Benzo (a) pyrene		lb/lb-mole	252.3	252.3	252.3
Perylene		lb/lb-mole	252.0	252.0	252.0
Indeno (1,2,3-cd) pyrene		lb/lb-mole	276.0	276.0	276.0
Dibenz (a,h) anthracene		lb/lb-mole	278.3	278.3	278.3
Benzo (g,h,i) perylene		lb/lb-mole	276.0	276.0	276.0

Calculated Data	Symbol	Units	Data	Data	Data
Run Number	-	-	1	2	3
Nozzle Area, $A_n = 3.14(d_n)^2/4$	$A_n$	sq. in.	0.44	0.44	0.44
Stack Area, $A_s = 3.14(d_s)^2/4$ $= L * W/144$ (Rectangular)	$A_s$	sq. feet	16.499	16.499	16.499
Avg. Stack Temperature, $T_s = F_s + 460$	$T_s$	degrees R	1783.38	1835.00	1835.00
Avg. Meter Temperature, $T_m = F_m + 460$	$T_m$	degrees R	530.56	524.38	524.00
Gas Sample Volume @ Standard Conditions, $V_{mStd} = 17.64 Y (V_m/T_m) (P_{bar} + dH/13.6)$	$V_{mStd}$	cubic ft.	78.53	73.41	75.66
Volume of Water Vapor, $V_{wStd} = 0.04707 * W_w$	$V_{wStd}$	cubic ft.	6.14	6.80	5.54
Moist. Fraction, $B_{ws} = V_{wStd}/(V_{mStd} + V_{wStd})$	$B_{ws}$	-	0.072	0.085	0.068
Dry Stack Gas Mol. Weight, $M_d = 0.32(Co_{2,m}) + 0.44(Cco_{2,m}) + 0.28\{100 - (Co_{2,m}) - (Cco_{2,m})\}$	$M_d$	g/g-mole	29.47	29.47	29.46
Wet Stack Gas Molecular Weight, $M_w = M_d(1 - B_{ws}) + 18.0(B_{ws})$	$M_w$	g/g-mole	28.64	28.49	28.68
Absolute Stack Pressure, $P_s = P_{bar} + P_g/13.6$	$P_s$	in. Hg	29.94	29.94	29.97
Stack Gas Velocity $V_s = 85.49 C_p \{ \sqrt{[(dP * T_s) / (P_s * M_w)]} \}$ $V_{sm} = 0.3048 * v_s$	$V_s$ $V_{sm}$	ft/s m/s	12.21 3.72	12.41 3.78	12.37 3.77
Actual Stack Gas Flow Rate, $Q = 60 * v_s * A_s$	$Q$	acf/min	12,084	12,288	12,242
Dry Gas Stack Flowrate (Dry, STD) $Q_{sd} = 17.64 * Q * (1 - B_{ws}) * (P_s / T_s)$	$Q_{sd}$	dscf/min	3,320	3,238	3,288
$Q_{sdm} = Q_{sd} / 35.32$	$Q_{sdm}$	dscm/min	94	92	93
Isokinetic Rate, $I = 13.61 * T_s * V_{mStd} / [P_s * v_s * A_n * \min(1 - B_{ws})]$	$I$	%	106.07	101.67	103.21

## CARB Method 429 PAH Emissions

PAH Concentration $C_i = M_i/V_mStd * 35.31e-3$	$C_i$						
Naphthalene	mg/dscm	0	1.38E-04	0	1.19E-04	0	3.10E-04
2-Methylnaphthalene	mg/dscm	0	6.38E-05	0	4.49E-05	0	2.01E-04
Acenaphthene	mg/dscm	0	2.52E-04	0	1.28E-05	0	8.03E-05
Acenaphthylene	mg/dscm	0	5.62E-06	ND	4.81E-06	0	1.24E-05
Fluorene	mg/dscm	0	7.69E-04	0	2.46E-05	0	9.85E-05
Phenanthrene	mg/dscm	0	2.81E-03	0	6.69E-05	0	2.07E-04
Anthracene	mg/dscm	0	2.08E-05	ND	4.81E-06	0	9.61E-06
Fluoranthene	mg/dscm	0	1.57E-05	0	5.34E-06	0	2.41E-05
Pyrene	mg/dscm	0	2.31E-05	0	7.84E-06	0	6.72E-05
Benzo (a) anthracene	mg/dscm	ND	4.50E-06	ND	4.81E-06	ND	4.67E-06
Chrysene	mg/dscm	0	1.14E-05	ND	4.81E-06	ND	4.67E-06
Benzo (b) fluoranthene	mg/dscm	ND	4.50E-06	ND	4.81E-06	ND	4.67E-06
Benzo (k) fluoranthene	mg/dscm	ND	4.50E-06	ND	4.81E-06	ND	4.67E-06
Benzo (e) pyrene	mg/dscm	ND	4.50E-06	ND	4.81E-06	ND	4.67E-06
Benzo (a) pyrene	mg/dscm	ND	4.50E-06	ND	4.81E-06	ND	4.67E-06
Perylene	mg/dscm	ND	4.50E-06	ND	4.81E-06	ND	4.67E-06
Indeno (1,2,3-cd) pyrene	mg/dscm	ND	4.50E-06	ND	4.81E-06	ND	4.67E-06
Dibenz (a,h) anthracene	mg/dscm	ND	4.50E-06	ND	4.81E-06	ND	4.67E-06
Benzo (g,h,i) perylene	mg/dscm	ND	4.50E-06	ND	4.81E-06	ND	4.67E-06
<b>Total PAH</b>	mg/dscm	0	4.15E-03	0	3.39E-04	0	1.06E-03

PAH Mass Flow Rate $E_i = C_i * Q_{sdm} * 60 / 454000$	$E_i$						
Naphthalene	lb/hr	0	1.71E-06	0	1.44E-06	0	3.82E-06
2-Methylnaphthalene	lb/hr	0	7.93E-07	0	5.44E-07	0	2.47E-06
Acenaphthene	lb/hr	0	3.13E-06	0	1.55E-07	0	9.87E-07
Acenaphthylene	lb/hr	0	6.98E-08	ND	5.83E-08	0	1.52E-07
Fluorene	lb/hr	0	9.55E-06	0	2.98E-07	0	1.21E-06
Phenanthrene	lb/hr	0	3.50E-05	0	8.10E-07	0	2.55E-06
Anthracene	lb/hr	0	2.59E-07	ND	5.83E-08	0	1.18E-07
Fluoranthene	lb/hr	0	1.95E-07	0	6.47E-08	0	2.96E-07
Pyrene	lb/hr	0	2.87E-07	0	9.50E-08	0	8.27E-07
Benzo (a) anthracene	lb/hr	ND	5.59E-08	ND	5.83E-08	ND	5.74E-08
Chrysene	lb/hr	0	1.41E-07	ND	5.83E-08	ND	5.74E-08
Benzo (b) fluoranthene	lb/hr	ND	5.59E-08	ND	5.83E-08	ND	5.74E-08
Benzo (k) fluoranthene	lb/hr	ND	5.59E-08	ND	5.83E-08	ND	5.74E-08
Benzo (e) pyrene	lb/hr	ND	5.59E-08	ND	5.83E-08	ND	5.74E-08
Benzo (a) pyrene	lb/hr	ND	5.59E-08	ND	5.83E-08	ND	5.74E-08
Perylene	lb/hr	ND	5.59E-08	ND	5.83E-08	ND	5.74E-08
Indeno (1,2,3-cd) pyrene	lb/hr	ND	5.59E-08	ND	5.83E-08	ND	5.74E-08
Dibenz (a,h) anthracene	lb/hr	ND	5.59E-08	ND	5.83E-08	ND	5.74E-08
Benzo (g,h,i) perylene	lb/hr	ND	5.59E-08	ND	5.83E-08	ND	5.74E-08
<b>Total PAH</b>	lb/hr	0	5.16E-05	0	4.11E-06	0	1.30E-05

## CARB Method 429 PAH Emissions

PAH Concentration C,ppm = Mi/VmStd *22.4/MW	C,ppm						
Naphthalene	ppm	0	2.54E-05	0	2.19E-05	0	5.73E-05
2-Methylnaphthalene	ppm	0	1.06E-05	0	7.48E-06	0	3.35E-05
Acenaphthene	ppm	0	3.87E-05	0	1.96E-06	0	1.23E-05
Acenaphthylene	ppm	0	8.75E-07	ND	7.49E-07	0	1.93E-06
Fluorene	ppm	0	1.10E-04	0	3.50E-06	0	1.40E-05
Phenanthrene	ppm	0	3.74E-04	0	8.88E-06	0	2.75E-05
Anthracene	ppm	0	2.77E-06	ND	6.39E-07	0	1.28E-06
Fluoranthene	ppm	0	1.84E-06	0	6.26E-07	0	2.82E-06
Pyrene	ppm	0	2.70E-06	0	9.18E-07	0	7.87E-06
Benzo (a) anthracene	ppm	ND	4.66E-07	ND	4.99E-07	ND	4.84E-07
Chrysene	ppm	0	1.18E-06	ND	4.99E-07	ND	4.84E-07
Benzo (b) fluoranthene	ppm	ND	4.22E-07	ND	4.52E-07	ND	4.39E-07
Benzo (k) fluoranthene	ppm	ND	4.22E-07	ND	4.52E-07	ND	4.39E-07
Benzo (e) pyrene	ppm	ND	4.22E-07	ND	4.51E-07	ND	4.38E-07
Benzo (a) pyrene	ppm	ND	4.22E-07	ND	4.51E-07	ND	4.38E-07
Perylene	ppm	ND	4.22E-07	ND	4.52E-07	ND	4.39E-07
Indeno (1,2,3-cd) pyrene	ppm	ND	3.86E-07	ND	4.13E-07	ND	4.00E-07
Dibenz (a,h) anthracene	ppm	ND	3.82E-07	ND	4.09E-07	ND	3.97E-07
Benzo (g,h,i) perylene	ppm	ND	3.86E-07	ND	4.13E-07	ND	4.00E-07

IMPINGER	FINAL WT.	INITIAL W	NET
1	775.2	676.3	98.9
2	698.5	697.7	0.8
3	621.5	619.3	2.2
4	876.5	848	28.5
		TOTAL	130.4
	Run	1	

	dH	dP	sqrt (dP)	Vm	Ts	Tm, i
1	1.60	0.01	0.1	286.00	1335	71
2	1.60	0.01	0.1		1341	70
3	1.60	0.01	0.1		1305	72
4	1.60	0.01	0.1		1322	71
5	1.60	0.01	0.1		1299	70
6	1.60	0.01	0.1		1288	71
7	1.60	0.01	0.1		1265	70
8	1.60	0.01	0.1		1350	70
9	1.60	0.01	0.1		1336	71
10	1.60	0.01	0.1		1315	71
11	1.60	0.01	0.1		1326	70
12	1.60	0.01	0.1		1352	70
13	1.60	0.01	0.1		1317	71
14	1.60	0.01	0.1		1346	70
15	1.60	0.01	0.1		1335	71
16	1.60	0.01	0.1		1342	70
17						
18						
19						
20						
21						
22						
23						
24				364.66		

**AVERAGE**                      1.6                      0.01                      0.1                      78.66                      1323.375                      71  
0.01

PATs

IMPINGER	FINAL WT.	INITIAL WT	NET
1	766.4	649.4	117
2	678	680	-2
3	621.6	621.5	0.1
4	898.5	869.1	29.4
		TOTAL	144.5
Run		2	

	dH	dP	sqrt (dP)	Vm	Ts	Tm, in	Tm, out
1	1.60	0.01	0.1	368.56	1362	67	
2	1.60	0.01	0.1		1369	66	
3	1.60	0.01	0.1		1372	66	
4	1.60	0.01	0.1		1359	66	
5	1.60	0.01	0.1		1364	66	
6	1.60	0.01	0.1		1372	67	
7	1.60	0.01	0.1		1388	64	
8	1.60	0.01	0.1		1345	64	
9	1.60	0.01	0.1		1386	65	
10	1.60	0.01	0.1		1379	63	
11	1.60	0.01	0.1		1392	63	
12	1.60	0.01	0.1		1401	63	
13	1.60	0.01	0.1		1394	63	
14	1.60	0.01	0.1		1382	63	
15	1.60	0.01	0.1		1366	62	
16	1.60	0.01	0.1		1369	62	
17							
18							
19							
20							
21							
22							
23							
24				441.23			

**AVERAGE      1.6            0.01            0.1            72.67            1375            64**  
 0.01



PAHs

IMPINGER	FINAL WT.	INITIAL WT	NET
1	768.8	669.4	99.4
2	675.9	675.5	0.4
3	620.8	621.6	-0.8
4	892.7	874.1	18.6
		TOTAL	117.6
Run		3	

	dH	dP	sqrt (dP)	Vm	Ts	Tm, in	Tm, out
1	1.60	0.01	0.1	445	1358	72	
2	1.60	0.01	0.1		1351	73	
3	1.60	0.01	0.1		1356	73	
4	1.60	0.01	0.1		1365	73	
5	1.60	0.01	0.1		1372	74	
6	1.60	0.01	0.1		1364	73	
7	1.60	0.01	0.1		1359	74	
8	1.60	0.01	0.1		1342	73	
9	1.60	0.01	0.1		1393	73	
10	1.60	0.01	0.1		1399	73	
11	1.60	0.01	0.1		1389	72	
12	1.60	0.01	0.1		1374	72	
13	1.60	0.01	0.1		1383	72	
14	1.60	0.01	0.1		1394	72	
15	1.60	0.01	0.1		1405	72	
16	1.60	0.01	0.1		1396	71	
17							
18							
19							
20							
21							
22							
23							
24				519.77			

**AVERAGE    1.6            0.01            0.1            74.77            1375            73**  
 0.01

October 04, 2010

**Vista Project I.D.: 32806**

Mr. Russ Logan  
Total Air Analysis  
1210 East 223rd Street Suite 314  
Carson, CA 90745

Dear Mr. Logan,

Enclosed are the results for the four MM5 samples received at Vista Analytical Laboratory on September 14 and Septemeber 17, 2010 under your Project Name "Santa Maria Flare". These samples were extracted and analyzed using CARB Method 429 for PAHs. A standard turnaround time was provided for this work. The reagent sample was placed on hold.

The following report consists of a Sample Inventory (Section I), Analytical Results (Section II) and the Appendix, which contains the chain-of-custody, a list of data qualifiers and abbreviations, Vista's current certifications, and copies of the raw data (if requested).

Vista Analytical Laboratory is committed to serving you effectively. If you require additional information, please contact me at 916-673-1520 or by email at [mmaier@vista-analytical.com](mailto:mmaier@vista-analytical.com). Thank you for choosing Vista as part of your analytical support team.

Sincerely,

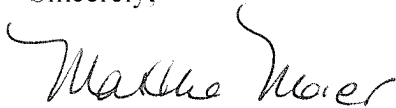

Martha M. Maier  
Laboratory Director



*Vista Analytical Laboratory certifies that the report herein meets all the requirements set forth by NELAP for those applicable test methods. Results relate only to the samples as received by the laboratory. This report should not be reproduced except in full without the written approval of Vista Analytical Laboratory.*



### Section I: Sample Inventory Report

**Date Received:** 9/14/2010  
**Project No.:** 32806  
**Project Name:** Santa Maria Flare

Lab. Sample ID	Client Sample ID	Component ID
001	FLARE RUN 1	BH RINSE
		FH RINSE
		FILTER
		IMP
		XAD
002	FLARE RUN 2	BH RINSE
		FH RINSE
		FILTER
		IMP
		XAD
003	FLARE RUN 3	BH RINSE
		FH RINSE
		FILTER
		IMP
		XAD
004	FIELD BLANK	BH RINSE
		FH RINSE
		FILTER
		IMP
		XAD
005	REAGENT	ACETONE
		HEXANE
		MeCl2
		WATER

## SECTION II

Method Blank		CARB Method 429				
Matrix: MM5	QC Batch No.: 3305	Lab Sample: 0-MB001				
Sample Size: Sample	Date Extracted: 21-Sep-10	Date Analyzed DB-5:				
Analyte	Conc. (ng/Sample)	RL <sup>a</sup>	Qualifiers	Labeled Standard <sup>b</sup>	%R	LCL-UCL <sup>c</sup> Qualifiers
Naphthalene	43.3	25.0		d8-Naphthalene	90.5	50 - 150
2-Methylnaphthalene	ND	10.0		d8-Acenaphthylene	82.5	50 - 150
Acenaphthylene	ND	10.0		d10-Acenaphthene	84.2	50 - 150
Acenaphthene	ND	10.0		d10-Fluorene	82.4	50 - 150
Fluorene	ND	10.0		d10-Phenanthrene	86.1	50 - 150
Phenanthrene	ND	25.0		d10-Fluoranthene	93.3	50 - 150
Anthracene	ND	10.0		d12-Benz(a)anthracene	90.7	50 - 150
Fluoranthene	ND	10.0		d12-Chrysene	88.5	50 - 150
Pyrene	ND	10.0		d12-Benzo(b)fluoranthene	100	50 - 150
Benz(a)anthracene	ND	10.0		d12-Benzo(k)fluoranthene	97.7	50 - 150
Chrysene	ND	10.0		d12-Benzo(a)pyrene	89.1	50 - 150
Benzo(b)fluoranthene	ND	10.0		d12-Indeno(1,2,3-c,d)pyrene	91.4	50 - 150
Benzo(k)fluoranthene	ND	10.0		d14-Dibenz(a,h)anthracene	90.0	50 - 150
Benzo(e)pyrene	ND	10.0		d12-Benzo(g,h,i)perylene	92.8	50 - 150
Benzo(a)pyrene	ND	10.0		d14-Terphenyl	111	50 - 150
Perylene	ND	10.0		d12-Benzo(e)pyrene	112	50 - 150
Indeno(1,2,3-c,d)pyrene	ND	10.0		d10-Anthracene	85.1	50 - 150
Dibenz(a,h)anthracene	ND	10.0				
Benzo(g,h,i)perylene	ND	10.0				

a. Reporting limit.

b. IS, Internal Standards; PS, Pre-Spike Surrogates; AS, Alternate Spike

c. Lower control limit - upper control limit.

Analyst: MAS

Approved By: Martha M. Maier 04-Oct-2010 12:47

LCS Results		CARB Method 429				
Matrix:	MM5	QC Batch No.:	3305	Lab Sample:	0-001LCS1/LCS2	Date Analyzed DB-5:
Sample Size:	Sample	Date Extracted:	21-Sep-10	IS Type	Internal Standard	LCS1-%R LCS2-%R
Analyte	LCS1-%R	LCS2-%R	RPD	IS Type	Internal Standard	LCS1-%R LCS2-%R
Naphthalene	124	127	2.39	IS	d8-Naphthalene	88.3 85.3
2-Methylnaphthalene	119	124	4.12		d8-Acenaphthylene	85.2 85.1
Acenaphthylene	129	130	0.772		d10-Acenaphthene	89.6 86.7
Acenaphthene	112	121	7.73		d10-Fluorene	89.6 92.1
Fluorene	119	118	0.844		d10-Phenanthrene	95.2 97.9
Phenanthrene	113	116	2.62		d10-Fluoranthene	92.9 94.1
Anthracene	106	123	14.8		d12-Benz(a)anthracene	94.7 95.1
Fluoranthene	118	118	0		d12-Chrysene	94.9 95.6
Pyrene	121	117	3.36		d12-Benzo(b)fluoranthene	96.6 97.7
Benz(a)anthracene	122	120	1.65		d12-Benzo(k)fluoranthene	94.3 103
Chrysene	121	118	2.51		d12-Benzo(a)pyrene	87.6 87.6
Benzo(b)fluoranthene	119	124	4.12		d12-Indeno(1,2,3-c,d)pyrene	93.3 97.5
Benzo(k)fluoranthene	124	117	5.81		d14-Dibenz(a,h)anthracene	92.2 96.2
Benzo(e)pyrene	119	113	5.17	PS	d12-Benzo(g,h,i)perylene	91.6 98.3
Benzo(a)pyrene	125	133	6.20		d14-Terphenyl	NA NA
Perylene	121	128	5.62	AS	d12-Benzo(e)pyrene	NA NA
Indeno(1,2,3-c,d)pyrene	123	125	1.61		d10-Anthracene	102 100
Dibenz(a,h)anthracene	125	127	1.59			
Benzo(g,h,i)perylene	121	121	0			

**Sample ID: FLARE RUN 1**
**CARB Method 429**
**Client Data**

Name: Total Air Analysis  
 Project: Santa Maria Flare  
 Date Collected: 9-Sep-10  
 Time Collected: NA

**Sample Data**

Matrix: MM5  
 Sample Size: Sample

**Laboratory Data**

Lab Sample: 32806-001 Date Received: 14-Sep-10  
 QC Batch No.: 3305 Date Extracted: 21-Sep-10  
 Date Analyzed DB-5:

Analyte	Conc. (ng/Sample)	RL <sup>a</sup>	Qualifiers	Labeled Standard <sup>b</sup>	%R	LCL-UCL <sup>c</sup>	Qualifiers
Naphthalene	306	217	B	<u>IS</u> d8-Naphthalene	87.6	50 - 150	
2-Methylnaphthalene	142	10.0		d8-Acenaphthylene	96.8	50 - 150	
Acenaphthylene	12.5	10.0		d10-Acenaphthene	91.3	50 - 150	
Acenaphthene	561	10.0		d10-Fluorene	101	50 - 150	
Fluorene	1710	10.0		d10-Phenanthrene	120	50 - 150	
Phenanthrene	6260	25.0		d10-Fluoranthene	97.7	50 - 150	
Anthracene	46.3	10.0		d12-Benz(a)anthracene	104	50 - 150	
Fluoranthene	34.9	10.0		d12-Chrysene	100	50 - 150	
Pyrene	51.3	10.0		d12-Benzo(b)fluoranthene	107	50 - 150	
Benz(a)anthracene	ND	10.0		d12-Benzo(k)fluoranthene	98.7	50 - 150	
Chrysene	25.3	10.0		d12-Benzo(a)pyrene	96.5	50 - 150	
Benzo(b)fluoranthene	ND	10.0		d12-Indeno(1,2,3-c,d)pyrene	92.1	50 - 150	
Benzo(k)fluoranthene	ND	10.0		d14-Dibenz(a,h)anthracene	95.0	50 - 150	
Benzo(e)pyrene	ND	10.0		d12-Benzo(g,h,i)perylene	86.1	50 - 150	
Benzo(a)pyrene	ND	10.0		d14-Terphenyl	119	50 - 150	
Perylene	ND	10.0		d12-Benzo(e)pyrene	106	50 - 150	
Indeno(1,2,3-c,d)pyrene	ND	10.0		d10-Anthracene	122	50 - 150	
Dibenz(a,h)anthracene	ND	10.0					
Benzo(g,h,i)perylene	ND	10.0					

PS

AS

- a. Reporting limit.
- b. IS, Internal Standards; PS, Pre-Spike Surrogates; AS, Alternate Spike
- c. Lower control limit - upper control limit.

Analyst: MAS

Approved By: Martha M. Maier 04-Oct-2010 12:47

Sample ID: <b>FLARE RUN 2</b>		CARB Method 429					
Client Data		Sample Data		Laboratory Data			
Name:	Total Air Analysis	Matrix:	MM5	Lab Sample:	32806-002		
Project:	Santa Maria Flare	Sample Size:	Sample	QC Batch No.:	3305		
Date Collected:	9-Sep-10			Date Analyzed DB-5:			
Time Collected:	NA			Date Received:	14-Sep-10		
				Date Extracted:	21-Sep-10		
Analyte	Conc. (ng/Sample)	RL <sup>a</sup>	Qualifiers	Labeled Standard <sup>b</sup>	%R	LCL-UCL <sup>c</sup>	Qualifiers
Naphthalene	247	217	B	<u>IS</u> d8-Naphthalene	86.1	50 - 150	
2-Methylnaphthalene	93.3	10.0		d8-Acenaphthylene	87.3	50 - 150	
Acenaphthylene	ND	10.0		d10-Acenaphthene	95.6	50 - 150	
Acenaphthene	26.6	10.0		d10-Fluorene	91.1	50 - 150	
Fluorene	51.1	10.0		d10-Phenanthrene	102	50 - 150	
Phenanthrene	139	25.0		d10-Fluoranthene	95.5	50 - 150	
Anthracene	ND	10.0		d12-Benz(a)anthracene	99.9	50 - 150	
Fluoranthene	11.1	10.0		d12-Chrysene	95.8	50 - 150	
Pyrene	16.3	10.0		d12-Benz(b)fluoranthene	100	50 - 150	
Benz(a)anthracene	ND	10.0		d12-Benz(k)fluoranthene	99.3	50 - 150	
Chrysene	ND	10.0		d12-Benz(a)pyrene	93.7	50 - 150	
Benz(b)fluoranthene	ND	10.0		d12-Indeno(1,2,3-c,d)pyrene	89.9	50 - 150	
Benz(k)fluoranthene	ND	10.0		d14-Dibenz(a,h)anthracene	91.6	50 - 150	
Benz(e)pyrene	ND	10.0		d12-Benz(g,h,i)perylene	85.1	50 - 150	
Benz(a)pyrene	ND	10.0		<u>PS</u> d14-Terphenyl	119	50 - 150	
Perylene	ND	10.0		d12-Benz(e)pyrene	105	50 - 150	
Indeno(1,2,3-c,d)pyrene	ND	10.0		<u>AS</u> d10-Anthracene	113	50 - 150	
Dibenz(a,h)anthracene	ND	10.0					
Benz(g,h,i)perylene	ND	10.0					

a. Reporting limit.  
b. IS, Internal Standards; PS, Pre-Spike Surrogates; AS, Alternate Spike  
c. Lower control limit - upper control limit.

Analyst: MAS  
Approved By: Martha M. Maier 04-Oct-2010 12:47



Sample ID: <b>FLARE RUN 3</b>		CARB Method 429					
Client Data		Sample Data		Laboratory Data			
Name:	Total Air Analysis	Matrix:	MM5	Lab Sample:	32806-003		
Project:	Santa Maria Flare	Sample Size:	Sample	QC Batch No.:	3305		
Date Collected:	10-Sep-10			Date Analyzed DB-5:			
Time Collected:	NA			Date Received:	14-Sep-10		
				Date Extracted:	21-Sep-10		
Analyte	Conc. (ng/Sample)	RL <sup>a</sup>	Qualifiers	Labeled Standard <sup>b</sup>	%R	LCL-UCL <sup>c</sup>	Qualifiers
Naphthalene	665	217	B	<u>IS</u> d8-Naphthalene	83.3	50 - 150	
2-Methylnaphthalene	430	10.0		d8-Acenaphthylene	88.5	50 - 150	
Acenaphthylene	26.5	10.0		d10-Acenaphthene	88.7	50 - 150	
Acenaphthene	172	10.0		d10-Fluorene	97.0	50 - 150	
Fluorene	211	10.0		d10-Phenanthrene	106	50 - 150	
Phenanthrene	444	25.0		d10-Fluoranthene	97.2	50 - 150	
Anthracene	20.6	10.0		d12-Benz(a)anthracene	100	50 - 150	
Fluoranthene	51.6	10.0		d12-Chrysene	97.1	50 - 150	
Pyrene	144	10.0		d12-Benz(b)fluoranthene	102	50 - 150	
Benz(a)anthracene	ND	10.0		d12-Benz(k)fluoranthene	100	50 - 150	
Chrysene	ND	10.0		d12-Benz(a)pyrene	92.0	50 - 150	
Benz(b)fluoranthene	ND	10.0		d12-Indeno(1,2,3-c,d)pyrene	92.2	50 - 150	
Benz(k)fluoranthene	ND	10.0		d14-Dibenz(a,h)anthracene	94.6	50 - 150	
Benz(e)pyrene	ND	10.0		d12-Benz(g,h,i)perylene	83.3	50 - 150	
Benz(a)pyrene	ND	10.0		<u>PS</u> d14-Terphenyl	115	50 - 150	
Perylene	ND	10.0		d12-Benz(o)pyrene	98.2	50 - 150	
Indeno(1,2,3-c,d)pyrene	ND	10.0		<u>AS</u> d10-Anthracene	107	50 - 150	
Dibenz(a,h)anthracene	ND	10.0					
Benz(g,h,i)perylene	ND	10.0					

Analyst: MAS

Approved By: Martha M. Maier 04-Oct-2010 12:47

- a. Reporting limit.
- b. IS, Internal Standards; PS, Pre-Spike Surrogates; AS, Alternate Spike
- c. Lower control limit - upper control limit.

Sample ID: FIELD BLANK		CARB Method 429					
Client Data		Sample Data		Laboratory Data			
Name:	Total Air Analysis	Matrix:	MM5	Lab Sample:	32806-004		
Project:	Santa Maria Flare	Sample Size:	Sample	QC Batch No.:	3305		
Date Collected:	10-Sep-10			Date Analyzed DB-5:			
Time Collected:	NA			Date Received:	17-Sep-10		
				Date Extracted:	21-Sep-10		
Analyte	Conc. (ng/Sample)	RL <sup>a</sup>	Qualifiers	Labeled Standard <sup>b</sup>	%R	LCL-UCL <sup>c</sup>	Qualifiers
Naphthalene	335	217	B	d8-Naphthalene	86.0	50 - 150	
2-Methylnaphthalene	364	10.0		d8-Acenaphthylene	88.0	50 - 150	
Acenaphthylene	16.3	10.0		d10-Acenaphthene	74.9	50 - 150	
Acenaphthene	78.2	10.0		d10-Fluorene	92.5	50 - 150	
Fluorene	137	10.0		d10-Phenanthrene	111	50 - 150	
Phenanthrene	239	25.0		d10-Fluoranthene	99.2	50 - 150	
Anthracene	11.0	10.0		d12-Benz(a)anthracene	99.2	50 - 150	
Fluoranthene	13.2	10.0		d12-Chrysene	98.7	50 - 150	
Pyrene	10.7	10.0		d12-Benzo(b)fluoranthene	111	50 - 150	
Benz(a)anthracene	ND	10.0		d12-Benzo(k)fluoranthene	101	50 - 150	
Chrysene	ND	10.0		d12-Benzo(a)pyrene	97.7	50 - 150	
Benzo(b)fluoranthene	ND	10.0		d12-Indeno(1,2,3-c,d)pyrene	94.9	50 - 150	
Benzo(k)fluoranthene	ND	10.0		d14-Dibenz(a,h)anthracene	97.3	50 - 150	
Benzo(e)pyrene	ND	10.0		d12-Benzo(g,h,i)perylene	86.9	50 - 150	
Benzo(a)pyrene	ND	10.0		d14-Terphenyl	114	50 - 150	
Perylene	ND	10.0		d12-Benzo(e)pyrene	106	50 - 150	
Indeno(1,2,3-c,d)pyrene	ND	10.0		d10-Anthracene	114	50 - 150	
Dibenz(a,h)anthracene	ND	10.0					
Benzo(g,h,i)perylene	ND	10.0					

Analyst: MAS

Approved By: Martha M. Maier 04-Oct-2010 12:47

a. Reporting limit.

b. IS, Internal Standards; PS, Pre-Spike Surrogates; AS, Alternate Spike

c. Lower control limit - upper control limit.

## APPENDIX

## DATA QUALIFIERS & ABBREVIATIONS

<b>B</b>	<b>This compound was also detected in the method blank.</b>
<b>D</b>	<b>Dilution</b>
<b>E</b>	<b>The amount detected is above the High Calibration Limit.</b>
<b>P</b>	<b>The amount reported is the maximum possible concentration due to possible chlorinated diphenylether interference.</b>
<b>H</b>	<b>Recovery was outside laboratory acceptance limits.</b>
<b>I</b>	<b>Chemical Interference</b>
<b>J</b>	<b>The amount detected is below the Low Calibration Limit.</b>
<b>*</b>	<b>See Cover Letter</b>
<b>Conc.</b>	<b>Concentration</b>
<b>DL</b>	<b>Sample-specific estimated detection limit</b>
<b>MDL</b>	<b>The minimum concentration of a substance that can be measured and reported with 99% confidence that the analyte concentration is greater than zero in the matrix tested.</b>
<b>EMPC</b>	<b>Estimated Maximum Possible Concentration</b>
<b>NA</b>	<b>Not applicable</b>
<b>RL</b>	<b>Reporting Limit – concentrations that correspond to low calibration point</b>
<b>ND</b>	<b>Not Detected</b>
<b>TEQ</b>	<b>Toxic Equivalency</b>

Unless otherwise noted, solid sample results are reported in dry weight. Tissue samples are reported in wet weight.

**CERTIFICATIONS**

<b>Accrediting Authority</b>	<b>Certificate Number</b>
State of Alaska, DEC	CA413-2008
State of Arizona	AZ0639
State of Arkansas, DEQ	08-043-0
State of Arkansas, DOH	Reciprocity through CA
State of California – NELAP Primary AA	02102CA
State of Colorado	N/A
State of Connecticut	PH-0182
State of Florida, DEP	E87777
State of Indiana Department of Health	C-CA-02
Commonwealth of Kentucky	90063
State of Louisiana, Health and Hospitals	LA08000
State of Louisiana, DEQ	01977
State of Maine	2008024
State of Michigan	9932
State of Mississippi	Reciprocity through CA
Naval Facilities Engineering Service Center	NFESC413
State of Nevada	CA004132007A
State of New Jersey	CA003
State of New Mexico	Reciprocity through CA
State of New York, DOH	11411
State of North Carolina	06700
State of North Dakota, DOH	R-078
State of Oklahoma	D9919
State of Oregon	CA200001-006
State of Pennsylvania	68-00490
State of South Carolina	87002001
State of Tennessee	TN02996
State of Texas	T104704189-08-TX
U.S. Army Corps of Engineers	N/A
State of Utah	CA16400
Commonwealth of Virginia	00013
State of Washington	C1285
State of Wisconsin	998036160
State of Wyoming	8TMS-Q

Laboratory: Vista

32806, 2.00

# TOTAL AIR ANALYSIS, INC.

1210 East 223 rd Street, # 314 Carson, CA 90745 (310) 518 5133 Fax: (310) 518 5107

Page: 1 of: 2

## CHAIN OF CUSTODY

Client: <u>Santa Maria Flare</u>		Project No.: <u>JA-100887</u>		Analysis		Turnaround Time:			
Contact Person: <u>Russ Logan</u>		Project Name: <u>Flare</u>		<input type="checkbox"/> Same Day <input type="checkbox"/> 24 Hours <input type="checkbox"/> 48 Hours <input checked="" type="checkbox"/> Normal		<input type="checkbox"/> Same Day <input type="checkbox"/> 24 Hours <input type="checkbox"/> 48 Hours <input checked="" type="checkbox"/> Normal			
tel: _____		Project Manager: <u>RPL</u>							
fax: _____		P.O. Number: _____		<div style="transform: rotate(-45deg); border: 1px solid black; padding: 5px; display: inline-block;">           CAPS 429            6/25/10         </div>		Remarks			
Total Air ID #	Client Sample ID	Summa Canister #	Date			Type of Sample	Lab ID Number	<u>Solvent Resins</u> <u>Imp. + Resins</u>	
	<u>Flare Can 1 - Front 1/2</u>	<u>-</u>	<u>9/9/10</u>			<u>Liquis</u>	<u>✓</u>		
	<u>" Can 1 - Back 1/2</u>	<u>-</u>	<u>↓</u>			<u>Solid</u>	<u>✓</u>		
	<u>Flare Can 1 - Filter</u>	<u>-</u>	<u>↓</u>			<u>"</u>	<u>✓</u>		
	<u>" Can 1 - XAD</u>	<u>-</u>	<u>↓</u>			<u>"</u>	<u>✓</u>		
	<u>Flare Can 2 - Front 1/2</u>	<u>-</u>	<u>9/9/10</u>			<u>Liquis</u>	<u>✓</u>		
	<u>" Can 2 - Back 1/2</u>	<u>-</u>	<u>↓</u>			<u>"</u>	<u>✓</u>		
	<u>Flare Can 2 - Filter</u>	<u>-</u>	<u>↓</u>			<u>Solid</u>	<u>✓</u>		
	<u>" Can 2 - XAD</u>	<u>-</u>	<u>↓</u>			<u>"</u>	<u>✓</u>		
	<u>Hexane-Reagent</u>	<u>-</u>	<u>9/10/10</u>	<u>Liquis</u>	<u>✓</u>	<u>50 mls</u>			
	<u>Methylene Chloride</u>	<u>-</u>	<u>"</u>	<u>"</u>	<u>✓</u>	<u>"</u>			
Relinquished by: (signature)		Date/Time		Received by: (signature)		Date/Time			
<u>[Signature]</u>		<u>9/13/10 @ 18:05</u>		<u>Randa Burrell</u>		<u>9/14/10 1515</u>			
Relinquished by: (signature)		Date/Time		Received by: (signature)		Date/Time			
<u>[Signature]</u>									

Laboratory: Nista

# TOTAL AIR ANALYSIS INC.

32804

1210 East 223 rd Street, # 314 Carson, CA 90745 Fax: (310) 518 5133 Fax: (310) 518 5107

Page: 2 of: 2

## CHAIN OF CUSTODY

Client: <u>Santa Maria</u> <u>Flare</u>		Project No.: <u>SA-100887</u>		Analysis		Turnaround Time:	
Contact Person: <u>Russ Logan</u>		Project Name: <u>Flare</u>		<div style="border: 1px solid black; padding: 5px; transform: rotate(-45deg); display: inline-block;">           CARB FLAHS 629         </div>		<input type="checkbox"/> Same Day <input type="checkbox"/> 24 Hours <input type="checkbox"/> 48 Hours <input checked="" type="checkbox"/> Normal	
tel: _____		Project Manager: <u>RLL</u>				Remarks	
fax: _____		P.O. Number: _____					
Total Air ID #	Client Sample ID	Summa Canister #	Date	Type of Sample	Lab ID Number		
	Flare Run 3 - Front 1/2	---	9/10/10	Liquia		✓	
	" " - Back 1/2	---		Solid		✓	
	Flare Run 3 - Filter	---		"		✓	
	" " - XAD	---		"		✓	
*	Field Blank - Front 1/2	---	9/10/10	Liquia		✓	
*	" " - Back 1/2	---		"		✓	
	Field Blank - Filter	---		Solid		✓	
	" " - XAD	---		"		✓	
	Reagent Water	---	9/10/10	Liquia		✓	50mls
	Acetone	---	"	"		✓	"
Relinquished by: (signature)		Date/Time		Received by: (signature)		Date/time	
<u>Russ Logan</u>		9/13/10 @ 18:00		<u>Ronda Bunell</u>		9/14/10 1515	
Relinquished by: (signature)		Date/Time		Received by: (signature)		Date/time	
<u>Russ Logan</u>				<u>*Ronda Bunell</u>		9/17/10 1002	





SAMPLE LOG-IN CHECKLIST



Vista Project #: 32806

TAT Standard

Samples Arrival:	Date/Time <u>9/17/10 0859</u>	Initials: <u>RB</u>	Location: <u>WR-2</u>
			Shelf/Rack: <u>N/A</u>
Logged In:	Date/Time <u>9/17/10 0957</u>	Initials: <u>RB</u>	Location: <u>R-1</u>
			Shelf/Rack: <u>N/A</u>
Delivered By:	<u>FedEx</u>	UPS	Cal
			DHL
			Hand Delivered
			Other
Preservation:	Ice	<u>Blue Ice</u>	Dry Ice
			None
Temp °C	<u>6.9</u>	Time:	<u>0920</u>
			Thermometer ID: IR-1

	YES	NO	NA
Adequate Sample Volume Received?	<input checked="" type="checkbox"/>		
Holding Time Acceptable?	<input checked="" type="checkbox"/>		
Shipping Container(s) Intact?	<input checked="" type="checkbox"/>		
Shipping Custody Seals Intact?			<input checked="" type="checkbox"/>
Shipping Documentation Present?	<input checked="" type="checkbox"/>		
Airbill			
Trk #	<u>7939 2255 7579</u>		
Sample Container Intact?	<input checked="" type="checkbox"/>		
Sample Custody Seals Intact?			<input checked="" type="checkbox"/>
Chain of Custody / Sample Documentation Present?	<input checked="" type="checkbox"/>		
COC Anomaly/Sample Acceptance Form completed?	<input checked="" type="checkbox"/>		
If Chlorinated or Drinking Water Samples, Acceptable Preservation?			<input checked="" type="checkbox"/>
Na <sub>2</sub> S <sub>2</sub> O <sub>3</sub> Preservation Documented?			<u>None</u>
Shipping Container	Vista	<u>Client</u>	Retain
			<u>Return</u>
			Dispose

Comments:

Field Blank  
↓  
Front 1/2 Rinses  
Back 1/2

### Chain of Custody Anomaly/Sample Acceptance Form

Client: Total Air Analysis  
 Contact: Russ Logan  
 Fax Number: 310-5185107

Project Number: 32806  
 Date Received: Sep 14 2010  
 Documented by/date: RY 9/14/10  
                                   XX RB 9/17/10

Please review the following information and complete the Client Authorization section. To comply with NELAC regulations, we must receive authorization before proceeding with sample analysis.

Thank You. ( Fax # 916-673-0106 )

The following information or item is needed to proceed with analysis:

- |  |  |   |
|--|--|---|
| <input type="checkbox"/> Complete Chain-of-Custody | <input type="checkbox"/> Preservative                  | <input type="checkbox"/> Collector's Name |
| <input type="checkbox"/> Test Method Requested     | <input type="checkbox"/> Sample Identification         | <input type="checkbox"/> Sample Type      |
| <input type="checkbox"/> Analyte List Requested    | <input type="checkbox"/> Sample Collection Date / Time | <input type="checkbox"/> Sample Location  |

The following anomalies were noted. Authorization is needed to proceed with the analysis.

Temperature outside  $\pm 2^{\circ}\text{C}$  range    Samples Affected: Field Blank Front 1/2, Back 1/2

~~XX~~ Temperature outside 6.9  $^{\circ}\text{C}$                       Ice present?      Yes                      No

Sample ID Discrepancy                      Samples Affected                      \_\_\_\_\_

Sample holding time missed                      Samples Affected                      \_\_\_\_\_

Custody seals broken                      Samples Affected                      \_\_\_\_\_

Insufficient Sample Size                      Samples Affected                      \_\_\_\_\_

Sample Container(s) Broken                      Samples Affected                      \_\_\_\_\_

Incorrect Container Type                      Samples Affected                      \_\_\_\_\_

\* Other COC and sample label list Back 1/2 Rinse and Impinger as one component for M429.

\* COC lists Field Blank Run components: Front 1/2

Back 1/2  
Filter                      { Post it Note request  
                                   XAD                      using a teflon  
   filter for Field Blank

*The XAD was the only component received*

<b>Client Authorization</b>			
Proceed With Analysis:	YES	NO	Signature and Date _____
Client Comments/Instructions: _____			

Vista Analytical Laboratory  
 El Dorado Hills, CA 95762  
 Phone: (916) 673-1520 Fax: (916) 673-0106

TOTAL AIR ANALYSIS, INC.

Method 5 Field Data Sheet

Facility: Santa Maria Stack Din.: 55' Meter No.: APex #1 Pilot Tube Leak Test: Before: 0.0 After: 0.0  
 Source: Flare Nozzle Size: 0.750 dH@: - Assumed Moisture: 7.5%  
 Test Date: 9/9/10 Pbar: 29.94 Y: 0.9986 Assumed O<sub>2</sub>: 14.0%  
 Run No.: 1 Static P: - 0.1 Sampling Train Leak Test: Before: 0.01 @ 25" After: 0.01 @ 22"  
 Project No.: Quartz Before: 0.01 @ 25" Assumed CO<sub>2</sub>: 5.5%  
 Method: CARD-429 Pitot Coef./No.: 0.99 (Sta) After: 0.01 @ 22" Ambient Temp.: 70°F

Time	Sample Point	Delta P	Delta H	DGM Reading	Temperature		Filter	Pump Vacuum	Imp. Out Temp	Comments
					DGM In	DGM Out				
0	12	0.01	1.6	286.0	71	71	250	-10	55	
7.5	11	0.01	1.6	290.91	70	70	250	-10	55	
15	10	0.01	1.6	295.85	72	72	252	-10	55	
22.5	9	0.01	1.6	300.77	71	71	252	-10	56	
30	8	0.01	1.6	305.64	70	70	252	-10	56	
37.5	7	0.01	1.6	310.55	71	71	248	-10	56	
45	6	0.01	1.6	315.42	70	70	250	-10	57	
52.5	5	0.01	1.6	320.33	70	70	250	-10	57	
60	4	0.01	1.6	325.28	70	70	250	-10	57	
	3									
	2									
	1									
	12	0.01	1.6	325.28	70	70	251	-10	57	
7.5	11	0.01	1.6	330.20	71	71	251	-10	57	
15	10	0.01	1.6	335.11	76	76	250	-10	57	
22.5	9	0.01	1.6	340.00	70	70	248	-10	58	
30	8	0.01	1.6	344.91	70	70	244	-10	58	
37.5	7	0.01	1.6	349.81	71	71	250	-10	58	
45.0	6	0.01	1.6	354.74	70	70	250	-10	58	
52.5	5	0.01	1.6	359.69	70	70	251	-10	58	
60.0	4	0.01	1.6	364.66	70	70	251	-10	58	
	3									
	2									
	1									

TOTAL AIR ANALYSIS, INC.

Method 5 Field Data Sheet

Facility: Santa Maria Stack Dia.: 55" Meter No.: AP60 #1 Pilot Tube Leak Test: 0.0  
 Source: Flare Nozzle Size: 0.750 dH@: - Before: 0.0 After: 0.0  
 Test Date: 9/9/10 Pbar: 29.94 Y: 0.9986 Assumed Moisture: -  
 Run No.: 2 Static P: -0.01 Sampling Train Leak Test: Assumed O<sub>2</sub>  
 Project No.: Quartz Before: 0.01 @ 25' Assumed CO<sub>2</sub>: -  
 Method: PAHs - CARB 429 Pitot Coef./No.: 0.99 (STD) After: 0.005 @ 20' Ambient Temp: -

Time	Sample Point	Delta P	Delta H	DGM Reading	Stack	Temperature		Filter	Pump Vacuum	Imp. Out Temp.	Comments
						DGM In	DGM Out				
0	12	-0.1	1.2	368.56	1362	67		250	-18	57	
7.5	11	-0.1	1.0	373.14	1365	66		250	-18	57	
15	10	-0.1	1.0	377.65	1372	66		251	-18	57	
22.5	9	-0.1	1.0	382.18	1376	66		250	-18	57	
30	8	-0.1	1.0	386.75	1361	66		245	-18	57	
37.5	7	-0.1	1.0	391.26	1372	67		251	-18	57	
45	6	-0.1	1.0	395.80	1388	67		250	-16	57	
52.5	5	-0.1	1.0	400.35	1391	67		252	-16	57	
60	4			404.90							
	3										
	2										
	1										
0	12	-0.1	1.0	404.9	1386	65		251	-16	57	
7.5	11	-0.1	1.0	409.42	1375	65		250	-16	57	
15	10	-0.1	1.0	413.94	1392	63		252	-16	57	
22.5	9	-0.1	1.0	418.55	1401	63		250	-16	57	
30	8	-0.1	1.0	423.10	1394	63		251	-16	57	
37.5	7	-0.1	1.0	427.60	1382	63		251	-16	57	
45	6	-0.1	1.0	432.15	1366	63		250	-16	57	
52.5	5	-0.1	1.0	436.70	1369	62		251	-16	57	
60	4			441.25							
	3										
	2										
	1										

TOTAL AIR ANALYSIS, INC.

Method 5 Field Data Sheet

Facility: Santa Maria Stack Dia.: 55" Meter No.: Apex #1 Pitot Tube Leak Test: Before: 0.0 After: 0.0  
 Source: Flare Nozzle Size: 0.750 dH@: - Assumed Moisture: 0.0  
 Test Date: 9/10/10 Pbar: 29.97 Y: 0.9986 Assumed O<sub>2</sub>: 0.0  
 Run No.: 3 Static P: -0.01 Sampling Train Leak Test: Assumed O<sub>2</sub>: 0.0  
 Project No.: Quartz Before: 0.01 @ 25' Assumed CO<sub>2</sub>: 0.0  
 Method: PATHS - CARB 429 Pilot Coef.No.: 0.99 (Std) After: 0.01 @ 20" Ambient Temp.: 0.0

Time	Sample Point	Delta P	Delta H	DGM Reading	Temperature		Probe	Filter	Pump Vacuum	Imp. Out. Temp.	Comments
					DGM In	DGM Out					
0	12	0.01	1.6	445.0	72			250	-6		
7.5	11	0.01	1.6	449.70	73			250	-6		
11	10	0.01	1.6	454.35	73			251	-6		
22.5	9	0.01	1.6	459.00	73			250	-6		
30	8	0.01	1.6	463.70	74			250	-6		
37.5	7	0.01	1.6	468.35	73			251	-6		
45	6	0.01	1.4	473.00	74			252	-6		
52.5	5	0.01	1.6	477.70	73			251	-6		
60	4	0.01	1.6	482.36	73			250	-6		
	3										
	2										
	1										
0	12	0.01	1.6	482.36	73			250	-6		
7.5	11	0.01	1.6	487.05	73		(1395)	251	-6		
15	10	0.01	1.6	491.70	73		(1385)	251	-6		
22.5	9	0.01	1.4	496.35	72		(1375)	250	-6		
30	8	0.01	1.6	501.05	72		(1383)	248	-6		
37.5	7	0.01	1.6	505.70	72			249	-6		
45	6	0.01	1.6	510.40	72			250	-6		
52.5	5	0.01	1.6	515.10	72			251	-6		
60	4	0.01	1.6	519.77	71				-6		
	3										
	2										
	1										

PAT

# Total Air Analysis, Inc. Impingers Weight Sheet

Facility: Santa Maria  
Source: Flare  
Run No.: 1  
Test Date: 9/9/10  
Operator: SDG

Filter No.: PAT #1

Impinger No.	Impinger Solution	Amount (ml)	Impinger Type	Weight	Comments
1	Sodium Carb/Bi Carb	~75	G/S	Final: 775.2	Clear
				Init.: 676.3	
				Net:	
2	" "	~100	G/S	Final: 698.5	Clear
				Init.: 697.7	
				Net:	
3	KO	-	G/S	Final: <del>621.5</del> 621.5	-
				Init.: 619.3	
				Net:	
4	Silica	~300g	MOD G/S	Final: <del>834</del> 848.0	-
				Init.: 848.0	
				Net:	
5				Final:	
				Init.:	
				Net:	
6				Final:	
				Init.:	
				Net:	
7				Final:	
				Init.:	
				Net:	

Total Gain: \_\_\_\_\_

Preparation Date: 9/9/10  
Prepared By: DPL

Recovery Date: 9/9/10  
Recovered By: DPL

PAMS

Total Air Analysis, Inc.  
Impingers Weight Sheet

Facility: SANTA MARIA  
 Source: FLARE  
 Run No.: 2  
 Test Date: 09/09/2010  
 Operator: JDB

Filter No.: YES - PALL #2

Impinger No.	Impinger Solution	Amount (ml)	Impinger Type	Weight	Comments
1	SODIUM CARB BICARB	~75	G/S	Final: 766.4	Clear
				Init.: 689.4	
				Net:	
2	SODIUM CARB BICARB	~75	G/S	Final: 678.0	Clear
				Init.: 480.0	
				Net:	
3	KO	-	G/S	Final: 621.4	-
				Init.: 621.5	
				Net:	
4	SILICA	~30g	G/S	Final: 818.5	-
				Init.: 826.5 829.1	
				Net:	
5				Final:	
				Init.:	
				Net:	
6				Final:	
				Init.:	
				Net:	
7				Final:	
				Init.:	
				Net:	

Total Gain: \_\_\_\_\_

Preparation Date: 9/9/10

Prepared By: JDB

Recovery Date: 9/9/10

Recovered By: JDB

PAW's

# Total Air Analysis, Inc. Impingers Weight Sheet

Facility: SANTA MARCA  
 Source: FLARE  
 Run No.: 3  
 Test Date: 09/10/2010  
 Operator: JDS

Filter No.: YES FAH #3

Impinger No.	Impinger Solution	Amount (ml)	Impinger Type	Weight	Comments
1	SODIUM CARB BI CARB	~75	GS	Final: 768.8 Init.: 669.7 Net:	Clear
2	SODIUM CARB BI CARB	~75	G/S	Final: 675.9 Init.: 675.5 Net:	Clear
3	KD	-	G/S	Final: 620.8 Init.: 621.6 Net:	-
4	SILICA	~300g	MOD. G/S	Final: 892.7 Init.: 874.1 Net:	-
5				Final: Init.: Net:	
6				Final: Init.: Net:	
7				Final: Init.: Net:	

Total Gain: \_\_\_\_\_

Preparation Date: 9/10/10

Prepared By: RPL

Recovery Date: 9/10/10

Recovered By: RPL



## **Appendix D**

### ***CARB Method 430 – Formaldehyde***

#### **Calculation Spreadsheets, Analytical Results, and Field Data Sheets**

**Facility:** Santa Maria Landfill  
**Source:** Flare  
**Load:** Normal  
**Start Date:** 9/10/2010  
**End Date:** 9/11/2010

**SUMMARY OF RESULTS - FORMALDEHYDE**

Analysis Method		CARB 430		
Field Sample ID #		Front Impinger	Back Impinger	
		PPMV	PPMV	Lb/hr
<b>Formaldehyde</b>				
Flare, Run # 1		0.160	0.009	2.66E-03
Flare, Run # 2		0.200	0.000	3.12E-03
Flare, Run # 3		0.082	0.008	1.40E-03
	<b>Average</b>	<b>0.147</b>	<b>0.006</b>	<b>2.39E-03</b>

**Calculations: Lb/hr = PPMv \* DSCFM \* MW \* Correction factor**

**Example Run #1- Formaldehyde**

**Where:** PPMv = 0.16 Laboratory results  
 DSCFM 3,311 Exhaust Flow rate  
 MW = 30.03 Formaldehyde  
 Correction Factor = 1.583 x 10<sup>-7</sup>

9/28/2010  
Mr. Russ Logan  
Total Air Analysis  
1210 East 223rd St.  
Suite 314  
Carson CA 90745

Project Name: Flare  
Project #: JA-100887  
Workorder #: 1009292

Dear Mr. Russ Logan

The following report includes the data for the above referenced project for sample(s) received on 9/15/2010 at Air Toxics Ltd.

The data and associated QC analyzed by Modified CARB 430 are compliant with the project requirements or laboratory criteria with the exception of the deviations noted in the attached case narrative.

Thank you for choosing Air Toxics Ltd. for your air analysis needs. Air Toxics Ltd. is committed to providing accurate data of the highest quality. Please feel free to contact the Project Manager: Kyle Vagadori at 916-985-1000 if you have any questions regarding the data in this report.

Regards,



Kyle Vagadori  
Project Manager

**WORK ORDER #: 1009292**

Work Order Summary

<b>CLIENT:</b>	Mr. Russ Logan Total Air Analysis 1210 East 223rd St. Suite 314 Carson, CA 90745	<b>BILL TO:</b>	Mr. Russ Logan Total Air Analysis 1210 East 223rd St. Suite 314 Carson, CA 90745
<b>PHONE:</b>	310-518-5133	<b>P.O. #</b>	
<b>FAX:</b>		<b>PROJECT #</b>	JA-100887 Flare
<b>DATE RECEIVED:</b>	09/15/2010	<b>CONTACT:</b>	Kyle Vagadori
<b>DATE COMPLETED:</b>	09/28/2010		

<u>FRACTION #</u>	<u>NAME</u>	<u>TEST</u>
01A	Flare Run 1-A	Modified CARB 430
01B	Flare Run 1-B	Modified CARB 430
01BB	Flare Run 1-B Lab Duplicate	Modified CARB 430
02AB	Flare Run 2-A/Flare Run 2-B	Modified CARB 430
03A	Flare Run 3-A	Modified CARB 430
03B	Flare Run 3-B	Modified CARB 430
03BMS	Flare Run 3-B MS	Modified CARB 430
04A	Field Blank - A	Modified CARB 430
05A	Field Blank - B	Modified CARB 430
06A	Reagent Blank	Modified CARB 430
07A	Trip Spike	Modified CARB 430
08A	Trip Blank	Modified CARB 430
09A	Lab Blank	Modified CARB 430
10A	LCS	Modified CARB 430

CERTIFIED BY:

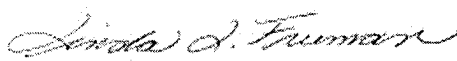

Laboratory Director

DATE: 09/28/10

Certification numbers: CA NELAP - 02110CA, LA NELAP/LELAP- AI 30763,  
NY NELAP - 11291, UT NELAP - 9166389892, AZ Licensure AZ0719

Name of Accrediting Agency: NELAP/Florida Department of Health, Scope of Application: Clean Air Act,  
Accreditation number: E87680, Effective date: 07/01/09, Expiration date: 06/30/11  
Air Toxics Ltd. certifies that the test results contained in this report meet all requirements of the NELAC standards

This report shall not be reproduced, except in full, without the written approval of Air Toxics Ltd.

180 BLUE RAVINE ROAD, SUITE B FOLSOM, CA - 95630  
(916) 985-1000 . (800) 985-5955 . FAX (916) 985-1020

**LABORATORY NARRATIVE  
Modified CARB 430  
Total Air Analysis  
Workorder# 1009292**

Nine DNPH Screw Cap Vial and two VOA Vial-40 mL samples were received on September 15, 2010. The laboratory performed analysis via modified Method CARB 430 using reverse phase High Pressure Liquid Chromatography (HPLC) with an Ultraviolet (UV) Detector. The method involves extracting the derivatized aldehydes and ketones from the impinger solution. See the data sheets for the reporting limits for each compound.

<i>Requirement</i>	<i>CARB 430</i>	<i>ATL Modifications</i>
Extraction	Serially extracted three times.	Single extraction is sufficient and minimizes further addition of background contamination.
Reagent Certification/Field Blank	4 Reagent Blanks will be prepared and flushed through the same length sample line and same type of impinger as will be used in the field. Field Blank criteria: < 10 % of sample values on a total sampling train.	Criteria are < RL for all analytes. 4 Reagent Blanks are prepared by taking four 10 mL aliquots and extracting them using the same procedure as is used to extract samples.
DNPH Certification	New crystals should be analyzed by acidifying with 1mL of 2N Hydrochloric Acid per 100mL DNPH	DNPH reagent is certified at the time of shipment to verify the purity of the crystals.
Sample Quantitation	Use daily RF.	Use ICAL RF.
Retention Time (RT) Precision	%RPD < 2 % for daily calibration standards	RT widths determined by bracketing standards analyzed before and after the sample.
Limit of Detection	The "limit of detection" is defined as the upper bound of the 95% confidence interval for the analysis of at least 4 Reagent Blanks.	Detection Limit is based on the current MDL study which is calculated from a minimum of 7 extracted spikes following 40 CFR Part 136 App. B.
Field Blank Subtraction	Subtract the average of the Field Blanks from the sample result.	Blank subtraction is not performed on sample results.
LCS	If the LCS is out it must be re-extracted until it is in or re-calibrate.	The LCS is only extracted once with out-of-control recoveries flagged.

<i>Requirement</i>	<i>CARB 430</i>	<i>ATL Modifications</i>
Weight Measurements	Measure the weight of each vial before and after sampling to establish no loss of contents.	Weight measurements are not taken.
Calibration Standard Precision	%RSD +/- 10%.	Not measured; recovery of all Continuing Calibration standards must be 90 - 110%.

**Receiving Notes**

The number of samples received did not match the information on the Chain of Custody (COC). Samples Trip Spike and Trip Blank were added to the analytical request.

Sample collection date was not provided on the Chain of Custody (COC) for all samples. The sampling date was taken from the tag.

**Analytical Notes**

The field blanks and equipment blank samples Field Blank-A, Field Blank-B, and Reagent Blank have reportable levels of Formaldehyde. Reanalysis of the extract confirmed the initial results

Sampling volume was supplied by the client. A sample volume of 131 L was assumed for all QC samples.

A front and back impinger was received for each sample. Each impinger was analyzed separately. The results for each analyte were then additively combined and reported as a single concentration for sample Flare Run 2-A/Flare Run 2-B.

**Definition of Data Qualifying Flags**

Seven qualifiers may have been used on the data analysis sheets and indicate as follows:

- B- Compound present in laboratory blank greater than reporting limit.
- J - Estimated value.
- E - Exceeds instrument calibration range.
- S - Saturated peak.
- Q - Exceeds quality control limits.
- U - Compound analyzed for but not detected above the detection limit.
- M - Reported value may be biased due to apparent matrix interferences.

File extensions may have been used on the data analysis sheets and indicates as follows:

- a-File was requantified
- b-File was quantified by a second column and detector
- r1-File was requantified for the purpose of reissue



**Summary of Detected Compounds  
MODIFIED CARB METHOD 430 HPLC**

**Client Sample ID: Flare Run 1-A**

**Lab ID#: 1009292-01A**

<b>Compound</b>	<b>Rpt. Limit (ug)</b>	<b>Rpt. Limit (ppmv)</b>	<b>Amount (ug)</b>	<b>Amount (ppmv)</b>
Formaldehyde	0.50	0.0031	26	0.16

**Client Sample ID: Flare Run 1-B**

**Lab ID#: 1009292-01B**

<b>Compound</b>	<b>Rpt. Limit (ug)</b>	<b>Rpt. Limit (ppmv)</b>	<b>Amount (ug)</b>	<b>Amount (ppmv)</b>
Formaldehyde	1.1	0.0068	1.4	0.0089

**Client Sample ID: Flare Run 1-B Lab Duplicate**

**Lab ID#: 1009292-01BB**

<b>Compound</b>	<b>Rpt. Limit (ug)</b>	<b>Rpt. Limit (ppmv)</b>	<b>Amount (ug)</b>	<b>Amount (ppmv)</b>
Formaldehyde	0.92	0.0057	1.3	0.0083

**Client Sample ID: Flare Run 2-A/Flare Run 2-B**

**Lab ID#: 1009292-02AB**

<b>Compound</b>	<b>Rpt. Limit (ug)</b>	<b>Rpt. Limit (ppmv)</b>	<b>Amount (ug)</b>	<b>Amount (ppmv)</b>
Formaldehyde	0.50	0.0034	30	0.20
Acetaldehyde	0.50	0.0023	0.51	0.0024

**Client Sample ID: Flare Run 3-A**

**Lab ID#: 1009292-03A**

<b>Compound</b>	<b>Rpt. Limit (ug)</b>	<b>Rpt. Limit (ppmv)</b>	<b>Amount (ug)</b>	<b>Amount (ppmv)</b>
Formaldehyde	0.50	0.0033	12	0.082

**Client Sample ID: Flare Run 3-B**

**Lab ID#: 1009292-03B**



**Summary of Detected Compounds  
MODIFIED CARB METHOD 430 HPLC**

**Client Sample ID: Flare Run 3-B**

**Lab ID#: 1009292-03B**

<b>Compound</b>	<b>Rpt. Limit (ug)</b>	<b>Rpt. Limit (ppmv)</b>	<b>Amount (ug)</b>	<b>Amount (ppmv)</b>
Formaldehyde	1.0	0.0066	1.2	0.0076

**Client Sample ID: Field Blank - A**

**Lab ID#: 1009292-04A**

<b>Compound</b>	<b>Rpt. Limit (ug)</b>	<b>Rpt. Limit (ppmv)</b>	<b>Amount (ug)</b>	<b>Amount (ppmv)</b>
Formaldehyde	0.50	0.0031	0.93	0.0058

**Client Sample ID: Field Blank - B**

**Lab ID#: 1009292-05A**

<b>Compound</b>	<b>Rpt. Limit (ug)</b>	<b>Rpt. Limit (ppmv)</b>	<b>Amount (ug)</b>	<b>Amount (ppmv)</b>
Formaldehyde	0.50	0.0031	0.50	0.0031

**Client Sample ID: Reagent Blank**

**Lab ID#: 1009292-06A**

<b>Compound</b>	<b>Rpt. Limit (ug)</b>	<b>Rpt. Limit (ppmv)</b>	<b>Amount (ug)</b>	<b>Amount (ppmv)</b>
Formaldehyde	0.50	0.0031	0.58	0.0036

**Client Sample ID: Trip Blank**

**Lab ID#: 1009292-08A**

No Detections Were Found.





Client Sample ID: Flare Run 1-A

Lab ID#: 1009292-01A

**MODIFIED CARB METHOD 430 HPLC**

File Name:	f0917028	Date of Collection:	9/10/10
Dil. Factor:	1.00	Date of Analysis:	9/17/10 07:07 PM
		Date of Extraction:	9/17/10

Compound	Rpt. Limit (ug)	Rpt. Limit (ppmv)	Amount (ug)	Amount (ppmv)
Formaldehyde	0.50	0.0031	26	0.16
Acetaldehyde	0.50	0.0021	Not Detected	Not Detected

**Air Sample Volume(L): 131**

Total Volume = 16.0 mL

Container Type: DNPH Screw Cap Vial



Client Sample ID: Flare Run 1-B

Lab ID#: 1009292-01B

**MODIFIED CARB METHOD 430 HPLC**

File Name:	f0917023	Date of Collection:	9/10/10
Dil. Factor:	2.20	Date of Analysis:	9/17/10 05:23 PM
		Date of Extraction:	9/17/10

Compound	Rpt. Limit (ug)	Rpt. Limit (ppmv)	Amount (ug)	Amount (ppmv)
Formaldehyde	1.1	0.0068	1.4	0.0089
Acetaldehyde	1.1	0.0047	Not Detected	Not Detected

Air Sample Volume(L): 131

Total Volume = 11.0 mL

Container Type: DNPH Screw Cap Vial



Client Sample ID: Flare Run 1-B Lab Duplicate

Lab ID#: 1009292-01BB

MODIFIED CARB METHOD 430 HPLC

File Name:	f0917024	Date of Collection:	9/10/10
Dil. Factor:	1.83	Date of Analysis:	9/17/10 05:44 PM
		Date of Extraction:	9/17/10

Compound	Rpt. Limit (ug)	Rpt. Limit (ppmv)	Amount (ug)	Amount (ppmv)
Formaldehyde	0.92	0.0057	1.3	0.0083
Acetaldehyde	0.92	0.0039	Not Detected	Not Detected

Air Sample Volume(L): 131

Total Volume = 11.0 mL

Container Type: DNPH Screw Cap Vial



Client Sample ID: Flare Run 2-A/Flare Run 2-B

Lab ID#: 1009292-02AB

**MODIFIED CARB METHOD 430 HPLC**

File Name:	f0917029	Date of Collection:	9/11/10
Dil. Factor:	1.00	Date of Analysis:	9/17/10 07:28 PM
		Date of Extraction:	9/17/10

Compound	Rpt. Limit (ug)	Rpt. Limit (ppmv)	Amount (ug)	Amount (ppmv)
Formaldehyde	0.50	0.0034	30	0.20
Acetaldehyde	0.50	0.0023	0.51	0.0024

Air Sample Volume(L): 121

Total Volume = 27.0 mL

Container Type: DNPH Screw Cap Vial



Client Sample ID: Flare Run 3-A

Lab ID#: 1009292-03A

MODIFIED CARB METHOD 430 HPLC

File Name:	f0917030	Date of Collection:	9/11/10
Dil. Factor:	1.00	Date of Analysis:	9/17/10 07:49 PM
		Date of Extraction:	9/17/10

Compound	Rpt. Limit (ug)	Rpt. Limit (ppmv)	Amount (ug)	Amount (ppmv)
Formaldehyde	0.50	0.0033	12	0.082
Acetaldehyde	0.50	0.0023	Not Detected	Not Detected

Air Sample Volume(L): 122

Total Volume = 15.0 mL

Container Type: DNPH Screw Cap Vial



Client Sample ID: Flare Run 3-B

Lab ID#: 1009292-03B

**MODIFIED CARB METHOD 430 HPLC**

File Name:	f0917026	Date of Collection:	9/11/10
Dil. Factor:	2.00	Date of Analysis:	9/17/10 06:25 PM
		Date of Extraction:	9/17/10

Compound	Rpt. Limit (ug)	Rpt. Limit (ppmv)	Amount (ug)	Amount (ppmv)
Formaldehyde	1.0	0.0066	1.2	0.0076
Acetaldehyde	1.0	0.0045	Not Detected	Not Detected

Air Sample Volume(L): 122

Total Volume = 12.0 mL

Container Type: DNPH Screw Cap Vial



Client Sample ID: Flare Run 3-B MS

Lab ID#: 1009292-03BMS

MODIFIED CARB METHOD 430 HPLC

File Name:	f0917027	Date of Collection:	9/11/10
Dil. Factor:	2.00	Date of Analysis:	9/17/10 06:46 PM
		Date of Extraction:	9/17/10

Compound	%Recovery
Formaldehyde	95
Acetaldehyde	106

Air Sample Volume(L): 122

Total Volume = 12.0 mL

Container Type: DNPH Screw Cap Vial



Client Sample ID: Field Blank - A

Lab ID#: 1009292-04A

MODIFIED CARB METHOD 430 HPLC

File Name:	f0917020	Date of Collection:	9/11/10
Dil. Factor:	1.00	Date of Analysis:	9/17/10 04:20 PM
		Date of Extraction:	9/17/10

Compound	Rpt. Limit (ug)	Rpt. Limit (ppmv)	Amount (ug)	Amount (ppmv)
Formaldehyde	0.50	0.0031	0.93	0.0058
Acetaldehyde	0.50	0.0021	Not Detected	Not Detected

Air Sample Volume(L): 131

Total Volume = 11.0 mL

Container Type: DNPH Screw Cap Vial





Client Sample ID: Field Blank - B

Lab ID#: 1009292-05A

**MODIFIED CARB METHOD 430 HPLC**

File Name:	f0917019	Date of Collection:	9/11/10
Dil. Factor:	1.00	Date of Analysis:	9/17/10 03:59 PM
		Date of Extraction:	9/17/10

Compound	Rpt. Limit (ug)	Rpt. Limit (ppmv)	Amount (ug)	Amount (ppmv)
Formaldehyde	0.50	0.0031	0.50	0.0031
Acetaldehyde	0.50	0.0021	Not Detected	Not Detected

**Air Sample Volume(L): 131**

Total Volume = 11.0 mL

**Container Type: DNPH Screw Cap Vial**



Client Sample ID: Reagent Blank

Lab ID#: 1009292-06A

**MODIFIED CARB METHOD 430 HPLC**

File Name:	f0917018	Date of Collection:	9/11/10
Dil. Factor:	1.00	Date of Analysis:	9/17/10 03:38 PM
		Date of Extraction:	9/17/10

Compound	Rpt. Limit (ug)	Rpt. Limit (ppmv)	Amount (ug)	Amount (ppmv)
Formaldehyde	0.50	0.0031	0.58	0.0036
Acetaldehyde	0.50	0.0021	Not Detected	Not Detected

**Air Sample Volume(L): 131**

Total Volume = 11.0 mL

**Container Type: DNPH Screw Cap Vial**

Client Sample ID: Trip Spike

Lab ID#: 1009292-07A

**MODIFIED CARB METHOD 430 HPLC**

File Name:	f0917016	Date of Collection: 9/7/10
Dil. Factor:	1.00	Date of Analysis: 9/17/10 02:56 PM
		Date of Extraction: 9/17/10

<b>Compound</b>	<b>%Recovery</b>
Formaldehyde	94
Acetaldehyde	106

**Air Sample Volume(L): 131**

Total Volume = 10.0 mL

**Container Type: VOA Vial-40 mL**



Client Sample ID: Trip Blank

Lab ID#: 1009292-08A

**MODIFIED CARB METHOD 430 HPLC**

File Name:	f0917017	Date of Collection:	9/7/10
Dil. Factor:	1.00	Date of Analysis:	9/17/10 03:17 PM
		Date of Extraction:	9/17/10

Compound	Rpt. Limit (ug)	Rpt. Limit (ppmv)	Amount (ug)	Amount (ppmv)
Formaldehyde	0.50	0.0031	Not Detected	Not Detected
Acetaldehyde	0.50	0.0021	Not Detected	Not Detected

Air Sample Volume(L): 131

Total Volume = 10.0 mL

Container Type: VOA Vial-40 mL



Client Sample ID: Lab Blank

Lab ID#: 1009292-09A

**MODIFIED CARB METHOD 430 HPLC**

File Name:	f0917011	Date of Collection:	NA
Dil. Factor:	1.00	Date of Analysis:	9/17/10 01:12 PM
		Date of Extraction:	9/17/10

Compound	Rpt. Limit (ug)	Rpt. Limit (ppmv)	Amount (ug)	Amount (ppmv)
Formaldehyde	0.50	0.0031	Not Detected	Not Detected
Acetaldehyde	0.50	0.0021	Not Detected	Not Detected

**Air Sample Volume(L): 131**

Total Volume = 10.0 mL

**Container Type: NA - Not Applicable**



Client Sample ID: LCS

Lab ID#: 1009292-10A

**MODIFIED CARB METHOD 430 HPLC**

File Name:	f0917012	Date of Collection: NA
Dil. Factor:	1.00	Date of Analysis: 9/17/10 01:33 PM
		Date of Extraction: 9/17/10

Compound	%Recovery
Formaldehyde	89
Acetaldehyde	111

**Air Sample Volume(L): 131**

Total Volume = 10.0 mL

**Container Type: NA - Not Applicable**

## METHOD 430 FORMALDEHYDE SAMPLING RUN DATA RECORD

Run #: 1 Project #: JA-100887  
 Location: SANTA MARIA Source Name: FLARE  
 Date Sampled: 09/10/2010 Operator: JDY

Only one sampling run per data sheet.

	Clock Time	Rotameter Reading	Flow Rate, Q L/min.	Impinger Temp. °F	Stack Temp. °F	Comments
0	0	1.0	4.778			
1	20	1.0	4.793			
2	40	1.0	4.813			
3	60	1.0	4.828			
4	80	1.0	4.848			
5	100	1.0	4.868			
6	120	1.0	4.908			131-2i sampled

**METHOD 430**  
**FORMALDEHYDE SAMPLING RUN DATA RECORD**

Run #: 2 Project #: JA-100887  
 Location: SANTA MARIA Source Name: FLARE  
 Date Sampled: 09/11/2010 Operator: JDS

Only one sampling run per data sheet.

	Clock Time	Rotameter Reading	Flow Rate, Q ml/min.	Impinger Temp. °F	Stack Temp. °F	Comments
0	0	1.0	4.912			
1	20	1.0	4.933			
2	40	1.0	4.953			
3	60	1.0	4.973			
4	80	1.0	4.993			
5	100	1.0	5.013			
6	120	1.0	5.033			121-Li Sampled



**METHOD 430**  
**FORMALDEHYDE SAMPLING RUN DATA RECORD**

Run #: 3 Project #: JA-100887  
 Location: SANTA MARIA Source Name: FLARE  
 Date Sampled: 09/10/2011 Operator: JDG

Only one sampling run per data sheet.

	Clock Time	Rotameter Reading	Flow Rate, Q ml/min.	Impinger Temp. °F	Stack Temp. °F	Comments
0	0	1.0	5.0345			
1	20	1.0	5.054			
2	40	1.0	5.075			
3	60	1.0	5.095			
4	80	1.0	5.115			
5	100	1.0	5.135			
6	120	1.0	5.157			122.5 - Liters

Laboratory: Air Toxics

1009292

# TOTAL AIR ANALYSIS, INC.

1210 East 223 rd Street, # 314 Carson, CA 90745 (310) 518 5133 Fax: (310) 518 5107

## CHAIN OF CUSTODY

Page: 1 of: 1

Client: <u>Santa Maria Flare</u>		Project No.: <u>JA-100887</u>		Analysis		Turnaround Time:	
Contact Person: <u>Ross Lagan</u>		Project Name: <u>Flare</u>		<input type="checkbox"/> Same Day <input type="checkbox"/> 24 Hours <input type="checkbox"/> 48 Hours <input checked="" type="checkbox"/> Normal		Results in ppm + y99	
tel: _____		Project Manager: <u>Ross</u>					
fax: _____		P.O. Number: _____					
Total Air ID #	Client Sample ID	Summa Canister #	Date	Type of Sample	Lab ID Number	Analysis	Remarks
02AB02A	Flare Run 1 - A	01A		Liquid			Sampling Volume (Liters)
02AB02B	"	01B					Run 1 = 131 Liters
02AB02C	Flare Run 2 - A	02A					Run 2 = 121 Liters
02AB02D	"	02B					Run 3 = 122.5 Liters
02AB02E	Flare Run 3 - A	03A					
02AB02F	"	03B					
02AB02G	Field Nahr - A	04A					
02AB02H	"	05A					
02AB02I	Reagent Blank	06A		Liquid			Field Ex
02AB02J	"	06B					CUSTOMER SEAL INTACT? Y/N NONE/TEMP/LOC
02AB02K	"	06C					
02AB02L	"	06D					
02AB02M	"	06E					
02AB02N	"	06F					
02AB02O	"	06G					
02AB02P	"	06H					
02AB02Q	"	06I					
02AB02R	"	06J					
02AB02S	"	06K					
02AB02T	"	06L					
02AB02U	"	06M					
02AB02V	"	06N					
02AB02W	"	06O					
02AB02X	"	06P					
02AB02Y	"	06Q					
02AB02Z	"	06R					
02AB02AA	"	06S					
02AB02AB	"	06T					
02AB02AC	"	06U					
02AB02AD	"	06V					
02AB02AE	"	06W					
02AB02AF	"	06X					
02AB02AG	"	06Y					
02AB02AH	"	06Z					
02AB02AI	"	07A					
02AB02AJ	"	07B					
02AB02AK	"	07C					
02AB02AL	"	07D					
02AB02AM	"	07E					
02AB02AN	"	07F					
02AB02AO	"	07G					
02AB02AP	"	07H					
02AB02AQ	"	07I					
02AB02AR	"	07J					
02AB02AS	"	07K					
02AB02AT	"	07L					
02AB02AU	"	07M					
02AB02AV	"	07N					
02AB02AW	"	07O					
02AB02AX	"	07P					
02AB02AY	"	07Q					
02AB02AZ	"	07R					
02AB02BA	"	07S					
02AB02BB	"	07T					
02AB02BC	"	07U					
02AB02BD	"	07V					
02AB02BE	"	07W					
02AB02BF	"	07X					
02AB02BG	"	07Y					
02AB02BH	"	07Z					
02AB02BI	"	08A					
02AB02BJ	"	08B					
02AB02BK	"	08C					
02AB02BL	"	08D					
02AB02BM	"	08E					
02AB02BN	"	08F					
02AB02BO	"	08G					
02AB02BP	"	08H					
02AB02BQ	"	08I					
02AB02BR	"	08J					
02AB02BS	"	08K					
02AB02BT	"	08L					
02AB02BU	"	08M					
02AB02BV	"	08N					
02AB02BW	"	08O					
02AB02BX	"	08P					
02AB02BY	"	08Q					
02AB02BZ	"	08R					
02AB02CA	"	08S					
02AB02CB	"	08T					
02AB02CC	"	08U					
02AB02CD	"	08V					
02AB02CE	"	08W					
02AB02CF	"	08X					
02AB02CG	"	08Y					
02AB02CH	"	08Z					
02AB02CI	"	09A					
02AB02CJ	"	09B					
02AB02CK	"	09C					
02AB02CL	"	09D					
02AB02CM	"	09E					
02AB02CN	"	09F					
02AB02CO	"	09G					
02AB02CP	"	09H					
02AB02CQ	"	09I					
02AB02CR	"	09J					
02AB02CS	"	09K					
02AB02CT	"	09L					
02AB02CU	"	09M					
02AB02CV	"	09N					
02AB02CW	"	09O					
02AB02CX	"	09P					
02AB02CY	"	09Q					
02AB02CZ	"	09R					
02AB02DA	"	09S					
02AB02DB	"	09T					
02AB02DC	"	09U					
02AB02DD	"	09V					
02AB02DE	"	09W					
02AB02DF	"	09X					
02AB02DG	"	09Y					
02AB02DH	"	09Z					
02AB02DI	"	10A					
02AB02DJ	"	10B					
02AB02DK	"	10C					
02AB02DL	"	10D					
02AB02DM	"	10E					
02AB02DN	"	10F					
02AB02DO	"	10G					
02AB02DP	"	10H					
02AB02DQ	"	10I					
02AB02DR	"	10J					
02AB02DS	"	10K					
02AB02DT	"	10L					
02AB02DU	"	10M					
02AB02DV	"	10N					
02AB02DW	"	10O					
02AB02DX	"	10P					
02AB02DY	"	10Q					
02AB02DZ	"	10R					
02AB02EA	"	10S					
02AB02EB	"	10T					
02AB02EC	"	10U					
02AB02ED	"	10V					
02AB02EE	"	10W					
02AB02EF	"	10X					
02AB02EG	"	10Y					
02AB02EH	"	10Z					
02AB02EI	"	11A					
02AB02EJ	"	11B					
02AB02EK	"	11C					
02AB02EL	"	11D					
02AB02EM	"	11E					
02AB02EN	"	11F					
02AB02EO	"	11G					
02AB02EP	"	11H					
02AB02EQ	"	11I					
02AB02ER	"	11J					
02AB02ES	"	11K					
02AB02ET	"	11L					
02AB02EU	"	11M					
02AB02EV	"	11N					
02AB02EW	"	11O					
02AB02EX	"	11P					
02AB02EY	"	11Q					
02AB02EZ	"	11R					
02AB02FA	"	11S					
02AB02FB	"	11T					
02AB02FC	"	11U					
02AB02FD	"	11V					
02AB02FE	"	11W					
02AB02FF	"	11X					
02AB02FG	"	11Y					
02AB02FH	"	11Z					
02AB02FI	"	12A					
02AB02FJ	"	12B					
02AB02FK	"	12C					
02AB02FL	"	12D					
02AB02FM	"	12E					
02AB02FN	"	12F					
02AB02FO	"	12G					
02AB02FP	"	12H					
02AB02FQ	"	12I					
02AB02FR	"	12J					
02AB02FS	"	12K					
02AB02FT	"	12L					
02AB02FU	"	12M					
02AB02FV	"	12N					
02AB02FW	"	12O					
02AB02FX	"	12P					
02AB02FY	"	12Q					
02AB02FZ	"	12R					
02AB02GA	"	12S					
02AB02GB	"	12T					
02AB02GC	"	12U					
02AB02GD	"	12V					
02AB02GE	"	12W					
02AB02GF	"	12X					
02AB02GG	"	12Y					
02AB02GH	"	12Z					
02AB02GI	"	13A					
02AB02GJ	"	13B					
02AB02GK	"	13C					
02AB02GL	"	13D					
02AB02GM	"	13E					
02AB02GN	"	13F					

## **Appendix E**

### ***CARB Method 436 – Multiple Metals***

#### **Calculation Spreadsheets, Analytical Results, and Field Data Sheets**

## CARB Method 436 - Multiple Metals

**Facility:** Santa Maria Landfill  
**Source:** Flare  
**Load:** Normal  
**Start Date:** 9/9/2010

**Operator:** JDG  
**Entered By:** Russ L.  
**Checked By:** Andrew K.

Data Entry	Symbol	Units	Data	Data	Data
Run Number	-	-	1	2	3
Date	-	-	9/9/2010	9/9/2010	9/10/2010
Round Stack, Diameter	ds	inches	55.00	55.00	55.00
Rectangular Stack, Length	L	inches			
Width	W	inches			
Nozzle Diameter	dn	inches	0.75	0.75	0.75
Average Stack Temperature	Fs	degrees F	1335.00	1351.00	1357.00
Average Meter Temperature	Fm	degrees F	70.50	64.13	68.56
Barometric Pressure	Pbar	in. Hg	29.94	29.94	29.97
Stack Static Pressure	Pg	in. H2O	-0.01	-0.01	-0.01
Avg. Delta H	dH	in. H2O	1.40	1.50	1.50
Avg. Velocity Head	dP	in. H2O	0.010	0.010	0.010
Pitot Coefficient	Cp	-	0.99	0.99	0.99
Gas Sample Volume	Vm	cubic ft.	70.65	76.03	78.82
Meter Calibration Factor	Y	-	0.9969	0.9969	0.9969
Total Sampling Time	min	minutes	120	120	120
Stack Gas Oxygen Content	Co2,m	%	14.08	14.08	14.12
Stack Gas Carbon Dioxide Content	Cco2,m	%	5.65	5.65	5.61
Total Impinger Gain	Ww	grams	129.9	123.6	112.8

Total Metals Catch						
Arsenic	As	mg/l	0.441	0.375		0.427
Cadmium	Cd	mg/l	ND 0.01	ND 0.01	ND	0.01
Chromium(Total)	Cr	mg/l	0.0407	0.0244		0.0321
Nickel	Ni	mg/l	ND 0.01	ND 0.01	ND	0.01
Manganese	Mn	mg/l	ND 0.01	0.0421	ND	0.01

Total Metals Catch	Vol	mls/sample				
Arsenic	As	ug/sample	150.822	129.75		148.596
Cadmium	Cd	ug/sample	ND 3.42	ND 3.46	ND	3.48
Chromium(Total)	Cr	ug/sample	13.9194	8.4424		11.1708
Nickel	Ni	ug/sample	ND 3.42	ND 3.46	ND	3.48
Manganese	Mn	ug/sample	ND 3.42	14.5666	ND	3.48

Calculated Data	Symbol	Units	Data	Data	Data
Run Number	-	-	1	2	3
Nozzle Area, $A_n = 3.14(d_n)^2/4$	$A_n$	sq. in.	0.44	0.44	0.44
Stack Area, $A_s = 3.14(ds)^2/576$ (Round) = $L * W/144$ (Rectangular)	$A_s$	sq. feet	16.50 0.00	16.50 0.00	16.50 0.00
Avg. Stack Temperature, $T_s = F_s + 460$	$T_s$	degrees R	1795.00	1811.00	1817.00
Avg. Meter Temperature, $T_m = F_m + 460$	$T_m$	degrees R	530.50	524.13	528.56
Gas Sample Volume @ Standard Conditions, $V_{mStd} = 17.64 Y (V_m/T_m) (P_{bar} + dH/13.6)$	$V_{mStd}$	cubic ft.	70.36	76.66	78.88
Volume of Water Vapor, $V_{wStd} = 0.04707 * W_w$	$V_{wStd}$	cubic ft.	6.11	5.82	5.31
Moist. Fraction, $B_{ws} = V_{wStd}/(V_{mStd} + V_{wStd})$	$B_{ws}$	-	0.080	0.071	0.063
Dry Stack Gas Mol. Weight, $M_d = 0.32(Co_{2,m}) + 0.44(Cco_{2,m}) + 0.28\{100 - (Co_{2,m}) - (Cco_{2,m})\}$	$M_d$	g/g-mole	29.47	29.47	29.46
Wet Stack Gas Molecular Weight, $M_w = M_d(1 - B_{ws}) + 18.0(B_{ws})$	$M_w$	g/g-mole	28.55	28.66	28.74
Absolute Stack Pressure, $P_s = P_{bar} + P_g/13.6$	$P_s$	in. Hg	29.94	29.94	29.97
Stack Gas Velocity $v_s = 85.49 C_p \{ \sqrt{[(dP * T_s) / (P_s * M_w)]} \}$ $v_m = 0.3048 * v_s$	$v_s$ $v_{sm}$	ft/s m/s	12.26 3.74	12.30 3.75	12.29 3.75
Actual Stack Gas Flow Rate, $Q = 60 * v_s * A_s$	$Q$	acf/min	12,141	12,172	12,169
Dry Gas Stack Flowrate (Dry,STD) $Q_{sd} = 17.64 * Q * (1 - B_{ws}) * (P_s / T_s)$	$Q_{sd}$	dscf/min	3286.6	3299.3	3317.3
$Q_{sdm} = Q_{sd} / 35.32$	$Q_{sdm}$	dscm/min	93.05	93.41	93.92
Isokinetic Rate, $I = 13.61 * T_s * V_{mStd} / [P_s * v_s * A_n * \min(1 - B_{ws})]$	$I$	%	95.97	104.16	106.60

Metals Concentration					
Arsenic	As	gr/dscf	3.308E-05	2.6117E-05	2.9067E-05
Cadmium	Cd	gr/dscf	7.5E-07	6.9645E-07	6.8073E-07
Chromium(Total)	Cr	gr/dscf	3.053E-06	1.6993E-06	2.1851E-06
Nickel	Ni	gr/dscf	7.5E-07	6.9645E-07	6.8073E-07
Manganese	Mn	gr/dscf	7.5E-07	2.9321E-06	6.8073E-07

Metals Mass Flowrate					
Arsenic	As	lb/hr	9.32E-04	7.39E-04	8.26E-04
Cadmium	Cd	lb/hr	2.113E-05	1.9695E-05	1.9356E-05
Chromium(Total)	Cr	lb/hr	8.599E-05	4.8057E-05	6.2131E-05
Nickel	Ni	lb/hr	2.113E-05	1.9695E-05	1.9356E-05
Manganese	Zn	lb/hr	2.113E-05	8.2918E-05	1.9356E-05

CARB 436 #1

IMPINGER	FINAL WT.	INITIAL W	NET
1	759.3	694	65.3
2	726.7	700.8	25.9
3	600.3	591.3	9
4	884.3	854.6	29.7
		TOTAL	129.9
	Run	1	

	dH	dP	sqrt (dP)	Vm	Ts	Tm, i	Tm, out
1	1.40	0.01	0.1	424.00	1318	71	
2	1.40	0.01	0.1		1331	70	
3	1.40	0.01	0.1		1335	71	
4	1.40	0.01	0.1		1339	71	
5	1.40	0.01	0.1		1327	70	
6	1.40	0.01	0.1		1315	71	
7	1.40	0.01	0.1		1322	71	
8	1.40	0.01	0.1		1336	70	
9	1.40	0.01	0.1		1342	71	
10	1.40	0.01	0.1		1349	70	
11	1.40	0.01	0.1		1346	70	
12	1.40	0.01	0.1		1333	71	
13	1.40	0.01	0.1		1346	71	
14	1.40	0.01	0.1		1340	70	
15	1.40	0.01	0.1		1339	70	
16	1.40	0.01	0.1		1342	70	
17							
18							
19							
20							
21							
22							
23							
24				494.65			
<b>AVERAGE</b>	<b>1.4</b>	<b>0.01</b>	<b>0.1</b> <b>0.01</b>	<b>70.65</b>	<b>1335</b>	<b>71</b>	



CARB 436

IMPINGER	FINAL WT.	INITIAL WT	NET
1	757.8	685.9	71.9
2	707	680.4	26.6
3	601.1	594.3	6.8
4	906.3	898.8	7.5
		TOTAL	112.8
Run	3		

	dH	dP	sqrt (dP)	Vm	Ts	Tm, in	Tm, out
1	1.50	0.01	0.1	586.5	1349	67	
2	1.50	0.01	0.1		1342	67	
3	1.50	0.01	0.1		1356	68	
4	1.50	0.01	0.1		1351	68	
5	1.50	0.01	0.1		1349	69	
6	1.50	0.01	0.1		1345	69	
7	1.50	0.01	0.1		1357	69	
8	1.50	0.01	0.1		1341	70	
9	1.50	0.01	0.1		1363	68	
10	1.50	0.01	0.1		1373	68	
11	1.50	0.01	0.1		1355	68	
12	1.50	0.01	0.1		1368	68	
13	1.50	0.01	0.1		1361	69	
14	1.50	0.01	0.1		1360	69	
15	1.50	0.01	0.1		1369	70	
16	1.50	0.01	0.1		1373	70	
17							
18							
19							
20							
21							
22							
23							
24				665.32			

**AVERAGE**    1.5            0.01            0.1            78.82            1357            69

0.01



# CAL TECH Environmental Laboratories



6814 Rosecrans Avenue. Paramount, CA 90723-3146  
 Telephone: (562) 272-2700 Fax: (562) 272-2789

## ANALYTICAL RESULTS\*

**CTEL Project No:** CT172-1009161  
**Client Name:** Total Air Analysis, Inc.  
 1210 E. 223<sup>rd</sup> Street, #314  
 Carson, CA 90745  
**Attention:** Mr. Ross Logan

**Phone:** (310) 830-2226  
**Fax:** (310) 830-2227

**Project ID:** JA-100887  
**Project Name:** Santa Maria

**Date Sampled:** 09/09/10 – 09/10/10 @ 09:00 am  
**Date Received:** 09/17/10 @ 09:30 am  
**Date Analyzed:** 09/21/10

**Matrix:** Water

Laboratory ID: Client Sample ID:	1009-161-1 Run #1	1009-161-2 Run #2	1009-161-3 Run #3	Method	Units	Detection Limit
Arsenic (As)	0.441	0.375	0.427	SW846 6010B	mg/L	0.01
Cadmium (Cd)	ND	ND	ND	SW846 6010B	mg/L	0.01
Chromium (Cr)	0.0407	0.0244	0.0321	SW846 6010B	mg/L	0.01
Nickel (Ni)	ND	ND	ND	SW846 6010B	mg/L	0.01
Manganese (Mn)	ND	0.0421	ND	SW846 6010B	mg/L	0.01
Acid, Extraction	09/20/10	09/20/10	09/20/10	SW846 3050	Date	

ND = Not Detected at the indicated Detection Limit

**CTEL Project No:** CT172-1009161  
**Client Name:** Total Air Analysis, Inc.  
 1210 E. 223<sup>rd</sup> Street, #314  
 Carson, CA 90745

**Phone:**(310) 830-2226  
**Fax:** (310) 830-2227

**Attention:** Mr. Ross Logan

**Project ID:** JA-100887  
**Project Name:** Santa Maria

**Date Sampled:** 09/09/10 – 09/10/10 @ 09:00 am  
**Date Received:** 09/17/10 @ 09:30 am  
**Date Analyzed:** 09/21/10

**Matrix:** Water

<b>Laboratory ID:</b>	1009-161-4	1009-161-5	1009-161-6	<b>Method</b>	<b>Units</b>	<b>Detection Limit</b>
<b>Client Sample ID:</b>	Field Blank	Reagent Blank	Reagent Blank			
Arsenic (As)	ND	ND	ND	SW846 6010B	mg/L	0.01
Cadmium (Cd)	ND	ND	ND	SW846 6010B	mg/L	0.01
Chromium (Cr)	ND	ND	ND	SW846 6010B	mg/L	0.01
Nickel (Ni)	ND	ND	ND	SW846 6010B	mg/L	0.01
Manganese (Mn)	ND	ND	ND	SW846 6010B	mg/L	0.01
Acid, Extraction	09/20/10	09/20/10	09/20/10	SW846 3050	Date	

ND = Not Detected at the indicated Detection Limit

  
 Greg Tejrrian  
 Laboratory Director

\*The results are base upon the sample received. Soil samples are not homogeneous

Cal Tech Environmental Laboratories, Inc. ELAP ID #: 2424

Laboratory: Carl Tech

09-161

# TOTAL AIR ANALYSIS, INC

1210 East 223 rd Street, # 314 Carson, CA 90745 (310) 518 5133 Fax: (310) 518 5107

## CHAIN OF CUSTODY

Page: 1 of: 1

Client: <u>Santa Maria</u>		Project No.: <u>JA-100887</u>		Turnaround Time:		
Contact Person: <u>Ross Legan</u>		Project Name: <u>Flare</u>		<input type="checkbox"/> Same Day <input type="checkbox"/> 24 Hours <input type="checkbox"/> 48 Hours <input checked="" type="checkbox"/> Normal		
tel: _____		Project Manager: <u>RPL</u>		Lowest Detection Limits (0.1 ug)		
fax: _____		P.O. Number: _____		Remarks		
Total Air ID #	Client Sample ID	Summa Canister #	Date	Type of Sample	Lab ID Number	Remarks
	Run #1 - Rinse + Filter	-	9/9/10	Gas		
	" 1 - Impinger	-				750
	Run #2 - Rinse + Filter	-				2670
	" 2 - Impinger	-	9/10/10			750
	Run #3 - Rinse + Filter	-				2710
	" 3 - Impinger	-				750
	FIELD Blank Rinse + Filter	-				2665
	" " - Impinger	-				150
	Reagent Blank (5% H <sub>2</sub> O <sub>2</sub> / 10% H <sub>2</sub> O)	-				75
	Reagent " (0.1N NTRAC)	-				75
Relinquished by: (signature)		Date/Time		Received by: (signature)		Date/Time
<u>[Signature]</u>		9/13/10 @ 14:00		<u>[Signature]</u>		
Relinquished by: (signature)		Date/Time		Received by: (signature)		Date/Time
<u>[Signature]</u>				<u>R. Yoshida</u>		9-17-10 / 9:30

CARBS 436 - M. News  
 10% Chrome Nitric  
 New Gas Amp  
 Cadmium  
 Value in %

TOTAL AIR ANALYSIS, INC.

Method 5 Field Data Sheet

Facility: SANTA MARIA Stack Dia.: 55" Meier No.: APW 62 Pitot Tube Leak Test: Before: 0 After: 0  
 Source: FLARE Nozzle Size: 0.750 dH@: 0.9969 Assumed Moisture: 14.0%  
 Test Date: 9/9/2010 Pbar: 29.94 Y: 0.000251 Assumed CO<sub>2</sub>: 5.5%  
 Run No.: 1 Static P.: -0.01 Sampling Train Leak Test: Before: 0.000251 After: 7.1°F  
 Project No.: JA-100887 Probe Type: 0.000251 Ambient Temp.: 7.1°F  
 Method: CM3 Y36-APW62 Pitot Coef./No.: 0.59

Time	Sample Point	Delta P	Delta H	DGM Reading	Temperature		Probe	Filter	Pump		Comments
					DGM In	DGM Out			Vacuum	Out Temp	
0	12	.01	1.4	424.0	71	1318		246	-6		
7.5	11	.01	1.4	428.40	70	1331		250	-6		
15	10	.01	1.4	432.65	71	1331		251	-6		
22.5	9	.01	1.4	437.25	71	1335		254	-6		
30	8	.01	1.4	441.70	70	1347		252	-6		
37.5	7	.01	1.4	446.10	71	1311		251	-6		
45	6	.01	1.4	450.50	71	1322		250	-6		
52.5	5	.01	1.4	454.95	71	1334		244	-6		
60	4	.01	1.4	459.40							
	3										
	2										
	1										
0	12	.01	1.4	459.40	70	1342		258	-6		
7.5	11	.01	1.4	463.80	71	1349		259	-6		
15	10	.01	1.4	468.20	70	1346		252	-6		
22.5	9	.01	1.4	472.65	70	1333		250	-6		
30	8	.01	1.4	477.05	71	1346		251	-6		
37.5	7	.01	1.4	481.50	71	1340		252	-6		
45	6	.01	1.4	485.90	70	1335		250	-6		
52.5	5	.01	1.4	490.31	70	1342		246	-6		
60	4	.01	1.4	494.65	70	1342					
	3										
	2										
	1										

TOTAL AIR ANALYSIS, INC.

Method 5 Field Data Sheet

Facility: Santa Maria Stack Dia.: 55 Meter No.: Apex #2 Pilot Tube Leak Test: 0.0  
 Source: Flare Nozzle Size: 0.750 dH@: 0.0 After: 0.0  
 Test Date: 9/9/10 Pbar: 29.94 Y: 0.9969 Assumed Moisture: 0.0  
 Run No.: 2 Static P: -0.01 Sampling Train Leak Test: Assumed O<sub>2</sub>  
 Project No.: Quartz Before: 0.005025 Assumed CO<sub>2</sub>: 0.005020  
 Method: Metals - 436 Pilot Coef.No.: 0.99 After: 0.005020 Ambient Temp: 0.0

Time	Sample Point	Delta P	Delta H	DGM Reading	Temperature		Filter	Pump Vacuum	Imp. Out Temp.	Comments
					DGM In	DGM Out				
0	12	.01	1.5	497.02	68	210	-16			
7.5	11	.01	1.5	501.89	68	253	-16			
15	10	.01	1.5	506.40	67	255	-16			
22.5	9	.01	1.5	511.88	67	258	-16			
30	8	.01	1.5	516.10	66	250	-16			
37.5	7	.01	1.5	520.90	65	248	-16			
45	6	.01	1.5	525.60	65	245	-16			
52.5	5	.01	1.5	530.40	64		-16			
60	4	.01	1.5	535.15						
<hr/>										
0	12	.01	1.5	535.15	64	272	-16			
7.5	11	.01	1.5	535.90	63	250	-16			
15	10	.01	1.5	544.65	63	254	-16			
22.5	9	.01	1.5	549.35	62	251	-16			
30	8	.01	1.5	554.10	62	247	-16			
37.5	7	.01	1.5	558.95	61	245	-16			
45	6	.01	1.5	563.68	61	251	-16			
52.5	5	.01	1.5	568.39	60		-16			
60	4	.01	1.5	573.15						
3										
2										
1										

TOTAL AIR ANALYSIS, INC.

Method 5 Field Data Sheet

Facility: San Joaquin Stack Dia.: 55.0 Meter No.: APAC #2 Pilot Tube Leak Test: 0.0  
 Source: Flare Nozzle Size: 0.750 dH@: - Before: 0.0 After: 0.0  
 Test Date: 9/10/10 Pbar: 29.97 Y: 0.9969 Assumed Moisture: 0.0  
 Run No.: 3 Static P: -0.01 Sampling Train Leak Test: Assumed O<sub>2</sub>  
 Project No.: JA 100007 Probe Type: Quartz Before: 0.01 @ 25' Assumed CO<sub>2</sub>: 0.0  
 Method: Meters - 436 Pilot Coef. No.: 0.99 After: 0.005 @ 18" Ambient Temp: 0.0

Time	Sample Point	Delta P	Delta H	DGM Reading	Temperature		Stack	DGM In	DGM Out	Probe	Filter	Pump Vacuum	Imp. Out Temp.	Comments
					In	Out								
0	12	0.01	1.5	586.50	67		1349				250	-6		
7.5	11	0.01	1.5	551.42	67		1342				250	-6		
15	10	0.01	1.5	576.35	68		1350				250	-6		
22.5	9	0.01	1.5	601.25	68		1351				251	-6		
30	8	0.01	1.5	606.20	69		1345				251	-6		
37.5	7	0.01	1.5	611.70	69		1345				248	-6		
45	6	0.01	1.5	616.0	69		1357				250	-6		
52.5	5	0.01	1.5	620.95	70		1341				250	-6		
60	4	0.01	1.5	625.90										
	3													
	2													
	1													
0	12	0.01	1.5	625.90	68		1363				251	-6		
7.5	11	0.01	1.5	630.80	68		1373				250	-6		
15	10	0.01	1.5	635.70	68		1355				250	-6		
22.5	9	0.01	1.5	640.65	69		1368				257	-6		
30	8	0.01	1.5	645.55	69		1361				251	-6		
37.5	7	0.01	1.5	650.44	69		1360				251	-6		
45	6	0.01	1.5	655.34	70		1369				251	-6		
52.5	5	0.01	1.5	660.30	70		1373				250	-6		
60	4	0.01	1.5	665.32										
	3													
	2													
	1													

Metals

Total Air Analysis, Inc.  
Impingers Weight Sheet

Facility: Santa Monica  
Source: Flare  
Run No.: 1  
Test Date: 9/9/10  
Operator: JAG

Filter No.: 4.5

Impinger No.	Impinger Solution	Amount (ml)	Impinger Type	Weight	Comments
1	5% HNO <sub>3</sub> / 10% H <sub>2</sub> O <sub>2</sub>	~75	G/S	Final: 759.3	Clear
				Init.: 694.0	
				Net:	
2	5% HNO <sub>3</sub> 10% H <sub>2</sub> O <sub>2</sub>	~100	G/S	Final: 726.7	Clear
				Init.: 700.8	
				Net:	
3	ILU	-	G/S	Final: 600.3	-
				Init.: 591.3	
				Net:	
4	Silica	~300g	MOP. G/S	Final: 884.3	-
				Init.: 854.6	
				Net:	
5				Final:	
				Init.:	
				Net:	
6				Final:	
				Init.:	
				Net:	
7				Final:	
				Init.:	
				Net:	

Total Gain: \_\_\_\_\_

Preparation Date: 9/9/10  
Prepared By: RPL

Recovery Date: 9/9/10  
Recovered By: RPL

# METALS

## Total Air Analysis, Inc. Impingers Weight Sheet

Facility: SANTA MARIA  
 Source: FLARE  
 Run No.: 2  
 Test Date: 09/09/2010  
 Operator: JDL

Filter No.: Yes

Impinger No.	Impinger Solution	Amount (ml)	Impinger Type	Weight	Comments
1	5% HNO <sub>3</sub> 10% H <sub>2</sub> O <sub>2</sub>	175	G/S	Final: 766.7	Clean
				Init.: 636.2	
				Net:	
2	5% HNO <sub>3</sub> 10% H <sub>2</sub> O <sub>2</sub>	175	G/S	Final: 706.9	Clean
				Init.: 678.5	
				Net:	
3	KO	-	G/S	Final: 600.5	-
				Init.: 600.3	
				Net:	
4	SILICA	-	G/S	Final: 898.8	-
				Init.: 889.3	
				Net:	
5				Final:	
				Init.:	
				Net:	
6				Final:	
				Init.:	
				Net:	
7				Final:	
				Init.:	
				Net:	

Total Gain: \_\_\_\_\_

Preparation Date: 9/9/10  
 Prepared By: RPL

Recovery Date: 9/10/10  
 Recovered By: RPL



METALS

Total Air Analysis, Inc.  
Impingers Weight Sheet

Facility: SANTA  
Source: Flare  
Run No.: 3  
Test Date: 9/10/10  
Operator: JAG

Filter No.: YES

Impinger No.	Impinger Solution	Amount (ml)	Impinger Type	Weight	Comments
1	5% HNO <sub>3</sub> 10% H <sub>2</sub> O <sub>2</sub>	~75	6/S	Final: 757.8 Init.: 685.9 Net:	Clear
2	5% HNO <sub>3</sub> 10% H <sub>2</sub> O <sub>2</sub>	~100	6/S	Final: 707.0 Init.: 600.4 Net:	Clear
3	KO	—	6/S	Final: 601.1 Init.: 594.3 Net:	—
4	Silica	~300gms	Mod. 6/S	Final: 906.3 Init.: 898.8 Net:	—
5				Final: Init.: Net:	
6				Final: Init.: Net:	
7				Final: Init.: Net:	

Total Gain: \_\_\_\_\_

Preparation Date: 9/10/10  
Prepared By: RPL

Recovery Date: 9/10/10  
Recovered By: RPL

## **Appendix F**

### ***EPA Method 18 – Acrylonitrile, 1,4-Dioxane*** **Calculations and Analytical Results**

## EPA Method 18 Data Calculation Sheet

**Facility:** Santa Maria Landfill  
**Source:** Flare  
**Load:** Normal  
**Start Date:** 9/9/2010

Parameter/Run No.	Units	1	2	3	Average
Stack Gas Flowrate	dscfm	3,320	3,238	3,288	3,282
Oxygen Concentration	%	14.08	14.08	14.12	14.09
Acrylonitrile	ppbv	nd	2.3	2.3	2.30
Acrylonitrile, Emissions	lb/hr	nd	0.000063	0.000064	0.000063
Acrylonitrile, Emissions					
<b>1,4-Dioxane</b>	ppbv	nd	1.4	1.4	1.40
1,4-Dioxane, Emissions	lb/hr	nd	0.000065	0.000064	0.000064
1,4-Dioxane, Emissions					

All values are Non-Detect. Reporting limits used for calculation purposes.

## LABORATORY REPORT

September 20, 2010

Russ Logan  
Total Air Analysis, Inc.  
1210 E. 223rd Street, Suite 314  
Carson, CA 90745

**RE: Flare at SM / JA-100887**

Dear Russ:

Enclosed are the results of the samples submitted to our laboratory on September 10, 2010. For your reference, these analyses have been assigned our service request number P1003340.

All analyses were performed according to our laboratory's NELAP-approved quality assurance program. The test results meet requirements of the current NELAP standards, where applicable, and except as noted in the laboratory case narrative provided. For a specific list of NELAP-accredited analytes, refer to the certifications section at [www.caslab.com](http://www.caslab.com). Results are intended to be considered in their entirety and apply only to the samples analyzed and reported herein. Your report contains 10 pages.

Columbia Analytical Services, Inc. is certified by the California Department of Health Services, NELAP Laboratory Certificate No. 02115CA; Arizona Department of Health Services, Certificate No. AZ0694; Florida Department of Health, NELAP Certification E871020; New Jersey Department of Environmental Protection, NELAP Laboratory Certification ID #CA009; New York State Department of Health, NELAP NY Lab ID No: 11221; Oregon Environmental Laboratory Accreditation Program, NELAP ID: CA20007; The American Industrial Hygiene Association, Laboratory #101661; United States Department of Defense Environmental Laboratory Accreditation Program (DoD-ELAP), Certificate No. L10-3; Pennsylvania Registration No. 68-03307; TX Commission of Environmental Quality, NELAP ID T104704413-09-TX; Minnesota Department of Health, Certificate No. 11495AA; Washington State Department of Ecology, ELAP Lab ID: C946. Each of the certifications listed above have an explicit Scope of Accreditation that applies to specific matrices/methods/analytes; therefore, please contact me for information corresponding to a particular certification.

If you have any questions, please call me at (805) 526-7161.

Respectfully submitted,

**Columbia Analytical Services, Inc.**



Kelly Horiuchi  
Laboratory Director

Page  
1 of 10

Client: Total Air Analysis, Inc.  
Project: Flare at SM / JA-100887

CAS Project No: P1003340

---

### CASE NARRATIVE

The samples were received intact under chain of custody on September 10, 2010 and were stored in accordance with the analytical method requirements. Please refer to the sample acceptance check form for additional information. The results reported herein are applicable only to the condition of the samples at the time of sample receipt.

#### Volatile Organic Compound Analysis

The samples were analyzed for selected volatile organic compounds in accordance with EPA Method TO-15 from the Compendium of Methods for the Determination of Toxic Organic Compounds in Ambient Air, Second Edition (EPA/625/R-96/010b), January, 1999. The analytical system was comprised of a gas chromatograph/mass spectrometer (GC/MS) interfaced to a whole-air preconcentrator. According to the method, the use of Tedlar bags is considered a method modification.

---

*The results of analyses are given in the attached laboratory report. All results are intended to be considered in their entirety, and Columbia Analytical Services, Inc. (CAS) is not responsible for utilization of less than the complete report.*

Client: Total Air Analysis, Inc.  
Project: Flare at SM/100887

Service Request: P1003340

SAMPLE CROSS-REFERENCE

<u>SAMPLE #</u>	<u>CLIENT SAMPLE ID</u>	<u>DATE</u>	<u>TIME</u>
P1003340-001	SM-Flare #1	9/9/10	14:00
P1003340-002	SM-Flare #2	9/9/10	15:00
P1003340-003	SM-Flare #3	9/9/10	15:45







COLUMBIA ANALYTICAL SERVICES, INC.

RESULTS OF ANALYSIS

Page 1 of 1

Client: Total Air Analysis, Inc.  
Client Sample ID: SM-Flare #1 Rog  
Client Project ID: Flare at SM / JA-100887

CAS Project ID: P1003340  
CAS Sample ID: P1003340-001

Test Code: EPA TO-15 Modified  
Instrument ID: Tekmar AUTOCAN/Agilent 5973inert/6890N/MS9  
Analyst: Wida Ang  
Sampling Media: 1.0 L Tedlar Bag  
Test Notes:

Date Collected: 9/9/10  
Date Received: 9/10/10  
Date Analyzed: 9/10/10  
Volume(s) Analyzed: 0.10 Liter(s)

CAS #	Compound	Result $\mu\text{g}/\text{m}^3$	MRL $\mu\text{g}/\text{m}^3$	Result ppbV	MRL ppbV	Data Qualifier
107-13-1	Acrylonitrile	ND	5.0	ND	2.3	
123-91-1	1,4-Dioxane	ND	5.0	ND	1.4	

ND = Compound was analyzed for, but not detected above the laboratory reporting limit.

MRL = Method Reporting Limit - The minimum quantity of a target analyte that can be confidently determined by the referenced method.

Verified By: \_\_\_\_\_ Date: 9/15/10  
TO15scan.xls - NL - PageNo.:

# COLUMBIA ANALYTICAL SERVICES, INC.

## RESULTS OF ANALYSIS

Page 1 of 1

**Client:** Total Air Analysis, Inc.  
**Client Sample ID:** SM-Flare #2 Rog  
**Client Project ID:** Flare at SM / JA-100887

CAS Project ID: P1003340  
CAS Sample ID: P1003340-002

**Test Code:** EPA TO-15 Modified  
**Instrument ID:** Tekmar AUTOCAN/Agilent 5973inert/6890N/MS9  
**Analyst:** Wida Ang  
**Sampling Media:** 1.0 L Tedlar Bag  
**Test Notes:**

**Date Collected:** 9/9/10  
**Date Received:** 9/10/10  
**Date Analyzed:** 9/10/10  
**Volume(s) Analyzed:** 0.10 Liter(s)

CAS #	Compound	Result $\mu\text{g}/\text{m}^3$	MRL $\mu\text{g}/\text{m}^3$	Result ppbV	MRL ppbV	Data Qualifier
107-13-1	Acrylonitrile	ND	5.0	ND	2.3	
123-91-1	1,4-Dioxane	ND	5.0	ND	1.4	

ND = Compound was analyzed for, but not detected above the laboratory reporting limit.

MRL = Method Reporting Limit - The minimum quantity of a target analyte that can be confidently determined by the referenced method.

COLUMBIA ANALYTICAL SERVICES, INC.

RESULTS OF ANALYSIS

Page 1 of 1

Client: Total Air Analysis, Inc.  
Client Sample ID: SM-Flare #3 Rog  
Client Project ID: Flare at SM / JA-100887

CAS Project ID: P1003340  
CAS Sample ID: P1003340-003

Test Code: EPA TO-15 Modified  
Instrument ID: Tekmar AUTOCAN/Agilent 5973inert/6890N/MS9  
Analyst: Wida Ang  
Sampling Media: 1.0 L Tedlar Bag  
Test Notes:

Date Collected: 9/9/10  
Date Received: 9/10/10  
Date Analyzed: 9/10/10  
Volume(s) Analyzed: 0.10 Liter(s)

CAS #	Compound	Result $\mu\text{g}/\text{m}^3$	MRL $\mu\text{g}/\text{m}^3$	Result ppbV	MRL ppbV	Data Qualifier
107-13-1	Acrylonitrile	ND	5.0	ND	2.3	
123-91-1	1,4-Dioxane	ND	5.0	ND	1.4	

ND = Compound was analyzed for, but not detected above the laboratory reporting limit.

MRL = Method Reporting Limit - The minimum quantity of a target analyte that can be confidently determined by the referenced method.



**COLUMBIA ANALYTICAL SERVICES, INC.**

SURROGATE SPIKE RECOVERY RESULTS

Page 1 of 1

**Client:** Total Air Analysis, Inc.  
**Client Project ID:** Flare at SM / JA-100887

CAS Project ID: P1003340

**Test Code:** EPA TO-15 Modified  
**Instrument ID:** Tekmar AUTOCAN/Agilent 5973inert/6890N/MS9  
**Analyst:** Wida Ang  
**Sampling Media:** 1.0 L Tedlar Bag(s)  
**Test Notes:**

**Date(s) Collected:** 9/9/10  
**Date(s) Received:** 9/10/10  
**Date(s) Analyzed:** 9/10/10

Client Sample ID	CAS Sample ID	1,2-Dichloroethane-d4	Toluene-d8	Bromofluorobenzene	Acceptance Limits	Data Qualifier
		Percent Recovered	Percent Recovered	Percent Recovered		
Method Blank	P100910-MB	98	99	104	70-130	
SM-Flare #1 Rog	P1003340-001	104	92	97	70-130	
SM-Flare #2 Rog	P1003340-002	104	92	97	70-130	
SM-Flare #3 Rog	P1003340-003	106	92	97	70-130	

Surrogate percent recovery is verified and accepted based on the on-column result.  
 Reported results are shown in concentration units and as a result of the calculation, may vary slightly from the on-column percent recovery.

## **Appendix G**

### ***EPA Method 19 - Volume Flow Calculation*** **Analytical Results and Fuel Meter Calibration**

## EPA Method 19, Stack Gas Flowrate Calculation

**Facility:** Santa Maria Landfill  
**Source:** Flare  
**Load:** Normal  
**Start Date:** 9/9/2010

Run No	Time		O <sub>2</sub> (%)	Fuel Flow (scfm)	HHV (btu/scf)	F Factor (sdcf/MMBtu)	System Flow (scfm)	Heat Input (Mmbtu/hr)
	Start	End						
1	14:42	16:09	14.08	239	453	9,581	3,180	6.50
2	18:54	20:48	14.08	235	453	9,581	3,126	6.39
3	15:37	17:23	14.12	225	453	9,581	3,008	6.12
4	20:10	21:30	13.84	250	449	9,611	3,199	6.75
5	11:17	12:29	13.88	251	449	9,611	3,220	6.75
6	14:44	15:45	13.89	233	449	9,611	3,004	6.29

Flow Rate = Fuel Flow Rate x F Factor x HHV/1000000 x 20.9/(20.9 - O<sub>2</sub> conc)

**CLIENT:** Total Air Analysis, Inc.  
**CLIENT PROJ NO:** JA-100887  
**LABORATORY NO:** 10-727  
**SAMPLING DATE:** September 10 & 11, 2010  
**RECEIVING DATE:** September 13, 2010  
**ANALYSIS DATE:** September 13, 2010  
**REPORT DATE:** September 15, 2010

**Laboratory Analysis Report**  
**Analysis Method: ASTM-3588-98**

Analyte, Units	Sample ID	Fuels Sample #1	Fuel Sample #2
	Sample Date	9/10/2010	9/11/2010
	Lab ID	25610-11	25610-12
	Units	Mole %	Mole %
Methane, %	45	44	
Ethane, %	<0.1	<0.1	
Ethylene, %	<0.1	<0.1	
Propane, %	<0.1	<0.1	
Propylene, %	<0.1	<0.1	
i-Butane, %	<0.1	<0.1	
n-Butane, %	<0.1	<0.1	
1-Butene, %	<0.1	<0.1	
i-Butylene, %	<0.1	<0.1	
trans-2-Butene, %	<0.1	<0.1	
cis-2-Butene, %	<0.1	<0.1	
i-Pentane, %	<0.1	<0.1	
n-Pentane, %	<0.1	<0.1	
2,2-Dimethyl Butane, %	<0.1	<0.1	
2,3-Dimethyl Butane, %	<0.1	<0.1	
2-Methyl Pentane, %	<0.1	<0.1	
3-Methyl Pentane, %	<0.1	<0.1	
n-Hexane, %	<0.1	<0.1	
C6+, %	<0.1	<0.1	
CO <sub>2</sub> , %	32	27	
CO, %	<0.1	<0.1	
O <sub>2</sub> , %	1.9	1.9	
N <sub>2</sub> , %	21	26	
H <sub>2</sub> , %	<0.1	<0.1	
H <sub>2</sub> S, %	<0.1	<0.1	
<b>Average Molecular Weight</b>	<b>27.821</b>	<b>27.135</b>	
<b>Total Wt.% Adjusted Sp. Gravity</b>	<b>0.9605</b>	<b>0.9369</b>	
<b>Compressibility Factor (14.696 Psi, 60 F)</b>	<b>0.9979</b>	<b>0.9980</b>	
<b>NET BTU/Cub. Ft</b>	<b>408</b>	<b>404</b>	
<b>GROSS BTU/Cub. Ft</b>	<b>453</b>	<b>449</b>	
CHONS	%	%	
Carbon	33	32	
Hydrogen	6.5	6.6	
Oxygen	39	34	
Nitrogen	21	27	
Sulfur	<0.1	<0.1	
<b>Dry F Factor (60 F, 1 Atm);</b>	<b>9581</b>	<b>9611</b>	
<b>SDCF/MMBTU, ASTM 3588</b>			

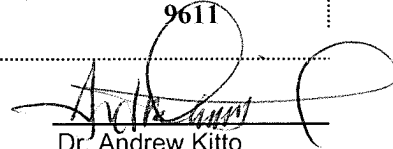
  
 Dr. Andrew Kitto  
 President





# CALIBRATION CERTIFICATION

We certify that the calibration accuracies listed below are obtained on equipment, and with methods, that can be traced directly to the US National Institute of Standards and Technology.

FLOWRATE READOUT ACCURACY:  $\pm 1\%$  Full Scale

PRESSURE TESTED AT:

METER SERIAL NUMBER: 2006153

MODEL NUMBER: 62-9/9500

*The calibration listed above was performed under the following conditions:*

0 to 1200 SCFM LANDFILL GAS

40 to 200° F

0 to 15 PSIG

6" SCH 10 SS Line  FLARE 1

Signature  Date: May 6, 2009

**THERMAL INSTRUMENT COMPANY, INC.**

217 Sterner Mill Road, Trevoise, PA 19053

Phone: 215-355-8400 Fax: 215-355-1789

Web: [www.thermalinstrument.com](http://www.thermalinstrument.com)

## **Appendix H**

*EPA Method 26 – Acids, HCL, and HF*  
**Calculation Spreadsheets, Analytical Results, and Field Data Sheets**

## EPA Method 26 - Acid Emissions Determination

Facility: Santa Maria Landfill  
 Source: Flare  
 Load: Normal  
 Start Date: 9/9/2010

Operator: JDG  
 Review: R. Logan

Data Entry	Symbol	Units	Flare		
Run Number			1	2	3
Average Meter Temperature	Tm	degrees F	63.3	71.8	76.5
Barometric Pressure	Pbar	in. Hg	29.97	29.97	29.97
Avg. Delta H	dH	in. H2O	1.60	1.60	1.60
Gas Sample Volume	Vm	cubic ft.	84.13	80.62	81.31
Meter Calibration Factor	Y	-	0.9986	0.9986	0.9986
Total Sampling Time	min	minutes	120	120	120
Total Impinger Gain	Ww	grams	142.3	142.2	135.8

### Concentration

Total Sample Catch	sample	mls/sample	303	305	305
Stack Gas HF Concentration	HF	mg/sample	0.86	0.44	0.39
Stack Gas HCl Concentration	HCl	mg/sample	0.009	0.009	0.009

Calculated Data	Symbol	Units	Flare		
Run Number	-	-	1	2	3
Avg. Meter Temperature, $T_m = F_m + 460$	Tm,r	degrees R	523.3	531.8	536.5
Gas Sample Volume @ Standard Conditions, $V_{mStd} = 17.647 Y (V_m/T_m) (P_{bar} + dH/13.6)$	VmStd	dscf	85.25	80.39	80.36
Volume of Water Vapor, $V_{wStd} = 0.04707 * W_w$	VwStd	dscf	6.70	6.69	6.39
Moist. Fraction, $B_{ws} = V_{wStd}/(V_{mStd} + V_{wStd})$	Bws	%	0.07	0.08	0.07
HF conc = $mg_{sample} * 386.94 * 1000 / (453.6 * 20.006 * V_{mStd})$	HF conc	ppm	0.430	0.233	0.207
HCl conc = $mg_{sample} * 386.94 * 1000 / (453.6 * 36.45 * V_{mStd})$	HCl conc	ppm	0.002	0.003	0.003
Volume flow rate	Qsd	dscfm	3199	3220	3004
Mass Emissions, lb/hr = $ppm * dscfm * MW(20) * 1.583 * 10^{-7}$	HF	lb/hr	0.004	0.002	0.002
Mass Emissions, lb/hr = $ppm * dscfm * MW(17) * 1.583 * 10^{-7}$	HCl	lb/hr	0.00002	0.00002	0.00002

<b>CLIENT</b>	<b>Total Air Analysis</b>
<b>LABORATORY NO:</b>	<b>10-743</b>
<b>CLIENT PROJECT NO:</b>	<b>Santa Maria Flare</b>
<b>SAMPLING DATE:</b>	September 10, 2010
<b>RECEIVING DATE:</b>	September 16, 2010
<b>ANALYSIS DATE:</b>	September 20, 2010
<b>REPORT DATE:</b>	September 22, 2010

### Laboratory Analysis Report

Analysis Method	EPA Method 26		
Detection Limit	0.4 ug/sample		
Total Air Analysis Sample ID	Sample Vol (ml)	ug/ml	HF mg/sample
Run #1, Impinger	303	2.74	0.86
Run #2, Impinger	305	1.42	0.44
Run #3, Impinger	305	1.24	0.39
Field Blank	130	<0.02	<0.002
Reagent Blank	133	<0.02	<0.002

Analysis Method	EPA Method 26		
Detection Limit	0.4 ug/sample		
Total Air Analysis Sample ID	Sample Vol (ml)	ug/ml	HCl mg/sample
Run #1, Impinger	303	<0.03	<0.009
Run #2, Impinger	305	<0.03	<0.009
Run #3, Impinger	305	<0.03	<0.009
Field Blank	130	<0.03	<0.004
Reagent Blank	133	<0.03	<0.004

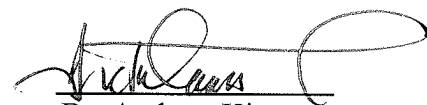

Dr. Andrew Kitto  
 President



www.quantumairlab.com

1210 E. 223rd Street, Suite #314 • Carson, California 90745 • 310/830-2226 • Fax 310/830-2227

**CLIENT** Total Air Analysis  
**LABORATORY NO:** 10-743  
**CLIENT PROJECT NO:** Santa Maria Flare  
**SAMPLING DATE:** September 10, 2010  
**RECEIVING DATE:** September 16, 2010  
**ANALYSIS DATE:** September 20, 2010  
**REPORT DATE:** September 22, 2010

**DUPLICATE ANALYSES**

<b>Analysis Method</b>	<b>EPA Method 26</b>				
<b>Detection Limit</b>	<b>0.2 ug/sample</b>				
<b>Total Air Analysis</b>		<b>Analysis #1</b>	<b>Analysis #2</b>	<b>Mean</b>	<b>% Difference</b>
<b>Sample ID</b>	<b>Analyte</b>	<b>mg/sample</b>	<b>mg/sample</b>	<b>mg/sample</b>	<b>from the Mean</b>
Run #3, Impinger	HF	0.39	0.38	0.38	1.1%

N/A: Not Applicable

Dr. Andrew Kitto  
President

Laboratory: Quantum

10-743

# TOTAL AIR ANALYSIS, INC

1210 East 223 rd Street, # 314 Carson, CA 90745 (310) 518 5133 Fax: (310) 518 5107

## CHAIN OF CUSTODY

Page: 1 of: 1

Client: <u>Santa Maria Flare</u>		Project No.: <u>SA-100887</u>		Analysis		Turnaround Time:			
Contact Person: <u>Russ Leppan</u>		Project Name: <u>Flare</u>		<input type="checkbox"/> Same Day <input type="checkbox"/> 24 Hours <input type="checkbox"/> 48 Hours <input checked="" type="checkbox"/> Normal		<div style="border: 1px solid black; padding: 5px; display: inline-block;">         Lowest          Detection          Limit       </div>			
tel: _____		Project Manager: <u>RPL</u>							
fax: _____		P.O. Number: _____		<div style="transform: rotate(-45deg); border: 1px solid black; padding: 5px; display: inline-block;">           EPA M-26            HCL + HF         </div>		Remarks <u>Transfer Case - H2O</u>			
Total Air ID #	Client Sample ID	Summa Canister #	Date					Type of Sample	Lab ID Number
	<u>Run #1 - Impinger</u>	<u>--</u>	<u>9/10/10</u>					<u>Water</u>	<input checked="" type="checkbox"/>
	<u>Run #2 - Impinger</u>	<u>--</u>	<u>9/11/10</u>					<u>↓</u>	<input checked="" type="checkbox"/>
	<u>Run #3 - Impinger</u>	<u>--</u>	<u>9/11/10</u>					<u>↓</u>	<input checked="" type="checkbox"/>
	<u>Field Blank</u>	<u>--</u>	<u>9/11/10</u>					<u>↓</u>	<input checked="" type="checkbox"/>
	<u>Reagent Blank</u>	<u>--</u>	<u>9/11/10</u>					<u>↓</u>	<input checked="" type="checkbox"/>
Retrieved by: (signature)		Date/Time		Received by: (signature)		Date/time			
<u>[Signature]</u>		<u>9/13/10 @ 10:05</u>		<u>[Signature]</u>		<u>9/16/10 12:23</u>			
Retrieved by: (signature)		Date/Time		Received by: (signature)		Date/time			
<u>[Signature]</u>				<u>[Signature]</u>					

TOTAL AIR ANALYSIS, INC.

Method 5 Field Data Sheet

Facility: Santa Monica Stack Dia.: 55 Meter No.: AP001 Pitot Tube Leak Test: Before: After:  
 Source: FLARE Nozzle Size: 0.750 dH@: 0.9986 Assumed Moisture:  
 Test Date: 9/10/10 Pbar: 29.97 Y: 0.01025 Assumed O<sub>2</sub>:  
 Run No.: 1 Static P: 0.01 Sampling Train Leak Test: 0.01020 Ambient Temp.:  
 Project No.: QANW7 Before: After:  
 Method: EPA 26 - Acids Pitot Coef./No.:

Time	Sample Point	Delta P	Delta H	DGM Reading	Stack	Temperature		Probe	Filter	Pump Vacuum	Imp. Out Temp.	Comments
						DGM In	DGM Out					
0	12		1.6	525.15			66	-	250	-7	41	
10	11		1.6	537.50			66	-	250	-7	40	
20	10		1.6	541.18			66	-	250	-7	40	
30	9		1.6	550.12			65	-	250	-7	40	
40	8		1.6	556.25			65	-	244	-7	40	
50	7		1.6	561.11			65	-	250	-7	40	
60	6		1.6	567.50			64	-	250	-7	40	
	5											
	4											
	3											
	2											
	1											
0	12		1.6	527.50			67	-	250	-7	39	
10	11		1.6	542.13			61	-	250	-7	39	
20	10		1.6	548.23			60	-	250	-7	39	
30	9		1.6	553.12			60	-	250	-7	39	
40	8		1.6	557.33			60	-	250	-7	39	
50	7		1.6	567.22			60	-	250	-7	39	
60	6		1.6	607.21			60	-	250	-7	39	
	5											
	4											
	3											
	2											
	1											



TOTAL AIR ANALYSIS, INC.

Method 5 Field Data Sheet

Facility: SANTA MARIA Stack Dia.: 55" Meter No.: APX1 Pilot Tube Leak Test: After:  
 Source: PURE Nozzle Size: 0.750 dH@: 0.9986 Before: Assumed Moisture:  
 Test Date: 05/11/2010 Pbar: 29.98 Y: 0.9986 Assumed Moisture:  
 Run No.: 2 Static P: - Sampling Train Leak Test: Assumed O<sub>2</sub>:  
 Project No.: DLRZ Before: 0.01025 Assumed CO<sub>2</sub>:  
 Method: EPA 26 - ACS After: 0.01022 Ambient Temp:

Time	Sample Point	Distr. P.	Delta H	DGM Reading	Temperature		Filter	Pump		Comments
					DGM In	DGM Out		Yacuum	Imp. Out Temp	
0	12		1.6	612.47	69	-	251	-11	54	
10	11		1.6	618.15	67	-	251	-11	53	
20	10		1.6	624.13	69	-	250	-11	53	
30	9		1.6	631.50	69	-	250	-11	57	
40	8		1.6	637.33	70	-	251	-11	57	
50	7		1.6	643.0	77	-	250	-11	60	
60	6		1.6	649.16	77	-	250	-11	60	
	5									
	4									
	3									
	2									
	1									
0	12		1.6	649.16	73	-	250	-11	61	
10	11		1.6	655.16	74	-	251	-11	62	
20	10		1.6	663.33	74	-	251	-11	62	
30	9		1.6	670.10	74	-	250	-11	63	
40	8		1.6	677.18	74	-	250	-11	64	
50	7		1.6	684.70	76	-	251	-11	64	
60	6		1.6	693.12	76	-	250	-11	64	
	5									
	4									
	3									
	2									
	1									

TOTAL AIR ANALYSIS, INC.

Method 5 Field Data Sheet

Facility: SANTA MARIA Stack Dia.: 1 Meter No.: None  
 Source: FAVE Nozzle Size: 1/2" dH@: 0.750  
 Test Date: 07/11/2010 Pbar: 29.98 Y: 0.9986  
 Run No.: 3 Static P: -0.01 Sampling Train Leak Test: Assumed Moisture:  
 Project No.: QUARTZ Before: 0.01225° Assumed O<sub>2</sub>: Assumed CO<sub>2</sub>:  
 Method: GRA20 AC10 Pilot Coef./No.: - After: 0.01022° Ambient Temp.:

Time	Sample Point	Delta P	Delta H	DGM Reading	Stack	Temperature		Filter	Pump Vacuum	Imp Out Temp	Comments
						DGM In	DGM Out				
0	12		1.6	693.86	1386	77		250	-6		
10	11		1.6	700.19	1702	77		250	-6		
20	10		1.6	706.52	1389	76		249	-6		
30	9		1.6	712.85	1404	76		249	-6		
40	8		1.6	719.15	1369	76		251	-6		
50	7		1.6	725.48	1284	75		250	-6		
60	6		1.6	732.80	1244	75		249	-6		
	5							278			
	4							270			
	3							282			
	2										
	1										
<hr/>											
0	12		1.6	739.50		77		251	-6		
10	11		1.6	744.18		77		251	-6		
20	10		1.6	750.51		77		250	-6		
30	9		1.6	756.81		77		250	-6		
40	8		1.6	763.11		77		251	-6		
50	7		1.6	769.44		77		250	-6		
60	6		1.6	775.77		77		250	-6		
	5										
	4										
	3										
	2										
	1										

# Total Air Analysis, Inc.

## Impingers Weight Sheet

Facility: Santa Maria  
 Source: Flare  
 Run No.: \_\_\_\_\_  
 Test Date: 9/10/10  
 Operator: JDG

Filter No.: Yes

Acids - EPA 26

Impinger No.	Impinger Solution	Amount (ml)	Impinger Type	Weight	Comments
1	0.1N H <sub>2</sub> SO <sub>4</sub>	~75mls	6/S	Final: 776.7	Clear
				Init.: 670.3	
				Net:	
2	0.1N H <sub>2</sub> SO <sub>4</sub>	~75mls	6/S	Final: 698.5	Clear
				Init.: 678.8	
				Net:	
3	K <sub>2</sub> O	—	6/S	Final: 622.9	—
				Init.: 620.8	
				Net:	
4	Silica	~300	Wop. 6/S	Final: 906.8	—
				Init.: 892.7	
				Net:	
5				Final:	
				Init.:	
				Net:	
6				Final:	
				Init.:	
				Net:	
7				Final:	
				Init.:	
				Net:	

Total Gain: \_\_\_\_\_

Preparation Date: 9/10/10  
 Prepared By: RPL

Recovery Date: 9/10/10  
 Recovered By: RPL

# Total Air Analysis, Inc.

## Impingers Weight Sheet

Facility: \_\_\_\_\_

Source: \_\_\_\_\_

Run No.: \_\_\_\_\_

Test Date: \_\_\_\_\_

Operator: \_\_\_\_\_

Santa Maria

Flare

2

9/11/10

JOB

Filter No.: yes

Acids - EPA 26

Impinger No.	Impinger Solution	Amount (ml)	Impinger Type	Weight	Comments
1	0.1 N H <sub>2</sub> SO <sub>4</sub>	~75mls	G/S	Final: 756.4	Clear
				Init.: 667.8	
				Net:	
2	0.1 N H <sub>2</sub> SO <sub>4</sub>	~75mls	G/S	Final: 698.8	Clear
				Init.: 672.2	
				Net:	
3	KO	-	G/S	Final: 629.2	-
				Init.: 623.0	
				Net:	
4	Silica	~300gms	MODS G/S	Final: 853.3	-
				Init.: 832.5	
				Net:	
5				Final:	
				Init.:	
				Net:	
6				Final:	
				Init.:	
				Net:	
7				Final:	
				Init.:	
				Net:	

Total Gain: \_\_\_\_\_

Preparation Date: \_\_\_\_\_

Prepared By: \_\_\_\_\_

Recovery Date: \_\_\_\_\_

Recovered By: \_\_\_\_\_

9/11/10

RPL

9/11/10

RPL

# Total Air Analysis, Inc.

## Impingers Weight Sheet

Facility: Santa Maria

Source: Flare

Run No.: 3

Test Date: 9/11/10

Operator: SDG

Filter No.: yes

Acidos - EPA 26

Impinger No.	Impinger Solution	Amount (ml)	Impinger Type	Weight	Comments
1	0.1N H <sub>2</sub> SO <sub>4</sub>	~75mls	G/S	Final: 771.0	Clean
				Init.: 671.3	
				Net:	
2	0.1N H <sub>2</sub> SO <sub>4</sub>	~75mls	G/S	Final: 699.4	Clean
				Init.: 678.5	
				Net:	
3	K <sub>2</sub> O	-	G/S	Final: 632.7	-
				Init.: 629.2	
				Net:	
4	Silica	~300gr	wet G/S	Final: 865.0	✓
				Init.: 853.3	
				Net:	
5				Final:	
				Init.:	
				Net:	
6				Final:	
				Init.:	
				Net:	
7				Final:	
				Init.:	
				Net:	

Total Gain: \_\_\_\_\_

Preparation Date: 9/11/10

Prepared By: RPL

Recovery Date: 9/11/10

Recovered By: RPL

## **Appendix I**

### **Facility Flare Process Data**

Date	Time	Ch. Tag Unit sec	CH001		CH003		CH005		
			FLARE 1 TEMP		FLARE 1 FLOW		LFG FLOW		
			°F		SCFM		SCFM		
			MIN	MAX	MIN	MAX	MIN	MAX	
2010/09/09	14:30:00		0.000	1414	1422	225.3	229.5	605.3	653.5
2010/09/09	14:31:00		0.000	1414	1478	225.3	339.6	634.6	683.1
2010/09/09	14:32:00		0.000	1451	1480	235.1	239.2	624.9	692.9
2010/09/09	14:33:00		0.000	1422	1451	234.5	238.3	624.9	673.3
2010/09/09	14:34:00		0.000	1418	1422	233.6	238.3	626.5	655.2
2010/09/09	14:35:00		0.000	1418	1420	231.6	236.2	608.3	650.2
2010/09/09	14:36:00		0.000	1420	1428	231.8	236.7	624.1	663.3
2010/09/09	14:37:00		0.000	1428	1450	231.8	236.5	630.0	659.4
2010/09/09	14:38:00		0.000	1450	1461	233.1	236.5	619.3	664.3
2010/09/09	14:39:00		0.000	1446	1458	232.5	236.5	619.3	663.1
2010/09/09	14:40:00		0.000	1373	1451	232.5	340.0	611.6	684.5
2010/09/09	14:41:00		0.000	1385	1494	237.8	272.3	639.5	672.8
2010/09/09	14:42:00		0.000	1426	1472	238.0	240.9	643.1	681.6
2010/09/09	14:43:00		0.000	1414	1426	236.2	240.6	631.4	679.8
2010/09/09	14:44:00		0.000	1415	1416	236.0	239.9	624.1	672.5
2010/09/09	14:45:00		0.000	1416	1428	237.7	241.5	628.4	668.8
2010/09/09	14:46:00		0.000	1428	1433	235.7	239.2	620.5	670.9
2010/09/09	14:47:00		0.000	1433	1439	235.1	240.1	617.4	656.7
2010/09/09	14:48:00		0.000	1439	1447	235.6	238.9	625.8	652.3
2010/09/09	14:49:00		0.000	1440	1443	236.0	242.7	617.6	651.7
2010/09/09	14:50:00		0.000	1437	1443	236.2	242.7	619.1	644.5
2010/09/09	14:51:00		0.000	1435	1437	236.0	240.6	620.9	659.1
2010/09/09	14:52:00		0.000	1436	1439	235.6	240.6	620.6	663.4
2010/09/09	14:53:00		0.000	1436	1437	236.0	238.9	605.3	658.4
2010/09/09	14:54:00		0.000	1437	1441	235.7	239.2	616.7	656.1
2010/09/09	14:55:00		0.000	1438	1441	236.9	242.7	615.8	650.2
2010/09/09	14:56:00		0.000	1440	1442	235.1	239.7	623.8	659.0
2010/09/09	14:57:00		0.000	1439	1440	236.0	239.5	620.2	651.4
2010/09/09	14:58:00		0.000	1439	1444	235.3	240.9	610.6	649.9
2010/09/09	14:59:00		0.000	1439	1445	236.2	240.1	615.3	661.9
2010/09/09	15:00:00		0.000	1432	1439	236.2	300.9	613.9	650.8
2010/09/09	15:01:00		0.000	1432	1494	246.2	356.1	627.3	674.9
2010/09/09	15:02:00		0.000	1435	1493	216.0	248.6	620.5	656.1
2010/09/09	15:03:00		0.000	1394	1435	215.7	253.8	588.3	637.6
2010/09/09	15:04:00		0.000	1337	1488	237.8	316.7	621.1	660.4
2010/09/09	15:05:00		0.000	1463	1501	224.2	237.8	615.6	651.7
2010/09/09	15:06:00		0.000	1413	1463	223.4	227.1	598.0	642.6
2010/09/09	15:07:00		0.000	1396	1413	223.0	332.9	598.9	649.3
2010/09/09	15:08:00		0.000	1402	1473	243.6	319.0	601.2	658.9
2010/09/09	15:09:00		0.000	1438	1472	214.5	243.6	616.0	656.4
2010/09/09	15:10:00		0.000	1400	1438	213.4	216.0	586.6	634.9
2010/09/09	15:11:00		0.000	1400	1479	213.4	337.6	620.2	656.1
2010/09/09	15:12:00		0.000	1461	1484	209.0	238.3	609.0	653.5
2010/09/09	15:13:00		0.000	1403	1461	202.8	209.0	590.1	634.0
2010/09/09	15:14:00		0.000	1390	1446	203.0	292.7	593.3	664.2
2010/09/09	15:15:00		0.000	1446	1477	232.5	260.9	613.5	654.4
2010/09/09	15:16:00		0.000	1422	1460	230.7	232.7	621.4	656.3

2010/09/09	15:17:00	0.000	1414	1422	231.3	234.3	606.9	668.4
2010/09/09	15:18:00	0.000	1414	1426	231.0	237.1	635.8	668.4
2010/09/09	15:19:00	0.000	1426	1432	229.8	234.4	624.1	659.0
2010/09/09	15:20:00	0.000	1432	1435	232.9	236.0	623.2	657.9
2010/09/09	15:21:00	0.000	1435	1438	230.7	236.9	620.9	657.0
2010/09/09	15:22:00	0.000	1436	1440	232.5	237.1	620.9	651.7
2010/09/09	15:23:00	0.000	1433	1439	230.7	236.0	601.5	645.4
2010/09/09	15:24:00	0.000	1439	1443	231.8	235.1	608.3	651.9
2010/09/09	15:25:00	0.000	1437	1440	231.8	236.6	609.4	654.1
2010/09/09	15:26:00	0.000	1437	1441	231.3	236.0	609.4	661.9
2010/09/09	15:27:00	0.000	1441	1448	229.8	237.1	607.4	646.7
2010/09/09	15:28:00	0.000	1441	1447	229.8	235.3	600.0	660.5
2010/09/09	15:29:00	0.000	1443	1456	232.7	236.0	612.5	643.5
2010/09/09	15:30:00	0.000	1452	1461	233.9	237.9	602.1	632.6
2010/09/09	15:31:00	0.000	1424	1452	231.0	235.1	599.6	636.4
2010/09/09	15:32:00	0.000	1417	1424	230.4	236.8	601.2	638.5
2010/09/09	15:33:00	0.000	1417	1428	229.2	234.2	598.9	641.1
2010/09/09	15:34:00	0.000	1428	1432	229.8	234.8	616.5	641.1
2010/09/09	15:35:00	0.000	1432	1440	230.1	234.8	604.1	644.1
2010/09/09	15:36:00	0.000	1440	1446	230.7	234.5	593.9	640.5
2010/09/09	15:37:00	0.000	1436	1444	231.7	249.5	590.4	652.3
2010/09/09	15:38:00	0.000	1436	1471	249.5	270.1	626.7	657.9
2010/09/09	15:39:00	0.000	1465	1480	228.6	267.3	611.8	661.1
2010/09/09	15:40:00	0.000	1427	1465	227.1	230.7	619.1	658.4
2010/09/09	15:41:00	0.000	1411	1427	228.6	230.7	607.4	648.8
2010/09/09	15:42:00	0.000	1410	1415	229.2	232.2	593.3	640.8
2010/09/09	15:43:00	0.000	1415	1422	229.1	232.2	599.2	632.7
2010/09/09	15:44:00	0.000	1422	1431	227.7	233.0	596.0	637.5
2010/09/09	15:45:00	0.000	1431	1444	227.1	230.4	591.8	636.7
2010/09/09	15:46:00	0.000	1381	1460	226.0	313.8	591.8	660.7
2010/09/09	15:47:00	0.000	1389	1514	237.1	268.9	618.8	667.9
2010/09/09	15:48:00	0.000	1434	1501	214.8	238.9	620.2	663.2
2010/09/09	15:49:00	0.000	1399	1434	213.7	217.2	596.2	629.1
2010/09/09	15:50:00	0.000	1346	1477	214.2	308.5	611.4	651.4
2010/09/09	15:51:00	0.000	1477	1500	231.0	238.8	615.6	649.5
2010/09/09	15:52:00	0.000	1444	1482	229.5	233.0	616.7	658.5
2010/09/09	15:53:00	0.000	1425	1444	231.0	235.1	605.3	646.7
2010/09/09	15:54:00	0.000	1418	1425	231.0	235.1	605.3	641.7
2010/09/09	15:55:00	0.000	1412	1420	228.9	232.7	600.1	640.5
2010/09/09	15:56:00	0.000	1412	1422	228.9	233.4	600.1	646.1
2010/09/09	15:57:00	0.000	1422	1437	229.8	234.2	588.9	646.4
2010/09/09	15:58:00	0.000	1436	1439	228.0	236.2	610.0	639.1
2010/09/09	15:59:00	0.000	1436	1441	228.0	232.5	618.8	646.1
2010/09/09	16:00:00	0.000	1441	1443	228.6	234.2	607.0	658.7
2010/09/09	16:01:00	0.000	1442	1443	229.8	232.7	612.3	649.0
2010/09/09	16:02:00	0.000	1439	1450	230.9	309.1	614.1	658.4
2010/09/09	16:03:00	0.000	1378	1507	228.6	309.1	623.5	671.6
2010/09/09	16:04:00	0.000	1443	1501	226.0	229.2	623.9	656.2
2010/09/09	16:05:00	0.000	1418	1443	224.8	230.1	616.7	657.0
2010/09/09	16:06:00	0.000	1418	1420	226.0	230.7	615.0	655.8
2010/09/09	16:07:00	0.000	1416	1420	226.2	230.7	606.5	648.4
2010/09/09	16:08:00	0.000	1420	1431	225.3	229.5	609.1	648.4



2010/09/09	16:09:00	0.000	1383	1523	229.2	306.8	617.3	678.4
2010/09/09	16:10:00	0.000	1476	1527	226.0	233.8	603.9	656.4
2010/09/09	16:11:00	0.000	1422	1476	223.6	228.3	603.9	655.8
2010/09/09	16:12:00	0.000	1405	1422	223.6	226.5	595.6	642.0
2010/09/09	16:13:00	0.000	1404	1433	225.0	268.5	603.7	637.3
2010/09/09	16:14:00	0.000	1433	1504	234.2	272.4	610.3	654.3
2010/09/09	16:15:00	0.000	1460	1504	223.4	234.2	601.8	648.4
2010/09/09	16:16:00	0.000	1428	1460	223.6	226.9	613.5	654.0
2010/09/09	16:17:00	0.000	1406	1428	221.3	227.8	586.9	638.4
2010/09/09	16:18:00	0.000	1400	1409	222.7	227.4	598.0	636.4
2010/09/09	16:19:00	0.000	1348	1502	224.5	299.1	618.2	652.8
2010/09/09	16:20:00	0.000	1490	1525	227.1	252.4	607.6	657.0
2010/09/09	16:21:00	0.000	1430	1490	226.2	230.1	602.7	647.9
2010/09/09	16:22:00	0.000	1403	1430	225.7	229.2	614.6	653.5
2010/09/09	16:23:00	0.000	1399	1403	225.3	230.1	606.2	653.1
2010/09/09	16:24:00	0.000	1402	1409	226.9	228.3	614.4	643.5
2010/09/09	16:25:00	0.000	1409	1442	226.5	270.1	599.9	649.0
2010/09/09	16:26:00	0.000	1384	1532	236.9	298.2	628.5	668.1
2010/09/09	16:27:00	0.000	1489	1538	228.3	236.9	624.4	662.2
2010/09/09	16:28:00	0.000	1440	1489	227.1	230.7	613.9	652.8
2010/09/09	16:29:00	0.000	1418	1440	228.0	231.3	608.2	641.4
2010/09/09	16:30:00	0.000	1409	1418	229.5	233.1	611.8	648.1
2010/09/09	16:31:00	0.000	1406	1409	227.7	233.4	597.7	631.8
2010/09/09	16:32:00	0.000	1409	1414	227.1	229.5	597.4	629.7
2010/09/09	16:33:00	0.000	1414	1431	227.4	231.6	594.2	635.8
2010/09/09	16:34:00	0.000	1431	1455	226.9	279.7	593.6	660.2
2010/09/09	16:35:00	0.000	1455	1501	243.0	282.1	605.6	661.1
		<b>Average</b>	<b>1424</b>	<b>1452</b>	<b>229</b>	<b>248</b>		
		<b>Average</b>		<b>1438</b>		<b>239</b>		

Date	Time	Ch. Tag Unit sec	CH001		CH003		CH005		
			FLARE 1 TEMP		FLARE 1 FLOW		LFG FLOW		
			°F		SCFM		SCFM		
		MIN	MAX	MIN	MAX	MIN	MAX		
2010/09/09	18:50:00		0.000	1434	1438	232.7	237.7	596.8	612.3
2010/09/09	18:51:00		0.000	1435	1438	231.2	235.1	594.2	609.7
2010/09/09	18:52:00		0.000	1435	1438	232.1	236.5	589.8	618.2
2010/09/09	18:53:00		0.000	1434	1436	231.6	235.1	593.6	615.3
2010/09/09	18:54:00		0.000	1434	1439	231.8	234.4	584.8	613.9
2010/09/09	18:55:00		0.000	1437	1439	228.9	235.1	582.8	605.3
2010/09/09	18:56:00		0.000	1437	1438	231.0	235.3	591.5	605.3
2010/09/09	18:57:00		0.000	1437	1438	232.1	235.3	593.6	603.0
2010/09/09	18:58:00		0.000	1436	1438	230.7	234.8	585.4	607.3
2010/09/09	18:59:00		0.000	1436	1443	231.8	254.4	593.3	612.7
2010/09/09	19:00:00		0.000	1443	1461	248.6	253.2	595.7	615.8
2010/09/09	19:01:00		0.000	1461	1463	248.6	254.1	602.7	620.5
2010/09/09	19:02:00		0.000	1426	1461	209.8	254.4	591.8	617.9
2010/09/09	19:03:00		0.000	1389	1426	208.9	219.8	574.3	596.2
2010/09/09	19:04:00		0.000	1388	1418	219.8	232.5	576.9	588.7
2010/09/09	19:05:00		0.000	1418	1473	230.0	263.5	581.5	612.3
2010/09/09	19:06:00		0.000	1473	1500	246.0	268.6	610.0	631.1
2010/09/09	19:07:00		0.000	1433	1499	201.6	246.0	594.8	620.0
2010/09/09	19:08:00		0.000	1384	1433	201.2	235.3	581.6	613.0
2010/09/09	19:09:00		0.000	1385	1422	234.8	240.4	573.1	599.5
2010/09/09	19:10:00		0.000	1422	1449	234.8	238.8	584.8	599.7
2010/09/09	19:11:00		0.000	1446	1449	235.1	238.8	589.7	620.5
2010/09/09	19:12:00		0.000	1443	1446	235.3	238.8	596.5	618.5
2010/09/09	19:13:00		0.000	1439	1443	236.2	238.6	603.5	622.3
2010/09/09	19:14:00		0.000	1437	1440	236.8	243.0	591.3	618.2
2010/09/09	19:15:00		0.000	1437	1439	234.4	239.7	594.5	620.6
2010/09/09	19:16:00		0.000	1438	1439	234.4	239.7	596.2	611.2
2010/09/09	19:17:00		0.000	1437	1439	234.4	240.0	589.7	607.0
2010/09/09	19:18:00		0.000	1436	1439	234.7	238.8	586.6	613.2
2010/09/09	19:19:00		0.000	1433	1439	235.3	239.1	588.7	608.5
2010/09/09	19:20:00		0.000	1433	1435	232.5	237.9	592.3	613.0
2010/09/09	19:21:00		0.000	1433	1435	234.2	238.6	598.0	610.9
2010/09/09	19:22:00		0.000	1434	1436	234.4	239.4	595.1	612.3
2010/09/09	19:23:00		0.000	1435	1440	235.6	239.2	591.3	608.3
2010/09/09	19:24:00		0.000	1438	1439	235.6	238.8	582.7	602.1
2010/09/09	19:25:00		0.000	1438	1439	234.2	238.3	585.2	607.4
2010/09/09	19:26:00		0.000	1437	1439	233.9	237.4	578.0	604.1
2010/09/09	19:27:00		0.000	1435	1438	234.4	237.0	590.1	607.1
2010/09/09	19:28:00		0.000	1434	1437	234.7	237.9	584.4	606.5
2010/09/09	19:29:00		0.000	1437	1440	234.2	238.6	583.6	609.4
2010/09/09	19:30:00		0.000	1438	1440	233.6	237.7	583.3	593.6
2010/09/09	19:31:00		0.000	1438	1440	233.9	239.5	579.8	603.0
2010/09/09	19:32:00		0.000	1438	1440	233.3	239.5	583.6	603.0
2010/09/09	19:33:00		0.000	1439	1441	234.2	236.2	577.8	605.8
2010/09/09	19:34:00		0.000	1440	1442	231.2	235.9	586.2	613.2
2010/09/09	19:35:00		0.000	1437	1440	233.3	237.7	586.0	604.7
2010/09/09	19:36:00		0.000	1437	1438	232.5	237.7	589.2	602.3
2010/09/09	19:37:00		0.000	1436	1437	234.8	237.4	588.0	605.6

2010/09/09	19:38:00	0.000	1433	1436	233.9	237.7	585.7	609.4
2010/09/09	19:39:00	0.000	1434	1435	233.0	236.8	586.5	614.7
2010/09/09	19:40:00	0.000	1435	1438	233.0	236.0	593.0	614.4
2010/09/09	19:41:00	0.000	1437	1438	232.4	236.0	588.5	612.3
2010/09/09	19:42:00	0.000	1438	1440	233.3	237.9	586.8	609.4
2010/09/09	19:43:00	0.000	1439	1442	233.5	237.9	584.8	609.6
2010/09/09	19:44:00	0.000	1440	1441	233.0	235.9	584.9	607.9
2010/09/09	19:45:00	0.000	1439	1441	233.0	240.0	572.4	601.8
2010/09/09	19:46:00	0.000	1434	1439	232.7	236.5	579.2	601.1
2010/09/09	19:47:00	0.000	1432	1435	231.8	235.9	583.6	610.5
2010/09/09	19:48:00	0.000	1434	1436	231.2	235.9	583.0	602.7
2010/09/09	19:49:00	0.000	1435	1439	231.6	236.9	586.5	606.3
2010/09/09	19:50:00	0.000	1438	1439	232.4	239.7	573.4	593.0
2010/09/09	19:51:00	0.000	1439	1439	231.8	236.2	570.1	595.1
2010/09/09	19:52:00	0.000	1439	1440	231.8	236.5	573.6	595.1
2010/09/09	19:53:00	0.000	1437	1439	232.4	236.2	569.9	590.1
2010/09/09	19:54:00	0.000	1437	1438	230.3	235.9	574.4	589.2
2010/09/09	19:55:00	0.000	1435	1438	232.5	236.2	574.2	603.0
2010/09/09	19:56:00	0.000	1436	1437	231.2	234.4	576.9	597.7
2010/09/09	19:57:00	0.000	1436	1438	231.8	236.5	571.0	590.6
2010/09/09	19:58:00	0.000	1434	1437	232.4	236.2	569.8	589.7
2010/09/09	19:59:00	0.000	1435	1439	232.4	237.0	563.9	584.4
2010/09/09	20:00:00	0.000	1437	1439	231.6	236.5	561.4	578.3
2010/09/09	20:01:00	0.000	1436	1437	231.6	236.5	558.3	580.7
2010/09/09	20:02:00	0.000	1435	1436	230.9	234.4	567.4	587.8
2010/09/09	20:03:00	0.000	1436	1438	230.7	236.2	569.8	589.7
2010/09/09	20:04:00	0.000	1438	1439	230.9	234.7	569.9	588.8
2010/09/09	20:05:00	0.000	1435	1439	231.8	236.5	570.6	588.8
2010/09/09	20:06:00	0.000	1435	1438	231.2	235.9	564.2	590.4
2010/09/09	20:07:00	0.000	1438	1441	232.1	236.0	564.8	580.1
2010/09/09	20:08:00	0.000	1440	1442	232.1	235.6	567.8	590.4
2010/09/09	20:09:00	0.000	1436	1441	231.6	236.5	560.9	582.5
2010/09/09	20:10:00	0.000	1436	1437	230.7	234.7	563.9	591.8
2010/09/09	20:11:00	0.000	1436	1440	232.7	235.6	574.4	593.3
2010/09/09	20:12:00	0.000	1440	1442	231.8	234.7	573.0	592.7
2010/09/09	20:13:00	0.000	1439	1442	232.4	235.6	571.6	598.0
2010/09/09	20:14:00	0.000	1439	1440	231.8	236.3	572.7	598.0
2010/09/09	20:15:00	0.000	1437	1440	230.9	235.0	567.4	589.4
2010/09/09	20:16:00	0.000	1437	1438	230.9	235.6	568.1	589.4
2010/09/09	20:17:00	0.000	1436	1438	229.8	236.2	566.3	597.4
2010/09/09	20:18:00	0.000	1436	1438	230.9	235.1	573.1	587.1
2010/09/09	20:19:00	0.000	1438	1440	231.8	251.5	576.5	602.3
2010/09/09	20:20:00	0.000	1440	1460	249.5	253.5	578.7	602.1
2010/09/09	20:21:00	0.000	1460	1463	247.9	254.4	588.3	600.3
2010/09/09	20:22:00	0.000	1446	1460	225.1	253.5	586.5	603.0
2010/09/09	20:23:00	0.000	1411	1446	223.0	226.5	577.2	603.6
2010/09/09	20:24:00	0.000	1403	1411	223.0	227.7	568.1	587.1
2010/09/09	20:25:00	0.000	1404	1416	223.0	226.8	555.1	570.1
2010/09/09	20:26:00	0.000	1416	1432	221.8	254.4	546.9	570.4
2010/09/09	20:27:00	0.000	1432	1490	254.4	268.8	564.3	600.1
2010/09/09	20:28:00	0.000	1481	1504	230.0	266.7	586.9	603.9
2010/09/09	20:29:00	0.000	1431	1481	228.3	233.0	573.6	594.2

2010/09/09	20:30:00	0.000	1413	1431	229.5	233.5	563.6	594.5
2010/09/09	20:31:00	0.000	1410	1413	228.0	232.4	566.5	588.0
2010/09/09	20:32:00	0.000	1411	1419	228.6	232.8	558.4	579.5
2010/09/09	20:33:00	0.000	1419	1427	227.7	232.8	563.1	583.4
2010/09/09	20:34:00	0.000	1427	1440	229.1	232.1	557.2	575.1
2010/09/09	20:35:00	0.000	1440	1441	227.1	230.7	562.1	579.2
2010/09/09	20:36:00	0.000	1438	1441	226.9	230.7	559.5	580.4
2010/09/09	20:37:00	0.000	1438	1448	227.1	249.7	570.4	594.2
2010/09/09	20:38:00	0.000	1448	1464	247.7	252.7	581.6	607.0
2010/09/09	20:39:00	0.000	1460	1464	247.9	256.1	589.5	607.6
2010/09/09	20:40:00	0.000	1430	1460	204.5	256.1	562.2	611.4
2010/09/09	20:41:00	0.000	1391	1430	202.4	233.0	555.5	577.1
2010/09/09	20:42:00	0.000	1391	1441	233.0	259.4	561.3	587.7
2010/09/09	20:43:00	0.000	1441	1476	255.0	259.1	569.8	598.6
2010/09/09	20:44:00	0.000	1455	1480	229.5	255.0	572.5	600.3
2010/09/09	20:45:00	0.000	1419	1455	229.1	234.4	574.0	589.2
2010/09/09	20:46:00	0.000	1412	1419	230.4	233.9	561.8	587.9
2010/09/09	20:47:00	0.000	1414	1420	228.9	232.5	563.4	573.0
2010/09/09	20:48:00	0.000	1419	1430	228.6	231.5	558.8	576.8
2010/09/09	20:49:00	0.000	1430	1439	228.0	231.8	559.2	572.7
2010/09/09	20:50:00	0.000	1436	1439	228.6	233.9	553.7	575.3
2010/09/09	20:51:00	0.000	1437	1440	228.9	233.9	565.2	583.9
2010/09/09	20:52:00	0.000	1438	1440	227.4	230.7	566.0	587.9
2010/09/09	20:53:00	0.000	1438	1441	228.0	233.2	566.0	584.1
2010/09/09	20:54:00	0.000	1440	1457	233.2	252.6	576.2	587.9
2010/09/09	20:55:00	0.000	1457	1463	246.8	251.2	567.9	601.8
		<b>Average</b>	<b>1433</b>	<b>1443</b>	<b>232</b>	<b>239</b>		
		<b>Average</b>		<b>1438</b>		<b>235</b>		

Date	Time	Ch. Tag Unit sec	CH001 FLARE 1 TEMP °F		CH003 FLARE 1 FLOW SCFM		CH005 LFG FLOW SCFM	
			MIN	MAX	MIN	MAX	MIN	MAX
2010/09/10	15:25:00	0.000	1432	1441	223.4	225.7	622.9	642.9
2010/09/10	15:26:00	0.000	1441	1444	223.1	225.2	622.4	654.4
2010/09/10	15:27:00	0.000	1443	1446	223.4	227.4	628.6	649.6
2010/09/10	15:28:00	0.000	1444	1447	223.9	227.4	627.1	655.0
2010/09/10	15:29:00	0.000	1442	1450	223.7	227.1	636.3	658.5
2010/09/10	15:30:00	0.000	1449	1456	223.6	228.0	618.0	650.0
2010/09/10	15:31:00	0.000	1433	1449	223.9	228.0	618.0	641.8
2010/09/10	15:32:00	0.000	1423	1433	223.5	225.1	621.2	639.1
2010/09/10	15:33:00	0.000	1423	1425	222.5	227.5	616.3	638.9
2010/09/10	15:34:00	0.000	1423	1429	222.5	227.5	614.5	636.4
2010/09/10	15:35:00	0.000	1429	1435	222.5	225.4	616.6	639.1
2010/09/10	15:36:00	0.000	1433	1444	221.8	225.7	620.3	635.4
2010/09/10	15:37:00	0.000	1444	1450	222.7	225.1	620.0	638.8
2010/09/10	15:38:00	0.000	1449	1451	222.7	226.0	623.4	642.4
2010/09/10	15:39:00	0.000	1431	1451	222.5	226.5	616.7	643.5
2010/09/10	15:40:00	0.000	1429	1432	223.6	228.0	625.0	651.1
2010/09/10	15:41:00	0.000	1432	1437	224.5	227.1	631.8	653.5
2010/09/10	15:42:00	0.000	1431	1439	223.6	226.6	635.6	652.5
2010/09/10	15:43:00	0.000	1435	1439	224.0	227.5	619.5	651.7
2010/09/10	15:44:00	0.000	1433	1437	223.6	227.8	612.7	641.3
2010/09/10	15:45:00	0.000	1437	1440	222.5	226.0	608.3	632.9
2010/09/10	15:46:00	0.000	1440	1452	222.5	225.7	614.5	625.4
2010/09/10	15:47:00	0.000	1445	1457	222.5	226.3	612.7	629.3
2010/09/10	15:48:00	0.000	1430	1445	223.1	225.7	602.4	623.2
2010/09/10	15:49:00	0.000	1430	1445	222.2	225.7	614.2	634.1
2010/09/10	15:50:00	0.000	1445	1452	223.1	225.7	616.5	635.0
2010/09/10	15:51:00	0.000	1437	1451	223.9	226.3	616.3	636.2
2010/09/10	15:52:00	0.000	1437	1439	223.4	226.0	622.7	643.8
2010/09/10	15:53:00	0.000	1432	1438	223.4	226.6	616.6	636.4
2010/09/10	15:54:00	0.000	1425	1432	223.4	226.0	616.2	638.9
2010/09/10	15:55:00	0.000	1429	1437	221.9	226.0	616.5	647.8
2010/09/10	15:56:00	0.000	1429	1438	223.6	227.4	617.4	637.3
2010/09/10	15:57:00	0.000	1427	1436	222.7	225.7	621.6	636.2
2010/09/10	15:58:00	0.000	1435	1439	223.1	226.0	611.2	631.5
2010/09/10	15:59:00	0.000	1437	1447	222.7	225.7	614.8	640.0
2010/09/10	16:00:00	0.000	1436	1447	224.3	226.9	613.6	635.8
2010/09/10	16:01:00	0.000	1424	1436	222.5	226.6	611.8	630.9
2010/09/10	16:02:00	0.000	1424	1431	221.9	225.2	614.4	642.7
2010/09/10	16:03:00	0.000	1429	1434	223.6	225.4	624.1	644.4
2010/09/10	16:04:00	0.000	1434	1436	222.8	226.6	620.6	637.6
2010/09/10	16:05:00	0.000	1435	1437	223.1	225.7	616.8	635.2
2010/09/10	16:06:00	0.000	1434	1436	222.2	225.3	622.0	642.0
2010/09/10	16:07:00	0.000	1434	1440	223.4	226.0	619.6	651.1
2010/09/10	16:08:00	0.000	1440	1450	223.4	226.0	624.1	645.7
2010/09/10	16:09:00	0.000	1450	1455	223.4	226.6	623.8	644.4
2010/09/10	16:10:00	0.000	1449	1453	223.6	227.8	625.6	647.2
2010/09/10	16:11:00	0.000	1429	1449	222.7	227.4	617.4	633.4
2010/09/10	16:12:00	0.000	1423	1429	222.5	225.7	621.5	636.7

2010/09/10	16:13:00	0.000	1425	1440	224.3	226.6	620.1	637.1
2010/09/10	16:14:00	0.000	1431	1440	223.9	228.0	619.4	637.5
2010/09/10	16:15:00	0.000	1432	1436	223.9	226.6	615.9	637.5
2010/09/10	16:16:00	0.000	1435	1441	223.1	226.6	619.2	634.7
2010/09/10	16:17:00	0.000	1430	1439	223.1	226.6	619.2	632.0
2010/09/10	16:18:00	0.000	1430	1436	223.0	225.4	619.3	637.3
2010/09/10	16:19:00	0.000	1436	1446	224.3	226.6	618.5	638.4
2010/09/10	16:20:00	0.000	1439	1442	224.5	226.9	620.1	643.8
2010/09/10	16:21:00	0.000	1434	1442	223.6	227.4	622.3	639.1
2010/09/10	16:22:00	0.000	1432	1435	223.6	225.7	623.2	639.1
2010/09/10	16:23:00	0.000	1435	1443	223.6	226.9	627.6	640.0
2010/09/10	16:24:00	0.000	1436	1444	224.5	227.8	621.8	645.0
2010/09/10	16:25:00	0.000	1435	1436	224.1	227.8	618.0	647.8
2010/09/10	16:26:00	0.000	1434	1436	223.1	227.8	617.5	638.5
2010/09/10	16:27:00	0.000	1436	1438	224.0	227.1	615.6	636.7
2010/09/10	16:28:00	0.000	1436	1439	223.1	227.1	613.3	633.8
2010/09/10	16:29:00	0.000	1434	1439	224.3	228.3	610.3	629.4
2010/09/10	16:30:00	0.000	1434	1438	224.3	228.3	607.4	624.5
2010/09/10	16:31:00	0.000	1438	1441	222.7	226.6	608.3	627.1
2010/09/10	16:32:00	0.000	1441	1448	222.7	226.6	605.0	628.5
2010/09/10	16:33:00	0.000	1447	1449	223.9	226.9	612.4	628.5
2010/09/10	16:34:00	0.000	1449	1458	224.3	226.6	608.9	630.1
2010/09/10	16:35:00	0.000	1441	1456	224.3	227.8	611.2	637.4
2010/09/10	16:36:00	0.000	1421	1441	224.3	228.1	606.3	628.3
2010/09/10	16:37:00	0.000	1420	1426	223.6	228.7	616.3	645.5
2010/09/10	16:38:00	0.000	1426	1435	225.1	227.8	626.2	644.1
2010/09/10	16:39:00	0.000	1435	1451	225.0	229.2	621.8	645.5
2010/09/10	16:40:00	0.000	1438	1450	226.0	228.6	616.5	642.1
2010/09/10	16:41:00	0.000	1427	1438	224.5	228.3	617.0	638.8
2010/09/10	16:42:00	0.000	1424	1427	226.0	228.6	622.4	651.7
2010/09/10	16:43:00	0.000	1427	1435	225.4	228.9	612.8	645.0
2010/09/10	16:44:00	0.000	1435	1441	225.4	228.9	612.1	637.3
2010/09/10	16:45:00	0.000	1441	1460	225.4	228.9	613.9	624.7
2010/09/10	16:46:00	0.000	1446	1460	224.3	229.6	607.7	624.1
2010/09/10	16:47:00	0.000	1442	1449	225.4	229.2	605.0	626.7
2010/09/10	16:48:00	0.000	1430	1442	223.6	227.4	608.0	627.2
2010/09/10	16:49:00	0.000	1429	1439	224.6	226.6	597.7	618.8
2010/09/10	16:50:00	0.000	1439	1441	224.3	226.3	608.0	638.8
2010/09/10	16:51:00	0.000	1436	1443	224.5	227.1	604.1	630.1
2010/09/10	16:52:00	0.000	1436	1442	225.3	228.0	609.2	628.3
2010/09/10	16:53:00	0.000	1441	1444	224.8	228.6	612.1	628.3
2010/09/10	16:54:00	0.000	1424	1441	224.5	228.3	608.5	629.7
2010/09/10	16:55:00	0.000	1423	1424	225.4	228.7	607.6	629.2
2010/09/10	16:56:00	0.000	1424	1432	223.1	227.1	601.7	622.4
2010/09/10	16:57:00	0.000	1432	1449	223.4	227.4	603.6	626.5
2010/09/10	16:58:00	0.000	1439	1451	223.4	229.5	595.4	618.3
2010/09/10	16:59:00	0.000	1433	1439	223.6	227.1	595.4	626.7
2010/09/10	17:00:00	0.000	1433	1438	222.7	226.2	603.0	624.7
2010/09/10	17:01:00	0.000	1429	1433	223.1	226.0	601.2	624.1
2010/09/10	17:02:00	0.000	1429	1433	223.1	226.0	598.4	626.5
2010/09/10	17:03:00	0.000	1432	1434	223.4	226.9	602.4	625.3
2010/09/10	17:04:00	0.000	1434	1440	223.4	224.8	605.7	624.4

2010/09/10	17:05:00	0.000	1440	1443	221.9	226.2	603.9	631.9
2010/09/10	17:06:00	0.000	1441	1443	224.3	226.0	610.2	633.8
2010/09/10	17:07:00	0.000	1437	1443	224.3	226.5	596.3	624.0
2010/09/10	17:08:00	0.000	1437	1439	223.4	227.4	607.6	622.9
2010/09/10	17:09:00	0.000	1438	1439	223.1	227.5	608.2	625.6
2010/09/10	17:10:00	0.000	1437	1441	223.6	225.7	602.5	629.7
2010/09/10	17:11:00	0.000	1436	1437	223.9	226.0	605.0	617.9
2010/09/10	17:12:00	0.000	1436	1446	223.1	226.9	601.8	627.1
2010/09/10	17:13:00	0.000	1442	1448	224.5	226.2	610.3	627.4
2010/09/10	17:14:00	0.000	1431	1442	223.4	226.0	609.4	627.1
2010/09/10	17:15:00	0.000	1431	1433	223.6	227.1	605.7	640.9
2010/09/10	17:16:00	0.000	1431	1436	223.4	227.1	595.7	625.8
2010/09/10	17:17:00	0.000	1435	1437	223.3	226.9	597.5	620.1
2010/09/10	17:18:00	0.000	1437	1439	223.0	226.2	597.5	627.4
2010/09/10	17:19:00	0.000	1435	1437	221.2	225.9	581.0	618.0
2010/09/10	17:20:00	0.000	1433	1436	221.2	225.1	581.0	622.1
2010/09/10	17:21:00	0.000	1434	1445	223.6	228.9	601.5	622.9
2010/09/10	17:22:00	0.000	1444	1450	223.0	227.4	598.6	619.7
2010/09/10	17:23:00	0.000	1435	1444	222.2	225.4	587.5	617.7
2010/09/10	17:24:00	0.000	1436	1439	222.2	225.3	587.5	615.3
2010/09/10	17:25:00	0.000	1437	1444	222.5	225.4	588.0	614.1
2010/09/10	17:26:00	0.000	1434	1444	221.8	224.8	586.4	617.1
2010/09/10	17:27:00	0.000	1432	1434	221.0	224.8	586.4	619.2
2010/09/10	17:28:00	0.000	1434	1436	222.5	226.0	594.7	618.0
2010/09/10	17:29:00	0.000	1436	1438	223.0	226.0	596.0	628.3
2010/09/10	17:30:00	0.000	1435	1447	223.4	226.4	600.1	630.2
		<b>Average</b>	<b>1434</b>	<b>1441</b>	<b>223</b>	<b>227</b>		
				<b>1438</b>		<b>225</b>		

Date	Time	Ch. Tag Unit sec	CH001 FLARE 1 TEMP °F			CH003 FLARE 1 FLOW SCFM			CH005 LFG FLOW SCFM		
			MIN	MAX		MIN	MAX		MIN	MAX	
2010/09/10	19:50:00		0.000	1460	1498	270.6	275.1		619.8	638.1	
2010/09/10	19:51:00		0.000	1483	1501	250.0	275.7		629.4	643.2	
2010/09/10	19:52:00		0.000	1450	1483	248.0	253.0		621.5	634.7	
2010/09/10	19:53:00		0.000	1430	1450	249.2	253.6		610.9	635.5	
2010/09/10	19:54:00		0.000	1423	1430	247.4	253.2		606.5	618.6	
2010/09/10	19:55:00		0.000	1420	1423	247.1	251.5		598.7	623.3	
2010/09/10	19:56:00		0.000	1421	1423	247.4	252.1		605.4	623.2	
2010/09/10	19:57:00		0.000	1423	1429	247.1	251.3		601.3	618.9	
2010/09/10	19:58:00		0.000	1429	1431	247.7	250.9		604.9	624.0	
2010/09/10	19:59:00		0.000	1431	1438	248.6	252.2		611.8	622.4	
2010/09/10	20:00:00		0.000	1438	1442	245.6	253.1		608.3	628.0	
2010/09/10	20:01:00		0.000	1440	1442	248.6	253.6		607.7	621.8	
2010/09/10	20:02:00		0.000	1439	1440	247.4	251.3		605.1	620.3	
2010/09/10	20:03:00		0.000	1439	1440	249.5	252.7		597.1	618.3	
2010/09/10	20:04:00		0.000	1438	1439	248.0	254.4		603.6	617.1	
2010/09/10	20:05:00		0.000	1436	1438	246.9	252.4		593.6	615.6	
2010/09/10	20:06:00		0.000	1435	1436	247.1	251.5		592.7	617.6	
2010/09/10	20:07:00		0.000	1435	1437	246.5	251.8		596.0	615.3	
2010/09/10	20:08:00		0.000	1437	1444	245.3	250.4		590.4	608.5	
2010/09/10	20:09:00		0.000	1443	1446	248.0	251.5		586.6	604.0	
2010/09/10	20:10:00		0.000	1441	1443	247.7	251.5		592.9	615.4	
2010/09/10	20:11:00		0.000	1439	1442	246.8	250.4		596.6	618.5	
2010/09/10	20:12:00		0.000	1435	1439	247.7	251.8		596.6	619.1	
2010/09/10	20:13:00		0.000	1433	1435	247.9	253.2		603.0	620.6	
2010/09/10	20:14:00		0.000	1432	1434	246.5	250.9		589.6	619.7	
2010/09/10	20:15:00		0.000	1432	1434	246.2	251.5		604.9	619.7	
2010/09/10	20:16:00		0.000	1434	1439	247.1	253.2		600.4	617.4	
2010/09/10	20:17:00		0.000	1438	1439	247.1	253.2		593.6	623.2	
2010/09/10	20:18:00		0.000	1437	1438	247.4	252.1		585.4	618.5	
2010/09/10	20:19:00		0.000	1437	1438	246.8	250.4		592.3	613.0	
2010/09/10	20:20:00		0.000	1437	1439	247.7	251.3		594.5	618.3	
2010/09/10	20:21:00		0.000	1439	1441	244.4	249.5		595.4	609.2	
2010/09/10	20:22:00		0.000	1439	1441	245.1	252.1		599.2	616.6	
2010/09/10	20:23:00		0.000	1436	1442	246.5	252.1		598.0	613.9	
2010/09/10	20:24:00		0.000	1436	1440	246.2	252.4		598.0	607.4	
2010/09/10	20:25:00		0.000	1437	1440	246.2	248.8		584.3	608.3	
2010/09/10	20:26:00		0.000	1433	1437	246.2	248.8		600.3	611.5	
2010/09/10	20:27:00		0.000	1434	1435	246.2	253.9		601.5	617.4	
2010/09/10	20:28:00		0.000	1434	1436	247.7	253.2		599.8	620.9	
2010/09/10	20:29:00		0.000	1435	1437	247.7	255.9		601.8	625.8	
2010/09/10	20:30:00		0.000	1435	1442	248.0	254.1		601.8	614.1	
2010/09/10	20:31:00		0.000	1440	1442	247.4	252.7		586.6	616.7	
2010/09/10	20:32:00		0.000	1439	1441	247.7	252.1		589.2	613.0	
2010/09/10	20:33:00		0.000	1435	1439	244.8	250.0		582.5	600.6	
2010/09/10	20:34:00		0.000	1432	1435	246.5	250.0		584.5	610.1	
2010/09/10	20:35:00		0.000	1432	1434	244.8	249.5		590.9	615.6	
2010/09/10	20:36:00		0.000	1433	1438	244.8	251.2		588.7	609.3	
2010/09/10	20:37:00		0.000	1438	1442	247.4	250.9		588.7	613.6	
2010/09/10	20:38:00		0.000	1442	1443	247.4	252.4		587.5	613.6	
2010/09/10	20:39:00		0.000	1442	1444	247.4	255.0		583.9	603.6	
2010/09/10	20:40:00		0.000	1438	1442	246.0	251.5		582.1	599.2	
2010/09/10	20:41:00		0.000	1433	1438	245.1	250.0		587.8	605.7	



2010/09/10	20:42:00	0.000	1433	1437	243.8	249.1	588.9	610.0
2010/09/10	20:43:00	0.000	1436	1437	245.6	249.1	590.2	611.5
2010/09/10	20:44:00	0.000	1436	1438	244.4	270.1	587.8	605.3
2010/09/10	20:45:00	0.000	1438	1468	265.9	271.5	598.9	620.0
2010/09/10	20:46:00	0.000	1468	1485	266.6	271.0	607.1	622.7
2010/09/10	20:47:00	0.000	1454	1485	222.7	267.6	592.4	622.3
2010/09/10	20:48:00	0.000	1401	1454	223.3	234.8	579.8	600.4
2010/09/10	20:49:00	0.000	1393	1409	234.8	267.4	580.6	598.9
2010/09/10	20:50:00	0.000	1409	1463	262.4	268.5	588.7	603.6
2010/09/10	20:51:00	0.000	1463	1481	265.0	267.9	599.2	619.7
2010/09/10	20:52:00	0.000	1464	1481	243.0	268.5	593.3	625.8
2010/09/10	20:53:00	0.000	1430	1464	241.5	246.5	593.3	613.5
2010/09/10	20:54:00	0.000	1412	1430	240.6	246.5	586.2	613.9
2010/09/10	20:55:00	0.000	1408	1412	240.6	246.9	577.8	600.1
2010/09/10	20:56:00	0.000	1408	1411	239.7	246.9	577.8	604.8
2010/09/10	20:57:00	0.000	1411	1423	239.7	243.6	579.8	596.9
2010/09/10	20:58:00	0.000	1423	1435	239.7	250.0	584.5	599.8
2010/09/10	20:59:00	0.000	1435	1454	250.0	254.7	576.3	601.3
2010/09/10	21:00:00	0.000	1454	1456	250.0	254.1	583.4	613.4
2010/09/10	21:01:00	0.000	1452	1456	252.1	255.3	591.7	608.8
2010/09/10	21:02:00	0.000	1447	1452	250.9	253.5	592.2	608.8
2010/09/10	21:03:00	0.000	1442	1447	250.4	253.9	596.5	608.5
2010/09/10	21:04:00	0.000	1438	1442	250.9	256.8	594.3	608.8
2010/09/10	21:05:00	0.000	1435	1438	248.8	253.9	588.3	606.5
2010/09/10	21:06:00	0.000	1432	1435	248.6	253.8	583.4	600.4
2010/09/10	21:07:00	0.000	1432	1435	250.4	254.1	585.6	599.2
2010/09/10	21:08:00	0.000	1435	1436	250.4	255.6	581.8	599.2
2010/09/10	21:09:00	0.000	1435	1438	250.6	253.8	583.6	604.8
2010/09/10	21:10:00	0.000	1438	1439	249.7	255.0	599.8	608.5
2010/09/10	21:11:00	0.000	1438	1440	248.6	255.3	590.8	602.7
2010/09/10	21:12:00	0.000	1439	1441	251.2	258.6	590.6	608.3
2010/09/10	21:13:00	0.000	1439	1442	250.5	257.4	585.1	599.8
2010/09/10	21:14:00	0.000	1438	1440	250.3	257.4	581.3	603.2
2010/09/10	21:15:00	0.000	1440	1444	251.5	256.5	581.3	597.9
2010/09/10	21:16:00	0.000	1438	1442	251.2	257.4	583.9	594.1
2010/09/10	21:17:00	0.000	1438	1439	249.1	255.0	585.3	600.2
2010/09/10	21:18:00	0.000	1435	1439	237.4	255.6	588.6	598.0
2010/09/10	21:19:00	0.000	1404	1435	215.9	237.4	572.2	593.9
2010/09/10	21:20:00	0.000	1392	1409	215.6	261.8	563.3	588.3
2010/09/10	21:21:00	0.000	1409	1460	259.5	262.4	578.6	591.5
2010/09/10	21:22:00	0.000	1460	1473	257.7	263.0	585.7	609.5
2010/09/10	21:23:00	0.000	1471	1473	259.7	262.7	591.5	614.9
2010/09/10	21:24:00	0.000	1445	1471	212.5	265.9	587.2	615.6
2010/09/10	21:25:00	0.000	1386	1445	210.0	256.8	571.6	593.1
2010/09/10	21:26:00	0.000	1386	1424	255.8	259.7	571.3	601.5
2010/09/10	21:27:00	0.000	1424	1456	255.3	259.7	581.1	601.2
2010/09/10	21:28:00	0.000	1456	1459	255.0	259.7	579.2	601.5
2010/09/10	21:29:00	0.000	1452	1457	254.4	261.2	586.0	602.1
2010/09/10	21:30:00	0.000	1447	1452	256.2	261.5	573.2	602.1
2010/09/10	21:31:00	0.000	1442	1447	237.0	261.5	583.5	605.9
2010/09/10	21:32:00	0.000	1412	1442	233.9	237.1	578.2	595.0
2010/09/10	21:33:00	0.000	1400	1412	233.3	237.1	566.0	583.0
2010/09/10	21:34:00	0.000	1400	1403	232.1	259.7	563.0	580.1
2010/09/10	21:35:00	0.000	1403	1458	259.7	269.7	573.0	595.1
2010/09/10	21:36:00	0.000	1458	1487	265.0	268.8	576.8	604.1
2010/09/10	21:37:00	0.000	1487	1491	239.1	269.7	599.7	611.2

2010/09/10	21:38:00	0.000	1441	1487	235.1	241.2	583.0	607.9
2010/09/10	21:39:00	0.000	1408	1441	234.7	239.2	578.1	592.7
2010/09/10	21:40:00	0.000	1396	1408	235.6	239.2	574.2	593.6
2010/09/10	21:41:00	0.000	1396	1414	235.3	263.6	570.7	591.5
2010/09/10	21:42:00	0.000	1414	1470	262.7	267.1	581.8	602.7
2010/09/10	21:43:00	0.000	1470	1482	263.9	268.0	589.2	610.1
2010/09/10	21:44:00	0.000	1473	1481	244.8	265.3	589.8	610.0
2010/09/10	21:45:00	0.000	1440	1473	245.0	248.8	581.9	601.2
2010/09/10	21:46:00	0.000	1423	1440	243.9	247.8	572.7	595.1
2010/09/10	21:47:00	0.000	1418	1423	244.4	249.7	568.4	589.5
2010/09/10	21:48:00	0.000	1416	1418	244.2	249.5	566.5	587.7
2010/09/10	21:49:00	0.000	1418	1420	244.4	249.1	563.8	588.6
2010/09/10	21:50:00	0.000	1419	1426	247.4	250.5	566.3	586.2
2010/09/10	21:51:00	0.000	1426	1432	243.9	250.3	571.3	584.1
2010/09/10	21:52:00	0.000	1432	1439	243.9	248.6	568.7	583.6
2010/09/10	21:53:00	0.000	1438	1440	244.7	250.3	571.4	588.6
2010/09/10	21:54:00	0.000	1439	1441	245.3	249.1	571.6	598.6
2010/09/10	21:55:00	0.000	1441	1443	245.1	248.8	568.6	591.8
<b>Average</b>			<b>1433</b>	<b>1444</b>	<b>246</b>	<b>254</b>		
				<b>1439</b>		<b>250</b>		

Date	Time	Ch. Tag Unit sec	CH001 FLARE 1 TEMP °F		CH003 FLARE 1 FLOW SCFM		CH005 LFG FLOW SCFM		
			MIN	MAX	MIN	MAX	MIN	MAX	
2010/09/11	10:30:00		0.000	1438	1439	246.8	251.3	279.3	297.2
2010/09/11	10:31:00		0.000	1437	1439	246.5	250.6	281.3	291.6
2010/09/11	10:32:00		0.000	1439	1443	247.7	252.4	280.2	289.5
2010/09/11	10:33:00		0.000	1435	1440	247.9	251.8	284.6	293.7
2010/09/11	10:34:00		0.000	1435	1436	247.7	251.5	278.1	300.7
2010/09/11	10:35:00		0.000	1436	1439	246.9	251.8	283.9	300.7
2010/09/11	10:36:00		0.000	1437	1439	246.0	249.7	281.6	295.1
2010/09/11	10:37:00		0.000	1439	1442	245.1	250.4	282.1	297.7
2010/09/11	10:38:00		0.000	1441	1445	248.4	251.3	275.4	295.4
2010/09/11	10:39:00		0.000	1434	1444	247.1	251.8	282.5	293.0
2010/09/11	10:40:00		0.000	1434	1437	247.9	252.1	280.4	293.7
2010/09/11	10:41:00		0.000	1437	1438	246.2	250.4	283.7	295.6
2010/09/11	10:42:00		0.000	1438	1441	246.9	250.9	279.5	296.9
2010/09/11	10:43:00		0.000	1436	1441	246.9	252.1	279.6	294.5
2010/09/11	10:44:00		0.000	1434	1436	248.0	251.5	276.8	297.7
2010/09/11	10:45:00		0.000	1432	1435	246.2	251.5	280.7	294.7
2010/09/11	10:46:00		0.000	1431	1435	247.7	251.2	281.0	294.5
2010/09/11	10:47:00		0.000	1435	1443	246.0	252.2	278.5	292.8
2010/09/11	10:48:00		0.000	1441	1443	246.9	253.2	279.8	292.4
2010/09/11	10:49:00		0.000	1440	1441	248.0	249.5	275.7	294.7
2010/09/11	10:50:00		0.000	1440	1444	246.2	252.4	277.7	291.9
2010/09/11	10:51:00		0.000	1439	1446	248.6	252.3	279.3	295.4
2010/09/11	10:52:00		0.000	1428	1439	247.9	250.6	281.9	292.3
2010/09/11	10:53:00		0.000	1428	1433	246.5	251.8	278.1	298.0
2010/09/11	10:54:00		0.000	1433	1437	247.1	249.8	274.4	290.9
2010/09/11	10:55:00		0.000	1436	1440	247.1	253.5	280.8	293.9
2010/09/11	10:56:00		0.000	1439	1440	247.1	251.3	282.8	294.2
2010/09/11	10:57:00		0.000	1437	1439	244.8	251.5	283.7	297.2
2010/09/11	10:58:00		0.000	1438	1447	247.4	252.2	274.2	292.5
2010/09/11	10:59:00		0.000	1439	1445	246.8	252.7	281.6	298.0
2010/09/11	11:00:00		0.000	1436	1439	248.3	252.4	280.7	298.9
2010/09/11	11:01:00		0.000	1437	1441	247.1	253.6	278.9	300.9
2010/09/11	11:02:00		0.000	1439	1440	247.1	251.5	281.9	295.1
2010/09/11	11:03:00		0.000	1439	1439	247.1	250.9	283.4	293.0
2010/09/11	11:04:00		0.000	1439	1440	248.9	251.8	285.6	295.1
2010/09/11	11:05:00		0.000	1438	1440	246.5	253.9	284.6	294.8
2010/09/11	11:06:00		0.000	1436	1439	248.8	253.9	277.5	297.7
2010/09/11	11:07:00		0.000	1433	1436	247.7	252.4	283.0	296.3
2010/09/11	11:08:00		0.000	1434	1435	247.3	252.2	281.0	296.8
2010/09/11	11:09:00		0.000	1434	1438	248.3	253.6	281.9	299.5
2010/09/11	11:10:00		0.000	1438	1440	248.8	253.6	279.6	296.4
2010/09/11	11:11:00		0.000	1435	1439	248.6	252.2	282.8	294.8
2010/09/11	11:12:00		0.000	1436	1444	247.1	251.8	282.5	301.4
2010/09/11	11:13:00		0.000	1440	1444	248.0	252.1	281.1	294.2
2010/09/11	11:14:00		0.000	1435	1440	247.1	251.5	282.8	295.4
2010/09/11	11:15:00		0.000	1436	1439	247.1	251.5	283.7	298.0
2010/09/11	11:16:00		0.000	1438	1439	248.3	252.4	287.0	299.2
2010/09/11	11:17:00		0.000	1438	1438	248.3	254.1	286.9	299.9
2010/09/11	11:18:00		0.000	1435	1438	248.6	252.1	280.3	300.4
2010/09/11	11:19:00		0.000	1434	1436	248.0	253.5	287.4	300.4
2010/09/11	11:20:00		0.000	1436	1438	248.6	252.7	282.2	297.7
2010/09/11	11:21:00		0.000	1437	1439	249.5	253.9	282.2	295.6

2010/09/11	11:22:00	0.000	1439	1441	248.0	251.5	283.9	296.3
2010/09/11	11:23:00	0.000	1437	1440	247.4	253.0	283.0	294.9
2010/09/11	11:24:00	0.000	1437	1441	248.3	254.4	281.1	293.9
2010/09/11	11:25:00	0.000	1441	1448	248.9	252.4	280.9	296.8
2010/09/11	11:26:00	0.000	1435	1444	247.4	253.0	284.5	296.0
2010/09/11	11:27:00	0.000	1434	1439	249.5	254.8	284.5	295.2
2010/09/11	11:28:00	0.000	1434	1439	248.8	253.0	280.6	294.4
2010/09/11	11:29:00	0.000	1435	1439	248.6	252.4	283.7	295.6
2010/09/11	11:30:00	0.000	1435	1438	248.1	253.2	283.7	294.7
2010/09/11	11:31:00	0.000	1435	1439	249.5	252.7	280.5	296.9
2010/09/11	11:32:00	0.000	1435	1441	248.8	252.7	285.9	300.0
2010/09/11	11:33:00	0.000	1438	1441	248.8	252.4	282.8	300.0
2010/09/11	11:34:00	0.000	1438	1441	249.2	254.1	280.7	294.2
2010/09/11	11:35:00	0.000	1438	1440	248.3	253.0	285.5	300.1
2010/09/11	11:36:00	0.000	1439	1443	248.3	251.8	285.4	296.3
2010/09/11	11:37:00	0.000	1436	1441	248.6	252.2	282.8	298.6
2010/09/11	11:38:00	0.000	1432	1436	247.1	253.0	283.7	298.1
2010/09/11	11:39:00	0.000	1434	1434	249.2	253.2	285.4	300.8
2010/09/11	11:40:00	0.000	1434	1441	248.6	252.7	283.7	298.9
2010/09/11	11:41:00	0.000	1440	1442	248.6	252.2	285.5	298.6
2010/09/11	11:42:00	0.000	1442	1443	248.6	253.6	281.3	295.4
2010/09/11	11:43:00	0.000	1434	1442	247.7	253.0	283.9	292.9
2010/09/11	11:44:00	0.000	1434	1436	247.7	254.4	274.8	299.2
2010/09/11	11:45:00	0.000	1434	1436	248.9	252.4	283.8	294.6
2010/09/11	11:46:00	0.000	1432	1434	249.5	253.2	285.1	304.5
2010/09/11	11:47:00	0.000	1433	1440	249.2	255.0	283.0	293.0
2010/09/11	11:48:00	0.000	1440	1442	248.9	253.6	285.7	297.9
2010/09/11	11:49:00	0.000	1441	1444	248.6	251.8	285.4	298.3
2010/09/11	11:50:00	0.000	1438	1443	248.6	252.1	281.9	297.4
2010/09/11	11:51:00	0.000	1439	1441	249.4	252.7	286.3	298.6
2010/09/11	11:52:00	0.000	1434	1439	250.1	254.4	284.2	296.9
2010/09/11	11:53:00	0.000	1435	1442	249.2	253.6	285.5	300.4
2010/09/11	11:54:00	0.000	1440	1442	250.1	253.6	285.1	300.4
2010/09/11	11:55:00	0.000	1439	1440	250.9	254.8	286.0	298.7
2010/09/11	11:56:00	0.000	1438	1440	248.9	253.9	286.0	302.7
2010/09/11	11:57:00	0.000	1437	1441	247.8	253.0	285.0	298.3
2010/09/11	11:58:00	0.000	1437	1438	248.6	253.9	285.1	296.5
2010/09/11	11:59:00	0.000	1438	1438	250.4	253.3	285.5	296.9
2010/09/11	12:00:00	0.000	1434	1438	250.4	252.7	288.7	296.6
2010/09/11	12:01:00	0.000	1436	1441	249.2	253.0	284.8	299.9
2010/09/11	12:02:00	0.000	1440	1447	249.1	253.3	282.5	295.4
2010/09/11	12:03:00	0.000	1441	1447	249.3	254.1	285.7	299.5
2010/09/11	12:04:00	0.000	1430	1442	250.6	253.0	283.8	296.5
2010/09/11	12:05:00	0.000	1429	1435	249.5	253.9	289.8	296.5
2010/09/11	12:06:00	0.000	1435	1441	250.1	253.9	287.0	305.1
2010/09/11	12:07:00	0.000	1439	1442	247.8	253.3	286.0	295.4
2010/09/11	12:08:00	0.000	1437	1442	250.4	252.2	283.0	298.1
2010/09/11	12:09:00	0.000	1435	1440	248.9	254.1	280.4	296.3
2010/09/11	12:10:00	0.000	1433	1437	250.1	253.6	286.0	304.8
2010/09/11	12:11:00	0.000	1435	1437	250.4	254.4	285.5	304.8
2010/09/11	12:12:00	0.000	1435	1436	249.5	253.0	283.9	296.3
2010/09/11	12:13:00	0.000	1436	1446	248.0	254.8	285.7	296.9
2010/09/11	12:14:00	0.000	1441	1446	248.9	253.9	281.0	297.7
2010/09/11	12:15:00	0.000	1440	1442	249.8	253.9	286.6	301.9
2010/09/11	12:16:00	0.000	1440	1444	250.9	254.1	288.6	303.0
2010/09/11	12:17:00	0.000	1431	1444	251.0	253.6	287.2	301.0

2010/09/11	12:18:00	0.000	1431	1434	249.6	252.4	283.0	299.4
2010/09/11	12:19:00	0.000	1434	1449	250.1	254.1	285.5	299.4
2010/09/11	12:20:00	0.000	1438	1448	250.4	254.8	282.0	297.6
2010/09/11	12:21:00	0.000	1429	1438	251.0	255.9	282.2	295.1
2010/09/11	12:22:00	0.000	1428	1435	250.1	253.9	284.8	295.1
2010/09/11	12:23:00	0.000	1434	1440	250.4	253.2	284.0	301.2
2010/09/11	12:24:00	0.000	1435	1439	249.8	253.9	285.5	293.9
2010/09/11	12:25:00	0.000	1435	1436	250.1	254.5	281.3	305.4
2010/09/11	12:26:00	0.000	1435	1437	248.6	253.0	282.5	303.6
2010/09/11	12:27:00	0.000	1437	1438	248.1	252.4	282.8	299.2
2010/09/11	12:28:00	0.000	1435	1446	250.1	252.7	282.0	301.0
2010/09/11	12:29:00	0.000	1445	1449	250.1	253.6	282.0	299.5
2010/09/11	12:30:00	0.000	1445	1447	250.5	254.4	284.0	299.2
2010/09/11	12:31:00	0.000	1437	1445	250.4	255.3	279.3	299.5
2010/09/11	12:32:00	0.000	1430	1437	252.2	255.7	279.4	294.8
2010/09/11	12:33:00	0.000	1431	1435	249.2	254.8	284.6	297.2
2010/09/11	12:34:00	0.000	1434	1436	249.2	255.4	283.4	303.1
2010/09/11	12:35:00	0.000	1433	1436	250.5	254.5	283.4	297.3
		<b>Average</b>	<b>1436</b>	<b>1440</b>	<b>249</b>	<b>253</b>		
				<b>1438</b>		<b>251</b>		

Date	Time	Ch. Tag Unit sec	CH001 FLARE 1 TEMP °F		CH003 FLARE 1 FLOW SCFM		CH005 LFG FLOW SCFM		
			MIN	MAX	MIN	MAX	MIN	MAX	
2010/09/11	14:00:00		0.000	1434	1439	231.0	234.8	263.6	281.3
2010/09/11	14:01:00		0.000	1439	1442	231.0	234.8	261.1	287.8
2010/09/11	14:02:00		0.000	1441	1445	230.4	235.1	263.4	285.3
2010/09/11	14:03:00		0.000	1443	1446	232.2	235.4	264.9	277.2
2010/09/11	14:04:00		0.000	1439	1444	232.7	235.1	267.6	278.1
2010/09/11	14:05:00		0.000	1433	1439	231.6	235.4	263.4	278.1
2010/09/11	14:06:00		0.000	1434	1439	231.9	235.7	264.7	283.1
2010/09/11	14:07:00		0.000	1431	1435	231.9	236.0	264.0	280.4
2010/09/11	14:08:00		0.000	1431	1432	232.2	235.4	264.0	280.2
2010/09/11	14:09:00		0.000	1432	1440	231.3	234.5	263.5	280.8
2010/09/11	14:10:00		0.000	1437	1444	230.7	234.0	263.1	278.1
2010/09/11	14:11:00		0.000	1444	1445	231.9	234.3	262.6	275.2
2010/09/11	14:12:00		0.000	1436	1445	232.7	235.7	263.8	278.7
2010/09/11	14:13:00		0.000	1436	1442	232.2	237.1	258.2	276.6
2010/09/11	14:14:00		0.000	1440	1442	230.4	234.9	264.9	279.0
2010/09/11	14:15:00		0.000	1433	1440	229.8	235.4	266.2	279.0
2010/09/11	14:16:00		0.000	1432	1439	230.7	234.8	262.0	275.2
2010/09/11	14:17:00		0.000	1438	1440	233.6	236.2	262.0	276.9
2010/09/11	14:18:00		0.000	1438	1443	233.6	236.6	260.2	276.1
2010/09/11	14:19:00		0.000	1443	1452	232.2	235.7	262.8	276.9
2010/09/11	14:20:00		0.000	1445	1452	231.3	235.0	258.2	278.7
2010/09/11	14:21:00		0.000	1423	1445	231.3	235.4	261.7	275.2
2010/09/11	14:22:00		0.000	1418	1423	231.9	235.1	257.0	279.3
2010/09/11	14:23:00		0.000	1421	1430	230.7	235.1	260.4	281.3
2010/09/11	14:24:00		0.000	1430	1438	229.8	234.8	264.0	275.2
2010/09/11	14:25:00		0.000	1438	1441	230.1	235.1	264.3	276.4
2010/09/11	14:26:00		0.000	1440	1442	231.0	235.9	262.9	279.0
2010/09/11	14:27:00		0.000	1440	1442	232.2	235.9	264.5	272.6
2010/09/11	14:28:00		0.000	1438	1440	231.6	235.4	260.8	274.7
2010/09/11	14:29:00		0.000	1437	1441	232.2	234.8	266.4	276.6
2010/09/11	14:30:00		0.000	1433	1437	232.2	236.9	255.6	272.2
2010/09/11	14:31:00		0.000	1433	1436	232.2	235.4	263.8	275.5
2010/09/11	14:32:00		0.000	1436	1439	232.2	236.0	265.8	272.2
2010/09/11	14:33:00		0.000	1435	1436	231.9	234.5	258.7	273.4
2010/09/11	14:34:00		0.000	1436	1441	231.0	235.1	261.7	273.9
2010/09/11	14:35:00		0.000	1438	1439	231.6	234.0	254.3	274.3
2010/09/11	14:36:00		0.000	1439	1444	232.7	236.9	260.5	273.7
2010/09/11	14:37:00		0.000	1441	1444	230.1	235.7	259.0	274.6
2010/09/11	14:38:00		0.000	1439	1444	231.3	235.2	259.8	273.1
2010/09/11	14:39:00		0.000	1437	1440	231.6	235.4	260.5	273.1
2010/09/11	14:40:00		0.000	1436	1439	231.9	236.6	260.1	271.7
2010/09/11	14:41:00		0.000	1433	1439	231.9	235.2	263.1	275.3
2010/09/11	14:42:00		0.000	1432	1434	232.5	235.1	258.7	278.1
2010/09/11	14:43:00		0.000	1433	1435	231.6	235.7	264.3	277.0
2010/09/11	14:44:00		0.000	1433	1436	231.6	235.7	264.6	278.4
2010/09/11	14:45:00		0.000	1433	1436	231.3	235.1	259.9	272.6
2010/09/11	14:46:00		0.000	1433	1437	231.3	235.7	262.0	273.4
2010/09/11	14:47:00		0.000	1437	1444	231.6	234.8	261.3	272.9
2010/09/11	14:48:00		0.000	1444	1447	231.0	234.8	257.8	271.4
2010/09/11	14:49:00		0.000	1444	1447	232.2	235.7	261.3	271.7
2010/09/11	14:50:00		0.000	1441	1447	232.5	236.9	256.9	292.2
2010/09/11	14:51:00		0.000	1437	1441	232.2	235.7	259.3	274.6

2010/09/11	14:52:00	0.000	1435	1438	232.2	236.0	261.3	279.3
2010/09/11	14:53:00	0.000	1438	1445	231.0	235.2	259.4	279.9
2010/09/11	14:54:00	0.000	1434	1443	232.5	235.2	256.9	279.9
2010/09/11	14:55:00	0.000	1430	1442	231.9	237.1	254.1	273.1
2010/09/11	14:56:00	0.000	1438	1443	233.1	236.3	260.2	273.1
2010/09/11	14:57:00	0.000	1435	1439	232.5	236.6	260.2	274.6
2010/09/11	14:58:00	0.000	1435	1439	233.6	236.6	260.4	276.6
2010/09/11	14:59:00	0.000	1430	1435	230.4	234.5	262.6	273.4
2010/09/11	15:00:00	0.000	1431	1440	229.8	235.2	263.7	271.3
2010/09/11	15:01:00	0.000	1438	1440	231.6	235.2	255.0	269.3
2010/09/11	15:02:00	0.000	1438	1442	231.9	235.4	256.9	271.1
2010/09/11	15:03:00	0.000	1437	1442	229.8	234.3	256.9	270.3
2010/09/11	15:04:00	0.000	1437	1443	232.2	235.7	255.7	275.7
2010/09/11	15:05:00	0.000	1438	1442	230.7	234.5	261.1	269.6
2010/09/11	15:06:00	0.000	1430	1438	231.0	234.0	256.7	270.5
2010/09/11	15:07:00	0.000	1430	1439	232.5	235.2	257.5	271.1
2010/09/11	15:08:00	0.000	1439	1441	230.1	234.3	261.0	270.0
2010/09/11	15:09:00	0.000	1438	1444	231.9	235.7	254.1	269.6
2010/09/11	15:10:00	0.000	1433	1438	231.9	235.7	260.8	271.1
2010/09/11	15:11:00	0.000	1433	1442	231.9	234.8	258.5	271.1
2010/09/11	15:12:00	0.000	1437	1442	231.9	235.4	259.9	269.0
2010/09/11	15:13:00	0.000	1436	1438	232.2	236.0	258.7	270.5
2010/09/11	15:14:00	0.000	1432	1436	230.4	234.5	256.1	269.0
2010/09/11	15:15:00	0.000	1435	1437	231.9	234.8	258.7	274.3
2010/09/11	15:16:00	0.000	1437	1440	231.3	236.3	255.9	274.3
2010/09/11	15:17:00	0.000	1440	1444	231.0	235.1	256.0	274.0
2010/09/11	15:18:00	0.000	1440	1442	231.9	234.8	257.3	269.9
2010/09/11	15:19:00	0.000	1433	1440	230.7	235.1	257.3	267.8
2010/09/11	15:20:00	0.000	1433	1434	230.7	234.5	253.4	270.8
2010/09/11	15:21:00	0.000	1433	1436	230.2	234.8	255.8	270.8
2010/09/11	15:22:00	0.000	1436	1441	231.0	234.3	256.1	272.9
2010/09/11	15:23:00	0.000	1439	1440	232.5	235.1	250.2	274.9
2010/09/11	15:24:00	0.000	1440	1442	231.6	235.1	261.7	279.3
2010/09/11	15:25:00	0.000	1442	1444	231.3	236.2	257.6	268.1
2010/09/11	15:26:00	0.000	1432	1442	231.6	236.6	255.2	269.0
2010/09/11	15:27:00	0.000	1432	1438	231.3	233.9	255.0	271.4
2010/09/11	15:28:00	0.000	1438	1440	231.3	234.3	258.1	266.4
2010/09/11	15:29:00	0.000	1440	1443	230.7	235.1	254.6	268.4
2010/09/11	15:30:00	0.000	1435	1444	230.1	234.8	255.5	270.2
2010/09/11	15:31:00	0.000	1433	1435	229.2	235.1	255.8	266.1
2010/09/11	15:32:00	0.000	1435	1440	229.2	233.9	259.0	270.4
2010/09/11	15:33:00	0.000	1438	1440	231.9	235.4	259.3	272.1
2010/09/11	15:34:00	0.000	1438	1444	231.0	234.0	256.2	270.8
2010/09/11	15:35:00	0.000	1435	1443	232.7	235.1	257.9	269.0
2010/09/11	15:36:00	0.000	1435	1444	233.6	235.2	258.7	272.5
2010/09/11	15:37:00	0.000	1429	1441	230.7	234.5	251.1	276.5
2010/09/11	15:38:00	0.000	1429	1436	231.6	235.1	255.8	271.1
2010/09/11	15:39:00	0.000	1436	1438	232.7	236.9	255.5	269.9
2010/09/11	15:40:00	0.000	1435	1438	230.1	234.3	258.3	269.9
2010/09/11	15:41:00	0.000	1436	1438	231.0	234.5	258.0	275.5
2010/09/11	15:42:00	0.000	1438	1441	230.4	234.3	256.9	269.3
2010/09/11	15:43:00	0.000	1439	1441	231.0	234.8	258.1	270.8
2010/09/11	15:44:00	0.000	1439	1442	231.9	235.1	253.7	273.4
2010/09/11	15:45:00	0.000	1441	1449	231.9	235.1	257.0	274.6
2010/09/11	15:46:00	0.000	1439	1449	231.6	235.4	251.4	267.8
2010/09/11	15:47:00	0.000	1429	1439	231.6	235.1	254.4	271.3

2010/09/11	15:48:00	0.000	1427	1429	231.3	234.5	252.6	269.4
2010/09/11	15:49:00	0.000	1427	1438	232.2	235.1	252.6	274.0
2010/09/11	15:50:00	0.000	1434	1440	230.1	235.1	256.7	274.9
2010/09/11	15:51:00	0.000	1432	1434	231.9	235.3	256.7	267.2
2010/09/11	15:52:00	0.000	1432	1434	232.7	235.1	256.4	273.7
2010/09/11	15:53:00	0.000	1434	1448	231.6	235.4	252.6	267.7
2010/09/11	15:54:00	0.000	1448	1456	232.7	236.2	255.8	270.5
2010/09/11	15:55:00	0.000	1438	1455	231.9	236.1	255.2	266.3
2010/09/11	15:56:00	0.000	1435	1439	233.0	235.4	254.3	267.8
2010/09/11	15:57:00	0.000	1434	1438	230.7	235.4	254.3	267.2
2010/09/11	15:58:00	0.000	1430	1435	229.8	234.0	258.6	272.9
2010/09/11	15:59:00	0.000	1431	1438	231.6	235.7	249.4	275.1
2010/09/11	16:00:00	0.000	1438	1447	232.2	235.7	258.7	272.5
2010/09/11	16:01:00	0.000	1435	1445	231.0	235.1	249.4	264.9
2010/09/11	16:02:00	0.000	1431	1435	231.6	234.5	255.2	268.5
2010/09/11	16:03:00	0.000	1431	1443	231.0	236.2	255.8	269.0
2010/09/11	16:04:00	0.000	1435	1443	232.2	236.2	255.0	267.2
2010/09/11	16:05:00	0.000	1436	1442	231.8	235.1	256.0	271.7
		<b>Average</b>	<b>1435</b>	<b>1441</b>	<b>232</b>	<b>235</b>		
				<b>1438</b>		<b>233</b>		



## **Appendix J**

### **Quality Assurance/Quality Control**



Air Liquide America  
Specialty Gases LLC



**COMPLIANCE CLASS**  
*Dual-Analyzed Calibration Standard*

8832 DICE ROAD, SANTA FE SPRINGS, CA 90670-2516

Phone: 800-323-2212

Fax: 562-464-5262

**CERTIFICATE OF ACCURACY: EPA Protocol Gas**

Assay Laboratory

AIR LIQUIDE AMERICA SPECIALTY GASES LLC  
8832 DICE ROAD  
SANTA FE SPRINGS, CA 90670-2516

P.O. No.: CORIS DOC# 37948219  
Project No.: 02-71968-001

Customer

TOTAL AIR ANALYSIS

**ANALYTICAL INFORMATION**

This certification was performed according to EPA Traceability Protocol For Assay & Certification of Gaseous Calibration Standards; Procedure G-1; September, 1997.

Cylinder Number: **CC70263**      Certification Date: **26Jul2010**      Exp. Date: **25Jul2012**  
Cylinder Pressure\*\*\*: **1900 PSIG**      Batch No: **SBO0025087**

<u>COMPONENT</u>	<u>CERTIFIED CONCENTRATION (Moles)</u>	<u>ACCURACY**</u>	<u>TRACEABILITY</u>
NITRIC OXIDE	41.6 PPM	+/- 2%	NIST and VSL
NITROGEN - OXYGEN FREE	BALANCE		
TOTAL OXIDES OF NITROGEN	41.6 PPM		Reference Value Only

\*\*\* Do not use when cylinder pressure is below 150 psig.

\*\* Analytical accuracy is based on the requirements of EPA Protocol procedures, September 1997.

**REFERENCE STANDARD**

<u>TYPE/SRM NO.</u>	<u>EXPIRATION DATE</u>	<u>CYLINDER NUMBER</u>	<u>CONCENTRATION</u>	<u>COMPONENT</u>
NTRM 1683	25Jul2012	KAL004267	50.96 PPM	NITRIC OXIDE

**INSTRUMENTATION**

<u>INSTRUMENT/MODEL/SERIAL#</u>	<u>DATE LAST CALIBRATED</u>	<u>ANALYTICAL PRINCIPLE</u>
TIR/001785245	09Jul2010	FTIR

APPROVED BY:

*Thuan Tran*  
\_\_\_\_\_  
Thuan Tran

## CERTIFICATE OF ANALYSIS

### Grade of Product: EPA Protocol

Airgas Specialty Gases  
11711 S. Alameda Street  
Los Angeles, CA 90059-2130  
(323) 357-6891  
Fax: (323) 567-3686  
www.airgas.com

Part Number: E02NI99E15AC1S8      Reference Number: 48-124203748-9  
Cylinder Number: CC14717      Cylinder Volume: 144 Cu.Ft.  
Laboratory: ASG - Los Angeles - CA      Cylinder Pressure: 2015 PSIG  
Analysis Date: Jan 21, 2010      Valve Outlet: 660

Expiration Date: Jan 21, 2012

Certification performed in accordance with "EPA Traceability Protocol (Sept. 1997)" using the assay procedures listed. Analytical Methodology does not require correction for analytical interferences. This cylinder has a total analytical uncertainty as stated below with a confidence level of 95%. There are no significant impurities which affect the use of this calibration mixture. All concentrations are on a volume/volume basis unless otherwise noted.  
Do Not Use This Cylinder below 150 psig, i.e. 1 Mega Pascal

#### ANALYTICAL RESULTS

Component	Requested Concentration	Actual Concentration	Protocol Method	Total Relative Uncertainty
NOx	23.00 PPM	23.64 PPM	G1	+/- 1% NIST Traceable
NITRIC OXIDE	23.00 PPM	23.37 PPM	G1	+/- 1% NIST Traceable
NITROGEN	Balance			

#### CALIBRATION STANDARDS

Type	Lot ID	Cylinder No	Concentration	Expiration Date
NTRM	080607	CC207823	17.25PPM NITRIC OXIDE/NITROGEN	Sep 01, 2011
NTRM	080608NOx	CC207823	17.38PPM NOx/NITROGEN	Sep 01, 2011

#### ANALYTICAL EQUIPMENT

Instrument/Make/Model	Analytical Principle	Last Multipoint Calibration
California Analytical NO	CLD NO	Dec 31, 2009
California Analytical NOx	CLD NOx	Dec 31, 2009

Triad Data Available Upon Request

Notes:

\_\_\_\_\_  
QA Approval



AIR LIQUIDE

# CERTIFICATION OF ANALYSIS

Interference Free Multi-Component EPA Protocol Gases  
Note: Analytical uncertainty and NIST traceability are in compliance with EPA-600/R-97/121  
Section 2.2, Procedure G-1

Customer: TOTAL AIR ANALYSIS INC.  
Location: CARSON, CA

Cylinder S/N: CC259945

Shipping Order Number: 30637554  
Transfer Number:  
Lot Number: SFS124497  
Valve: CGA 350  
Cylinder Pressure\*: 2000 PSIG  
\*Cylinder should not be used when  
gas pressure is below 150 psig

P.O. Number: VERBAL

Assay Date: 15-Sep-2008

Expiration Date: 15-Sep-2011

Components	Requested Concentration	Assay Concentration
Nitrogen	Balance	Balance
Carbon Monoxide	85-90 ppm	87.4 ± 0.9 ppm

### Reference Standard(s) Employed For Analysis

Certified Concentration and Uncertainty	Component	Balance	Cyl. No.	SRM/PRM/Mix No.	Exp. Date	Sample No.	Type
99.75 ± 0.42 ppm	Carbon Monoxide	Nitrogen	CC245791	SFS104998	26-Sep-2009	BT	GMIS

### Analytical Data

Component:	Carbon Monoxide	FIRST TRIAD ANALYSIS 8-Sep-2008			Units	SECOND TRIAD ANALYSIS 15-Sep-2008			Units		
		Trial 1	Trial 2	Trial 3		Trial 1	Trial 2	Trial 3			
Analyzer Information	Gas Chromatograph	Zero	0.0000	0.0000	0.0000	Area	Zero	0.0000	0.0000	Area	
Analyzer Type:	Hewlett Packard	Reference	808.19	808.15	808.15	Area	Reference	813.13	813.88	813.57	Area
Manufacturer:	G1540A	Candidate	707.55	707.73	707.73	Area	Candidate	712.12	712.68	712.63	Area
Model Number:	US00003390/Meth	Result	87.33	87.36	87.36	ppm	Result	87.36	87.35	87.37	ppm
Serial Number:	15-Sep-2008	Evaluation	Valid	Valid	Valid		Evaluation	Valid	Valid	Valid	
MPR Last Calibrated:											
Analytical Principle:	FID & TCD										
			Mean Analytical Result:			87.35 ppm		Mean Analytical Result:			87.36 ppm

Analyst:

Tan Ngo

Approved by:

Thuan Tran

## CERTIFICATE OF ANALYSIS

### Grade of Product: EPA Protocol

Airgas Specialty Gases  
11711 S. Alameda Street  
Los Angeles, CA 90059-2130  
(323) 357-6891  
Fax: (323) 567-3686  
www.airgas.com

Part Number: E03NI60E15A1069      Reference Number: 48-124226779-1  
Cylinder Number: CC281937      Cylinder Volume: 158 Cu.Ft.  
Laboratory: ASG - Los Angeles - CA      Cylinder Pressure: 2015 PSIG  
Analysis Date: Jul 27, 2010      Valve Outlet: 590

Expiration Date: Jul 27, 2013

Certification performed in accordance with "EPA Traceability Protocol (Sept. 1997)" using the assay procedures listed. Analytical Methodology does not require correction for analytical interferences. This cylinder has a total analytical uncertainty as stated below with a confidence level of 95%. There are no significant impurities which affect the use of this calibration mixture. All concentrations are on a volume/volume basis unless otherwise noted.  
Do Not Use This Cylinder below 150 psig, i.e. 1 Mega Pascal

#### ANALYTICAL RESULTS

Component	Requested Concentration	Actual Concentration	Protocol Method	Total Relative Uncertainty
CARBON DIOXIDE	18.00 %	18.35 %	G1	+/- 1% NIST Traceable
OXYGEN	22.00 %	22.21 %	G1	+/- 1% NIST Traceable
NITROGEN	Balance			

#### CALIBRATION STANDARDS

Type	Lot ID	Cylinder No	Concentration	Expiration Date
NTRM	060608	CC207972	22.51% OXYGEN/NITROGEN	May 01, 2016
NTRM	040604	XC034335B	19.84% CARBON DIOXIDE/NITROGEN	May 15, 2012

#### ANALYTICAL EQUIPMENT

Instrument/Make/Model	Analytical Principle	Last Multipoint Calibration
SIEMENS % CO2	NDIR	Jul 12, 2010
Siemens %O2	PARAMAGNETIC	Jul 12, 2010

Triad Data Available Upon Request

Notes:



Approved for Release

## CERTIFICATE OF ANALYSIS

### Grade of Product: EPA Protocol

Airgas Specialty Gases  
11711 S. Alameda Street  
Los Angeles, CA 90059-2130  
(323) 357-6891  
Fax: (323) 567-3686  
www.airgas.com

Part Number: E03NI82E15A0220      Reference Number: 48-124226526-1  
Cylinder Number: CC197745      Cylinder Volume: 150 Cu.Ft.  
Laboratory: ASG - Los Angeles - CA      Cylinder Pressure: 2015 PSIG  
Analysis Date: Jul 16, 2010      Valve Outlet: 590

Expiration Date: Jul 16, 2013

Certification performed in accordance with "EPA Traceability Protocol (Sept. 1997)" using the assay procedures listed. Analytical Methodology does not require correction for analytical interferences. This cylinder has a total analytical uncertainty as stated below with a confidence level of 95%. There are no significant impurities which affect the use of this calibration mixture. All concentrations are on a volume/volume basis unless otherwise noted.  
Do Not Use This Cylinder below 150 psig.i.e. 1 Mega Pascal

#### ANALYTICAL RESULTS

Component	Requested Concentration	Actual Concentration	Protocol Method	Total Relative Uncertainty
CARBON DIOXIDE	9.000 %	9.117 %	G1	+/- 1% NIST Traceable
OXYGEN	9.000 %	9.060 %	G1	+/- 1% NIST Traceable
NITROGEN	Balance			

#### CALIBRATION STANDARDS

Type	Lot ID	Cylinder No	Concentration	Expiration Date
NTRM	82658	SG9162882	9.507% OXYGEN/	Dec 01, 2015
NTRM	81674	SG9198971	10.818% CARBON DIOXIDE/NITROGEN	May 15, 2012

#### ANALYTICAL EQUIPMENT

Instrument/Make/Model	Analytical Principle	Last Multipoint Calibration
SIEMENS % CO2	NDIR	Jul 12, 2010
Siemens %O2	PARAMAGNETIC	Jul 12, 2010

Triad Data Available Upon Request

Notes:

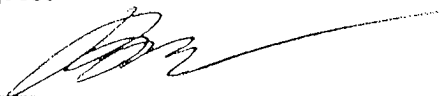

Approved for Release

DRY GAS METER CALIBRATION DATA SHEET

Control Console I.D.: Apex 1  
 Reference Meter Y: 0.9991  
 Date: 7/21/10  
 Pber: 29.91  
 Ambient Temp.: 71

Calibration Frequency: Annual  
 Standard Temp. 68

Rate (CFM)	dh	Field Dry Gas Meter		Reference Wet Gas Meter		Yfm	dh@
		Temp Out (OF)	Meter Reading (CF)	Temp Out (OF)	Meter Reading (CF)		
0.25	start	70	310.000	70	835.000	1.0049	2.301
	end	70	317.450	71	842.500		
	avg/total	70.0	7.450	70.5	7.500		
0.25	start	71	317.450	70	842.500	1.0093	2.234
	end	70	324.980	70	850.100		
	avg/total	70.5	7.530	70.0	7.600		
0.25	start	71	324.980	71	850.100	1.0062	2.303
	end	70	332.420	71	857.600		
	avg/total	70.5	7.440	71.0	7.500		
0.5	start	71	333.000	71	858.000	0.9942	2.278
	end	71	343.100	71	868.050		
	avg/total	71	10.100	71	10.050		
0.5	start	71	343.100	71	868.050	0.9951	2.280
	end	72	353.190	71	878.090		
	avg/total	71.5	10.090	71	10.040		
0.5	start	72	353.190	71	878.090	0.9980	2.296
	end	72	363.220	72	888.100		
	avg/total	72	10.030	71.5	10.010		
0.75	start	72	364.000	72	890.000	0.9951	1.998
	end	72	371.530	72	897.500		
	avg/total	72	7.530	72	7.500		
0.75	start	71	371.530	72	897.500	0.9955	1.973
	end	72	379.100	72	905.050		
	avg/total	71.5	7.570	72	7.550		
0.75	start	72	379.100	72	905.050	0.9974	1.989
	end	72	386.630	71	912.560		
	avg/total	72	7.530	71.5	7.510		
1.00	start	71	388.000	71	914.000	0.9941	2.013
	end	71	398.050	71	924.000		
	avg/total	71	10.050	71	10.000		
1.00	start	71	398.050	70	924.000	0.9961	1.968
	end	70	408.190	70	934.100		
	avg/total	70.5	10.140	70	10.100		
1.00	start	71	408.190	70	934.100	0.9971	1.988
	end	70	418.270	70	944.150		
	avg/total	70.5	10.080	70	10.050		

Rate (CFM)	Run No.	Reference Wet Gas Meter			Field Dry Gas Meter			Coefficient Y<math>\pm</math> (0.05)	Ymax-Ymin<math>\times</math> 0.01	Average dh@	dh@ (dh<math>\pm</math> 0.15)	0.98<math>\times</math> (Y/D) <math><1.02</math>
		Rate Qm (cfm)	Avg. Meter Temp.	Corr. Rate (scfm)	Rate Qm (cfm)	Avg. Meter Temp.	Corr. Rate (scfm)					
0.25	1	0.2500	70.5	0.2488	0.2483	70.0	0.2473	1.0049	0.0045	2.279	0.144	1.0082
	2	0.2533	70.0	0.2523	0.2510	70.5	0.2497	1.0093				
	3	0.2500	71.0	0.2485	0.2480	70.5	0.2468	1.0062				
0.5	1	0.5025	71	0.4986	0.5050	71	0.5011	0.9942	0.0039	2.285	0.150	0.9972
	2	0.5020	71	0.4981	0.5045	71.5	0.5001	0.9951				
	3	0.5005	71.5	0.4962	0.5015	72	0.4967	0.9980				
0.75	1	0.75	72	0.7411	0.7530	72	0.7440	0.9951	0.0023	1.987	0.149	0.9974
	2	0.755	72	0.7460	0.7570	71.5	0.7487	0.9955				
	3	0.751	71.5	0.7427	0.7530	72	0.7440	0.9974				
1.00	1	1	71	0.9862	1.0050	71	0.9911	0.9941	0.0029	1.990	0.146	0.9972
	2	1.01	70	0.9979	1.014	70.5	1.0009	0.9961				
	3	1.01	70	0.9979	1.014	70.5	1.0009	0.9971				

Overall Averages  
 $dh@ = 2.135$   $Y = 0.9986$

HOMER R. DULIN CO.  
 729 EAST WILLOW STREET  
 SIGNAL HILL, CALIFORNIA 90755  
 (562) 424-8533 FAX (562) 426-7707  
 CERT. NO. 7-320-10

## CALIBRATION CERTIFICATION

SUBMITTED BY: TOTAL AIR ANALYSIS, INC.

FLOWMETER SERIAL NO: 801003 MFG. SERIAL NO: 1036  
 MANUFACTURER: EQUIMETER MODEL: S-110  
 TUBE NO: N/A FLOAT NO: N/A

DATA IS: As Found/As Left ; In Tolerance

See Remarks

Calibrated @ customer's facility

REMARKS: CALIBRATED IN CFH AIR @ 14.7 PSIA & 70° F. METER CALIBRATED WITH CUSTOMER'S ORIFICE IN IN OUTLET.

ACCURACY ± 1% RATE

INDICATED		ACTUAL	
CFH		CFH	
130.3		129.2	
120.6		119.9	
108.3		107.7	
96.9		96.6	
85.3		84.9	
73.2		73.1	
61.5		61.3	
48.5		48.4	
36.0		35.9	
22.5		22.6	

Flowmeter Certified with HOMER R. DULIN CO.

Equip. No. 12400 Accuracy 0.20% Equip. Cal. Date: 4/23/09 Cal. Due: 4/23/12

NIST Cert. No. 821/276270-08 Procedure No: 101G Rev 3

Our standards are certified by or are traceable to the National Institute of Standards and Technology and systems comply with MIL-STD 45662A, ANSI/NCSL Z540, ISO Guide 25, FDA/CGMP 820.72, and ISO 10012. The collective uncertainty of the standards used in this calibration does not exceed 25% of the certified accuracy of the instrument under test. This document may not be reproduced, except in full, without prior written approval of the Homer R. Dulin Co.

P.O. No. \_\_\_\_\_ Shipper No. \_\_\_\_\_

7-21-10 CALIBRATION DATE 7-21-11 RECALIBRATION DUE J. LAGUNA CALIBRATION TECHNICIAN



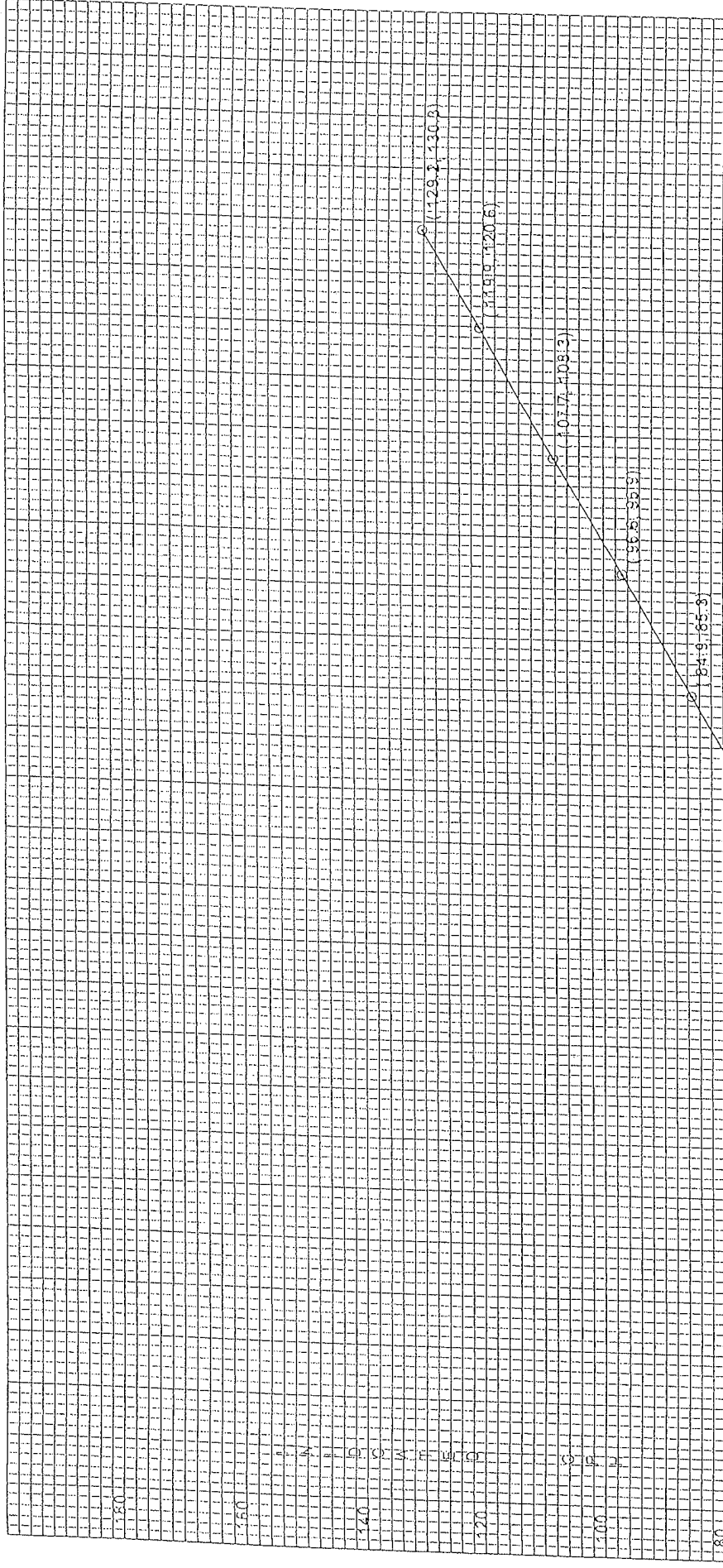

CALIBRATION CURVE BY  
 HOMER R. DULIN CO. Certificate #7-320-10  
 Submitted By: TOTAL AIR ANALYSIS, INC.

Flowmeter S/N: 801003  
 Mfr. S/N: EQUIMETER 1035  
 Tube: N/A  
 Model: S-110  
 Date: 7-21-10  
 Technician: J. LAGUNA  
 Accuracy: ± 1% RATE

ACTUAL FLOW OF AIR @ 47.75 PSI @ 8.170 F

Current	Flow
22.5	27.5
35.0	36
48.4	48.5
61.5	61.5
73.2	73.2
84.9	85.3
96.5	96.5
107.7	108.3
119.0	120.6
129.2	130.2

# DRY GAS METER CALIBRATION DATA SHEET

Control Console I.D.: Apex 2  
 Reference Meter Y: 0.9991  
 Date: 7/23/2010  
 Phat: 29.95  
 Ambient Temp.: 73

Calibration Frequency: Annual  
 Standard Temp. 68

Rate (CFM)	dH	Field Dry Gas Meter			Reference Dry Gas Meter			Y <sub>fm</sub>	dH@
		Temp Out (°F)	Meter Reading (CF)	Time	Temp. Out (°F)	Meter Reading (CF)			
0.25	start	72	525.000	0	72	950.000			
	end	72	532.505	30	73	957.490	0.9962	2.313	
	avg/total	72	7.505	30	72.5	7.490			
0.25	start	72	532.505	0	72	957.490			
	end	73	540.010	30	72	964.979	0.9979	2.307	
	avg/total	72.5	7.505	30	72	7.489			
0.25	start	73	540.010	0	73	964.979			
	end	73	547.505	30	73	972.480	0.9999	2.306	
	avg/total	73	7.495	30	73	7.501			
0.5	start	73	550.000	0	73	975.000			
	end	73	560.075	20	73	985.060	0.9976	2.279	
	avg/total	73	10.075	20	73	10.060			
0.5	start	73	560.075	0	72	985.060			
	end	72	570.140	20	72	995.100	0.9976	2.282	
	avg/total	72.5	10.065	20	72	10.040			
0.5	start	72	570.140	0	72	995.100			
	end	72	580.200	20	72	1005.150	0.9981	2.279	
	avg/total	72	10.060	20	72	10.050			
0.75	start	72	585.000	0	72	10.000			
	end	71	592.580	10	72	17.550	0.9942	1.870	
	avg/total	71.5	7.580	10	72.5	7.550			
0.75	start	72	592.580	0	72	17.550			
	end	72	600.200	10	72	25.150	0.9965	1.843	
	avg/total	72	7.620	10	72	7.600			
0.75	start	72	600.200	0	73	25.150			
	end	72	607.790	10	73	32.720	0.9946	1.865	
	avg/total	72	7.590	10	73	7.570			
1.00	start	72	610.000	0	73	35.000			
	end	73	620.120	10	73	45.100	0.9962	2.263	
	avg/total	72.5	10.120	10	73	10.100			
1.00	start	72	620.120	0	72	45.100			
	end	73	630.150	10	72	55.105	0.9975	2.298	
	avg/total	72.5	10.030	10	72	10.005			
1.00	start	73	630.150	0	72	55.105			
	end	72	640.200	10	72	65.120	0.9966	2.293	
	avg/total	72.5	10.050	10	72	10.015			

Rate (CFM)	Run No.	Reference Dry Gas Meter			Field Dry Gas Meter			Coefficient Y<(1+/-0.05)>	(Y <sub>max</sub> -Y <sub>min</sub> )<0.01	Average Y	Average dH@ (-0.15)	dH@<0.98<CY>> .02
		Rate Q <sub>m</sub> (cfm)	Avg. Meter Temp.	Corr. Rate (scfm)	Rate Q <sub>m</sub> (cfm)	Avg. Meter Temp.	Corr. Rate (scfm)					
0.25	1	0.2497	72.5	0.2472	0.2502	72.0	0.2479	0.9962				
	2	0.2496	72.0	0.2474	0.2502	72.5	0.2477	0.9979				
	3	0.2500	73.0	0.2473	0.2498	73.0	0.2471	0.9999				
0.5	1	0.5030	73	0.4966	0.5038	73	0.4973	0.9976				
	2	0.5020	72	0.4965	0.5032	72.5	0.4973	0.9976				
	3	0.5025	72	0.4970	0.5030	72	0.4975	0.9981				
0.75	1	0.755	72	0.7452	0.7580	71.5	0.7489	0.9942				
	2	0.76	72	0.7501	0.7620	72	0.7521	0.9965				
	3	0.757	73	0.7458	0.7590	72	0.7491	0.9946				
1.00	1	1.01	73	0.9898	1.0120	72.5	0.9927	0.9962				
	2	1.0005	72	0.9823	1.003	72.5	0.9839	0.9975				
	3	1.0005	72	0.9823	1.003	72.5	0.9839	0.9966				

Overall Averages  $\bar{dH@} = 2.183$   $\bar{Y} = 0.9969$



**HOMER R. DULIN CO.**  
 729 EAST WILLOW STREET  
 SIGNAL HILL, CALIFORNIA 90755  
 (562) 424-8533 FAX (562) 426-7707

CERT. NO. 7-321-10

**CALIBRATION CERTIFICATION**

SUBMITTED BY: TOTAL AIR ANALYSIS, INC.

FLOWMETER SERIAL NO: \_\_\_\_\_ MFG. SERIAL NO: 967239

MANUFACTURER: ROCKWELL MODEL: S-110

TUBE NO: N/A FLOAT NO: N/A

DATA IS: As Found/As Left ; In Tolerance with curve See Remarks

Calibrated @ customer's facility

REMARKS: CALIBRATED IN CFH AIR @ 14.7 PSIA & 70° F. METER CALIBRATED WITH CUSTOMER'S ORIFICE IN OUTLET -

ACCURACY ± 1% RATE W/ CURVE

INDICATED		ACTUAL	
CFH		CFH	
131.6		132.9	
120.8		121.9	
106.0		106.6	
95.3		95.8	
83.5		84.0	
71.9		72.1	
62.0		61.3	
48.2		47.8	
37.3		37.0	
22.4		22.4	

Flowmeter Certified with HOMER R. DULIN CO.

Equip. No. 12400 Accuracy 0.20% Equip. Cal. Date: 4/23/09 Cal. Due: 4/23/12

NIST Cert. No. 821/276270-08 Procedure No: 101G Rev 3

Our standards are certified by or are traceable to the National Institute of Standards and Technology and systems comply with MIL-STD 45662A, ANSI/NCSL Z540, ISO Guide 25, FDA/CGMP 820.72, and ISO 10012. The collective uncertainty of the standards used in this calibration does not exceed 25% of the certified accuracy of the instrument under test. This document may not be reproduced, except in full, without prior written approval of the Homer R. Dulin Co.

P.O. No. \_\_\_\_\_ Shipper No. \_\_\_\_\_

7-22-10  
CALIBRATION DATE

7-22-11  
RECALIBRATION DUE

J. LAGUNA   
CALIBRATION TECHNICIAN

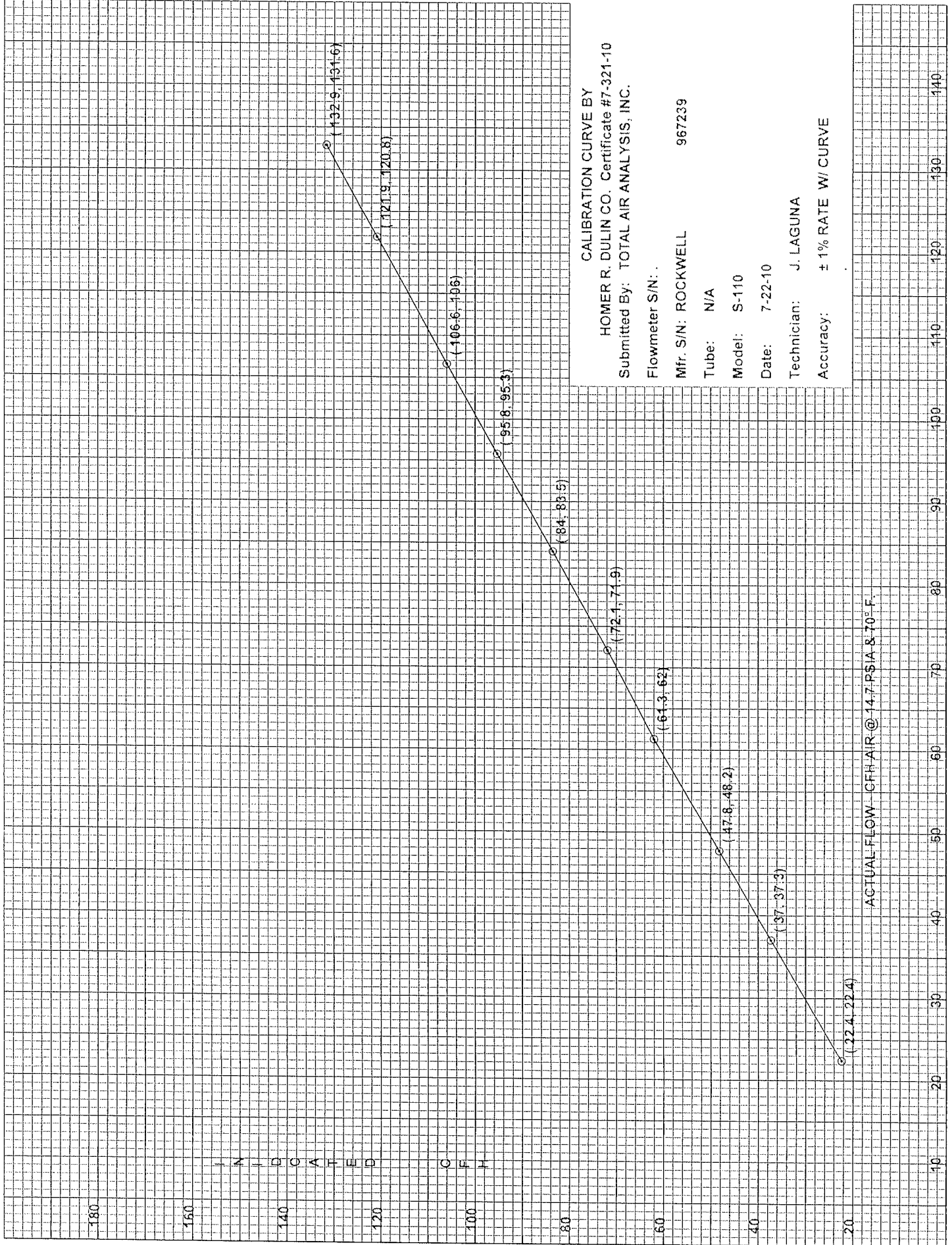

CALIBRATION CURVE BY

HOMER R. DULIN CO. Certificate #7-321-10

Submitted By: TOTAL AIR ANALYSIS, INC.

Flowmeter S/N: .

Mfr. S/N: ROCKWELL 967239

Tube: N/A

Model: S-110

Date: 7-22-10

Technician: J. LAGUNA

Accuracy: ± 1% RATE W/ CURVE

ACTUAL FLOW CFH AIR @ 14.7 PSIA & 70°F

**DRY GAS METER CALIBRATION DATA SHEET**

Control Console I.D.: SK-25, Mini Meter  
 Reference Meter Y: 0.9989  
 Date: 9/15/10  
 Pbar: 29.96  
 Ambient Temp.: 73

Calibration Frequency: Semiannual  
 Standard Temp. 68

Rate (CFM)	dH	Field Dry Gas Meter			Reference Dry Gas Meter			Yfm	dH@
		Temp Out (OF)	Meter Reading (CF)	Time	Temp. Out (OF)	Meter Reading (CF)			
0.25	start	0.25	71	210.780	0	72	153.514	0.9922	2.114
	end	0.25	71.5	218.653	30	72	161.345		
	avg/total	0.25	71.3	7.873	30	72.0	7.831		
0.25	start	0.25	71	218.653	0	72	161.345	0.9951	2.221
	end	0.25	72	226.313	30	71	168.976		
	avg/total	0.25	71.5	7.660	30	71.5	7.631		
0.25	start	0.25	72	226.313	0	72	168.976	0.9941	2.293
	end	0.25	72	233.863	30	71	176.483		
	avg/total	0.25	72.0	7.550	30	71.5	7.507		
0.5	start	1	72	235.500	0	73	177.534	0.9928	2.109
	end	1	72	246.011	20	72.5	187.996		
	avg/total	1	72	10.511	20	72.75	10.462		
0.5	start	1	71.5	246.011	0	72.5	187.996	0.9921	2.102
	end	1	72	256.543	20	73	198.476		
	avg/total	1	71.75	10.532	20	72.75	10.480		
0.5	start	1	72	256.543	0	73	198.476	0.9848	2.093
	end	1	73	267.184	20	73	208.977		
	avg/total	1	72.5	10.641	20	73	10.501		
0.75	start	1.95	73	270.000	0	73	210.750	1.0181	1.868
	end	1.95	73	277.610	10	73	218.506		
	avg/total	1.95	73	7.610	10	73	7.756		
0.75	start	1.95	73	277.610	0	74	218.506	1.0081	1.993
	end	1.95	73.5	285.054	10	73	226.022		
	avg/total	1.95	73.25	7.444	10	73.5	7.516		
0.75	start	1.95	73	285.054	0	74	226.022	1.0096	1.994
	end	1.95	74	292.485	10	74	233.540		
	avg/total	1.95	73.5	7.431	10	74	7.518		
1.00	start	4.25	74	293.500	0	74	235.000	0.9825	1.821
	end	4.25	74	305.304	10	74	246.610		
	avg/total	4.25	74	11.804	10	74	11.610		
1.00	start	4.25	73.5	305.304	0	74	246.610	0.9883	1.844
	end	4.25	74	316.961	10	74.5	258.154		
	avg/total	4.25	73.75	11.657	10	74.25	11.544		
1.00	start	4.25	74	316.961	0	73	258.154	1.0195	1.746
	end	4.25	74	328.579	10	74	270.000		
	avg/total	4.25	74	11.618	10	73.5	11.846		

Rate (CFM)	Run No.	Reference Dry Gas Meter			Field Dry Gas Meter			coefficient Y<(1+/-0.05)	(Ymax-Ymin)<0.01	Average Y	Average dH@	dH@<dH@ (+/- 0.15)	0.98<CYD <1.02
		Rate Qm (cfm)	Avg. Meter Temp.	Corr. Rate (scfm)	Rate Qm (cfm)	Avg. Meter Temp.	Corr. Rate (scfm)						
0.25	1	0.2610	72.0	0.2586	0.2624	71.3	0.2603	0.9922	0.0029	0.9938	2.209	0.193	0.9957
	2	0.2544	71.5	0.2522	0.2553	71.5	0.2532	0.9951					
	3	0.2502	71.5	0.2481	0.2517	72.0	0.2493	0.9941					
0.5	1	0.5231	72.75	0.5165	0.5256	72	0.5196	0.9928	0.0080	0.9899	2.101	0.085	0.9918
	2	0.5240	72.75	0.5174	0.5266	71.75	0.5209	0.9921					
	3	0.5251	73	0.5182	0.5321	72.5	0.5256	0.9848					
0.75	1	0.7756	73	0.7636	0.7610	73	0.7493	1.0181	0.0100	1.0119	1.952	0.065	1.0139
	2	0.7516	73.5	0.7393	0.7444	73.25	0.7326	1.0081					
	3	0.7518	74	0.7388	0.7431	73.5	0.7310	1.0096					
1.00	1	1.161	74	1.1346	1.1804	74	1.1535	0.9825	0.0370	0.9967	1.804	0.213	0.9986
	2	1.1544	74.25	1.1276	1.1657	73.75	1.1397	0.9883					
	3	1.1544	73.5	1.1292	1.1657	74	1.1392	1.0195					

Overall Averages  
 $dH@ = 2.016$   $Y = 0.9981$

# TOTAL AIR ANALYSIS, INC.

## Temperature Sensor Calibration

TC I.D #: TC-68  
Date: 9/15/2010  
Calibrator: Jofra 600S S/N 54005  
Calibrated By: JD Grissom  
Note: Calibrated with Extech 421305

<b>100 ° F</b>			
<i>Ref. Thermometer, (° F)</i>	<i>Field TC, (° F)</i>	<i>Absolute Difference</i>	<i>Difference, (° Rankin)</i>
96	96	0.00	0.00
96	96	0.00	0.00
96	96	0.00	0.00

<b>300 ° F</b>			
<i>Ref. Thermometer, (° F)</i>	<i>Field TC, (° F)</i>	<i>Absolute Difference</i>	<i>Difference, (° Rankin)</i>
300	303	-1.00	-0.39
300	303	-1.00	-0.39
300	303	-1.00	-0.39

<b>800 ° F</b>			
<i>Ref. Thermometer, (° F)</i>	<i>Field TC, (° F)</i>	<i>Absolute Difference</i>	<i>Difference, (° Rankin)</i>
800	801	-0.13	-0.08
800	801	-0.13	-0.08
800	801	-0.13	-0.08

**TOTAL AIR ANALYSIS, INC.**

## Santa Maria, California

Local Time: 3:00 PM PDT (GMT -07) — [Set My Timezone](#)

Lat/Lon: 34.9° N 120.3° W ([Google Map](#))

Tropical Weather: [Tropical Depression Igor](#) (North Atlantic) [Invest 92](#) (North Atlantic) [Typhoon Meranti](#) (Western Pacific) [Invest 95](#) (Central Pacific) [Invest 96](#) (Central Pacific)

Broadcast Network: Three Shows on the Broadcast Network today, beginning at 4 p.m. ET, 1 p.m PT. [Listen here!](#)

### Current Conditions

Santa Maria, California (PWS)

Updated: 2 sec ago



**64.1 °F**  
**Clear**

Humidity: **68%**  
Dew Point: **53 °F**  
Wind: **20.0 mph** from the **WNW**  
Wind Gust: **22.0 mph**  
Pressure: **29.94 in (Falling)**  
Visibility: **9.0 miles**  
UV: **2.4** out of 16  
Pollen: **8.10** out of 12  
[Pollen Forecast](#) NEW!  
Clouds: **Clear**  
(Above Ground Level)  
Elevation: **0 ft**

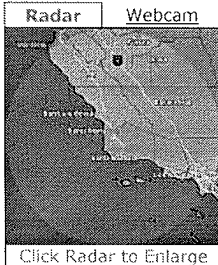

- [Local Radar](#)
- [WunderMap](#)
- [Regional Radar](#)
- [Local Satellite](#)
- [Marine Forecast](#)
- [Snow Depth](#)
- [Trip Planner](#)
- [Weather Stations](#)

#### Rapid Fire Updates:

Enable  Disable

#### Source for Current Conditions:

PWS & Airport  Airport Only

#### » [Weather History for This Location](#)

Select a source for your current conditions:

Santa Maria, CA

[Raw METAR](#)   [Aviation](#)   [Weather Radio](#)

Flight Rule: **VFR (KSMX)**  
Wind Speed: **20.0 kts.**  
Wind Dir: **311° (NW)**  
Ceiling: **Unlimited**

[Full Report](#) — [Pilot Maps](#)



#### Self Serve Advertising!

Promote your business to your local community on wunderground.com. Try us today with a free \$50 credit!

[click to learn more](#)

### Nearby Airports

City:	Temp.:	Conditions:	Updated:
<a href="#">Santa Maria</a>	67 °F	Clear	2:51 PM PDT
<a href="#">Lompoc</a>	68 °F	Clear	2:55 PM PDT
<a href="#">Vandenberg AFB</a>	63 °F	Partly Cloudy	2:55 PM PDT

### Flight Tracker Arrivals

Flight:      From:      To:      ETA:      Status:  
No flights were found.

[United States Airport Delays and Flight Status](#)

Flight Tracker by FlightAware



### 5-Day Forecast for ZIP Code 93454

[Customize Your Icons!](#)

Thursday	Friday	Saturday	Sunday	Monday
70° F   49° F	77° F   50° F	79° F   52° F	76° F   52° F	76° F   52° F
Partly Cloudy	Clear	Partly Cloudy	Clear	Clear
<a href="#">Hourly</a>	<a href="#">Hourly</a>	<a href="#">Hourly</a>	<a href="#">Hourly</a>	<a href="#">Hourly</a>

Today is forecast to be **nearly the same** temperature as yesterday.

### Forecast for Santa Barbara County Central Coast



Updated: 2:30 PM PDT on September 9, 2010

No Active Advisories ([US Severe Weather](#))

- Tonight**  
Mostly clear except for patchy low clouds and fog after midnight. Lows in the mid 40s to lower 50s. Northwest winds 15 to 25 mph in the evening.
- Friday**  
Sunny except for patchy morning low clouds and fog. Highs from the mid 60s to lower 70s at the beaches to the mid 70s to lower 80s inland.  
» [ZIP Code Detail](#)
- Friday Night**  
Clear except for patchy low clouds and fog after midnight. Lows in the mid 40s to lower 50s.
- Saturday**  
Areas of low clouds and fog in the morning then sunny. Highs from the mid 60s to lower 70s at the beaches to the mid 70s to lower 80s inland.  
» [ZIP Code Detail](#)
- Saturday Night**  
Clear except for patchy low clouds and fog after midnight. Lows in the upper 40s to mid 50s.
- Sunday through Tuesday**  
Areas of morning and night low clouds and fog...otherwise clear. Highs from the 60s at the beaches to the 70s to near 80 inland. Lows in the upper 40s to mid 50s.
- Tuesday Night through Thursday**  
Clear except for patchy night through morning low clouds and fog. Lows in the upper 40s to mid 50s. Highs from the 60s at the beaches to the 70s to around 80 inland.

Alternate Computer Forecast: [AVN MOS Weather Graph](#)

[Scientific Forecaster Discussion \(NWS\)](#)

### Air quality Forecast for Santa Maria



	Air quality:	AQ Index:	Pollutant:
Yesterday	Good		<a href="#">OZONE</a>
<b>Current</b>	<b>Good</b>		<a href="#">OZONE</a>
Thursday	Good		<a href="#">PM2.5</a>
Thursday	Good		<a href="#">OZONE</a>
Friday	Good		<a href="#">PM2.5</a>
Friday	Good		<a href="#">OZONE</a>

Want to learn more about air pollution? [Visit our health section.](#)

[Pollen Forecast](#) | [Current Air Quality](#) | [Yesterday's Peak](#)

### Earthquake Activity



City:      Distance to Epicenter:      Magnitude:      Date:  
Pinnacles, CA    123 miles      3.1      11:59 PM PDT 2010-09-08

Minimum magnitude displayed is 2.5. For more information, visit [USGS](#).

### Sports Weather



## Santa Maria, California

Local Time: 11:51 AM PDT (GMT -07) — [Set My Timezone](#)

Lat/Lon: **34.9° N 120.3° W** ([Google Map](#))

Tropical Weather: [Tropical Storm Igor](#) (North Atlantic) [Invest 92](#) (North Atlantic) [Invest 95](#) (Central Pacific)

### Current Conditions

Santa Maria, California (PWS)

Updated: 48 sec ago



**72.6 °F**  
Clear

Humidity: 57%

Dew Point: 56 °F

Wind: 8.0 mph from the WNW

Wind Gust: 8.0 mph

Pressure: 29.97 in (Steady)

Heat Index: 77 °F

Visibility: 10.0 miles

UV: 3.2 out of 16

Pollen: 8.00 out of 12  
[Pollen Forecast](#) NEW!

Clouds: Clear -  
(Above Ground Level)

Elevation: 0 ft

#### Rapid Fire Updates:

Enable  Disable

#### Source for Current Conditions:

PWS & Airport  Airport Only

[» Weather History for This Location](#)

Select a source for your current conditions:

Santa Maria, CA

[Raw METAR](#) [Aviation](#) [Weather Radio](#)

Flight Rule: **VFR (KSMX)**  
Wind Speed: **5.0** kts.  
Wind Dir: **289° (WNW)**  
Ceiling: **Unlimited**

[Full Report](#) — [Pilot Maps](#)



**Self Serve Advertising!**  
Promote your business to your local community on wunderground.com. Try us today with a free \$50 credit!

[click to learn more](#)

### Nearby Airports

City:	Temp.:	Conditions:	Updated:
<a href="#">» Santa Maria</a>	73 °F	Clear	10:51 AM PDT
<a href="#">Lompoc</a>	72 °F	Clear	11:35 AM PDT
<a href="#">Vandenberg AFB</a>	66 °F	Clear	10:55 AM PDT

### Flight Tracker Arrivals

Flight: From: To: ETA: Status:  
No flights were found.

[United States Airport Delays and Flight Status](#)

Flight Tracker by FlightAware



### 5-Day Forecast for ZIP Code 93454

[Customize Your Icons!](#)

Friday	Saturday	Sunday	Monday	Tuesday
74° F   50° F	76° F   52° F	77° F   52° F	72° F   52° F	70° F   52° F
Clear	Partly Cloudy	Partly Cloudy	Clear	Clear
<a href="#">Hourly</a>	<a href="#">Hourly</a>	<a href="#">Hourly</a>	<a href="#">Hourly</a>	<a href="#">Hourly</a>

Today is forecast to be **Warmer** than yesterday.

### Forecast for Santa Barbara County Central Coast



Updated: 3:18 am PDT on September 10, 2010



No Active Advisories ([US Severe Weather](#))

#### Today



Sunny except for patchy morning low clouds and dense fog. Visibility one quarter mile or less in the morning. Highs from the 60s at the beaches to the mid 70s to lower 80s inland. West winds around 15 mph in the afternoon.  
[» ZIP Code Detail](#)



#### Tonight

Clear except for patchy low clouds and fog after midnight. Lows in the lower to mid 50s. Northwest winds around 15 mph in the evening.



#### Saturday

Areas of low clouds and fog in the morning then sunny. Highs from the lower to mid 60s at the beaches to the upper 70s to mid 80s inland.  
[» ZIP Code Detail](#)



#### Saturday Night

Clear except for patchy low clouds and fog after midnight. Lows in the lower to mid 50s.



#### Sunday

Areas of low clouds and fog in the morning then sunny. Highs from the 60s at the beaches to the mid 70s to lower 80s inland.  
[» ZIP Code Detail](#)



#### Sunday Night

Clear except for patchy low clouds and fog after midnight. Lows in the lower to mid 50s.



#### Monday through Tuesday

Areas of morning and night low clouds and fog...otherwise clear. Highs from the upper 50s to mid 60s at the beaches to the mid 70s to lower 80s inland. Lows in the lower to mid 50s.



#### Tuesday Night through Thursday

Clear except for patchy night through morning low clouds and fog. Lows in the lower to mid 50s. Highs from the lower to mid 60s at the beaches to the upper 70s to mid 80s inland.

Alternate Computer Forecast: [AVN MOS Weather Graph](#)

[Scientific Forecaster Discussion \(NWS\)](#)

### Air quality Forecast for Santa Maria



	Air quality:	AQ Index:	Pollutant:
Yesterday	Good		<a href="#">OZONE</a>
Current	Good		<a href="#">OZONE</a>
Friday	Good		<a href="#">PM2.5</a>
Friday	Good		<a href="#">OZONE</a>

Want to learn more about air pollution? [Visit our health section.](#)

[Pollen Forecast](#) | [Current Air Quality](#) | [Yesterday's Peak](#)

### Sports Weather



NFL:	Date:	Forecast:
<a href="#">Dolphins vs. Bills</a>	1:00 PM EDT on September 12, 2010	Chance of Rain, 67 °F
<a href="#">Lions vs. Bears</a>	12:00 PM CDT on September 12, 2010	Clear, 74 °F



**Appendix K**

**CARB Independent Source Test Contractor Certificate**

State of California  
**Air Resources Board**  
Approved Independent Contractor

**Total Air Analysis, Incorporated**

This is to certify that the company listed above has been approved by the Air Resources Board to conduct compliance testing pursuant to California Code of Regulations, title 17, section 91207, until June 30, 2011, for those test methods listed below:

ARB Source Test Methods:

- 1, 2, 3, 4, 5, 6, 20, 100 (CO, CO<sub>2</sub>, NO<sub>x</sub>, O<sub>2</sub>, SO<sub>2</sub>, THC)  
410A, 410B, 421, 422, 430



Alberto Ayala, Ph.D., M.S.E.  
Chief, Monitoring and Laboratory Division

State of California  
**Air Resources Board**  
Approved Independent Contractor

**Total Air Analysis, Incorporated**

This is to certify that the company listed above has been approved by the Air Resources Board to conduct compliance testing pursuant to California Code of Regulations, title 17, section 91207, until June 30, 2011 for those test methods listed below:

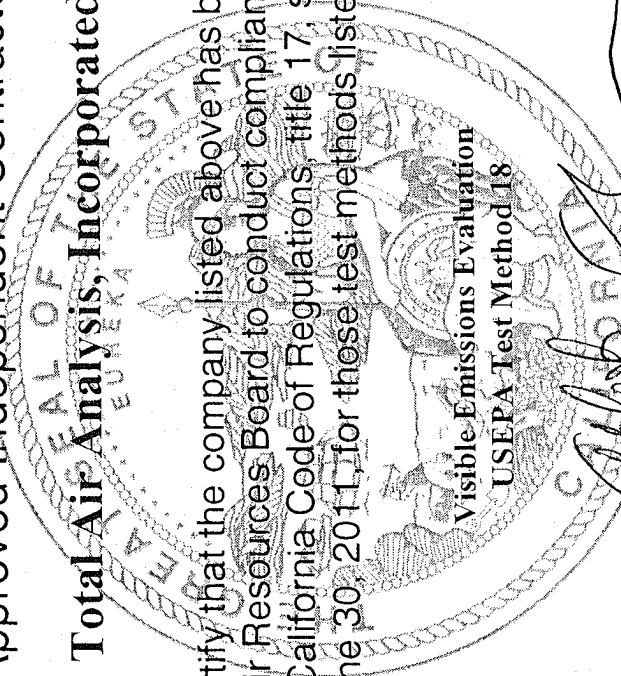

Visible Emissions Evaluation  
USEPA Test Method 18

Alberto Ayala, Ph.D., M.S.E.  
Chief, Monitoring and Laboratory Division